

Smitec S.p.A., via Carlo Ceresa 10, 24015 San Giovanni Bianco (BG), Italy, www.smitec.it



Installation, use and maintenance manual



BEFORE STARTING UP THE INDUSTRIAL PC OF FLXMOD MST S4 SERIES, CAREFULLY READ THIS MANUAL AND FOLLOW ALL INSTRUCTIONS, IN ORDER TO ENSURE MAXIMUM SAFETY

INDUSTRIAL PCs WITH SERCOS III BUS MASTER FLXMOD MST S4 SERIES



The technical data and the drawings in this manual might have been modified later; always refer to the latest version.

Summary

1 Preface	4
2 General warnings	5
3 Safety instructions	7
3.1 General information	7
3.2 Precautions during handling and assembly	7
4 Product description	8
4.1 Pictures of MST S4 module	8
5 Technical data	10
5.1 Environmental specifications	10
5.2 Electrical specifications	10
5.3 Mechanical specifications	11
5.3.1 Mechanical dimensions	11
5.3.1.1 Front view	11
5.3.1.2 Rear view	12
5.3.1.3 Top view	13
5.3.1.4 Bottom view	14
5.4 Hardware features	15
5.4.1 Basic Hardware	15
5.5 Order codes	16
5.6 Accessories	16
6 Connections and LEDs	17
6.1 Front view	17
6.1.1 Connection references	17
6.1.2 Signalling LEDs	17
6.1.2.1 STS status LED behavior	18
6.2 Top view	18
6.2.1 Connection references	19
6.3 Bottom view	19
6.3.1 Model with double Ethernet port	19
6.3.2 Connection references	19
6.3.3 Model with single Ethernet port	20
6.3.4 Connection references	20
6.4 24V IN supply connector	21
6.5 Sercos III connectors	22
6.6 USB port	23
6.7 Ethernet ports	23
6.7.1 Modules with cod. KZ010631 and KZ010690	23
6.7.2 Modules with cod. KZ010512, KZ010516, KZ010607, KZ010700 and KZ010734	24
6.7.3 LED behavior of communication speed signaling	25
6.7.4 LED behavior for signaling connection and communication activities	25
6.8 Housing socket of CFast card memory and micro SD (MSD) memory	26
6.9 Reset button	26
7 Installation	27
7.1 Assembly	27
7.2 Environmental requirements	28
7.3 Electrical wiring	28
8 Use	29
8.1 CFast card	29
8.2 Micro SD card	29
8.3 Priority of the start-up devices	30
9 Ordinary maintenance	31
9.1 Clock battery replacement	31

10 Appendices	34
10.1 Appendix I: CMOS Setup parameters	34
11 Analytical index	35

1 Preface

This manual provides all necessary information for the installation, use and maintenance of FLXMOD MST S4 modules.

The instructions included in this manual are addressed to the following professionals:

User	User is a person, a company or an institution that buys the equipment and uses it for the purposes it was designed for.
User/operator	User or operator is a person authorized by the user to operate on the equipment.
Specialized personnel	It refers to all persons with specific competence, able to recognize and avoid the dangers deriving from the use of the equipment.

The present instructions must be made available to all the above individuals.





2 General warnings

These assembly instructions are an integral part of the equipment, and must be kept for future reference until decommissioning.

The user should be informed that the present instructions reflect the state of the art at the moment when the equipment was sold; they will remain fully acceptable despite subsequent upgrades based on new experiences.

	<p>DO NOT USE THE EQUIPMENT, NOR MAKE ANY INTERVENTION BEFORE INTEGRALLY READING AND UNDERSTANDING THIS MANUAL.</p>
<p>IN PARTICULAR, ADOPT ALL SAFETY PRECAUTIONS AND PRESCRIPTIONS INDICATED IN THIS MANUAL.</p>	
<p>THE EQUIPMENT CANNOT BE USED FOR PURPOSES DIFFERENT THAN THE ONES DESCRIBED IN THIS MANUAL; SMITEC S.p.A. SHALL NOT BE HELD RESPONSIBLE FOR ANY DAMAGES, INCONVENIENCES OR ACCIDENTS DUE TO THE NON-COMPLIANCE WITH THESE PRESCRIPTIONS.</p>	

In order to make the manual consultation easier, the following symbols have been adopted:



	<p>Indication of "PROHIBITED ACTION".</p>
	<p>The symbol "DANGER" is used when the non-respect of the prescriptions or the tampering of organs can cause serious harm to people or things.</p>
	<p>The symbol "USE OF INDIVIDUAL PROTECTIONS" means that protective gloves must be worn.</p>
	<p>Indication of "INFORMATION OF PARTICULAR RELEVANCE".</p>

The safety prescriptions aim at establishing a series of behaviors and obligations to be complied with, while performing the activities described later on in this manual.



These prescriptions constitute the prescribed method of operating the device, in a way that is safe for personnel, equipments and environment.

3 Safety instructions

3.1 General information

	<p>Do not install or use the equipment before integrally reading and understanding this manual. In case of difficulties of interpretation, contact SMITEC technical service.</p> <p>It is absolutely forbidden to use the equipment for different purposes than the ones described in this manual. The technical data and the drawings in this manual might have been modified later; always refer to the latest version. All upgrades can be requested to SMITEC S.p.A. directly.</p>
	<p>Make sure that the personnel is qualified and adequately informed about the risks he may run and how to avoid them.</p>
	<p>FLXMOD MST S4 industrial PCs can be used only after the classification of the machine operating area and after checking the safety levels, which must correspond to the assembly safety levels.</p>

3.2 Precautions during handling and assembly

	<p>Use adequate tools during the assembly, in order to avoid crushing or abrasions.</p>
	<p>Metal components and sharp surfaces may cause cuts and tears. In case of contact, be very careful and wear the personal protection equipment.</p>

4 Product description

The MST S4 module is an industrial PC based on an Intel® 64 architecture with integrated SERCOS III bus master. Housed in a very compact plastic case, it has been designed to be installed on a standard DIN rail and to be perfectly integrated in a FLXMOD automation system. It is an ideal complement to create an automation system based on SERCOS III field-bus and on FLXMOD™ modules.

The MST S4 calculation capability relies on Quad Core Intel® Atom™ x5-E8000 (1.04GHz) processor with 2GB 1600MT/s DDR3L RAM memory.

In order to meet the more different needs of interfacing, the MST S4 offers the possibility to connect standard input/output peripheral units, such as keyboard, mouse, track ball, monitor, etc.

The module MST S4 can communicate with the external world via one USB 3.0 port, 1 or 2 10/100/1000 Mb Ethernet ports depending on the model and one single channel DVI-D port. It also integrates one socket for connecting a micro SD memory and one socket for connecting a CFast memory, ideal for operating system, data and programs storage, because it is a solid-state, high-speed flash memory, with exceptional resistance to accidental shocks and vibrations. Some models are supplied complete with CFast memory, operating system and programs.

The CFast memory position inside the MST S4 is designed to be removed without opening the module.

4.1 Pictures of MST S4 module



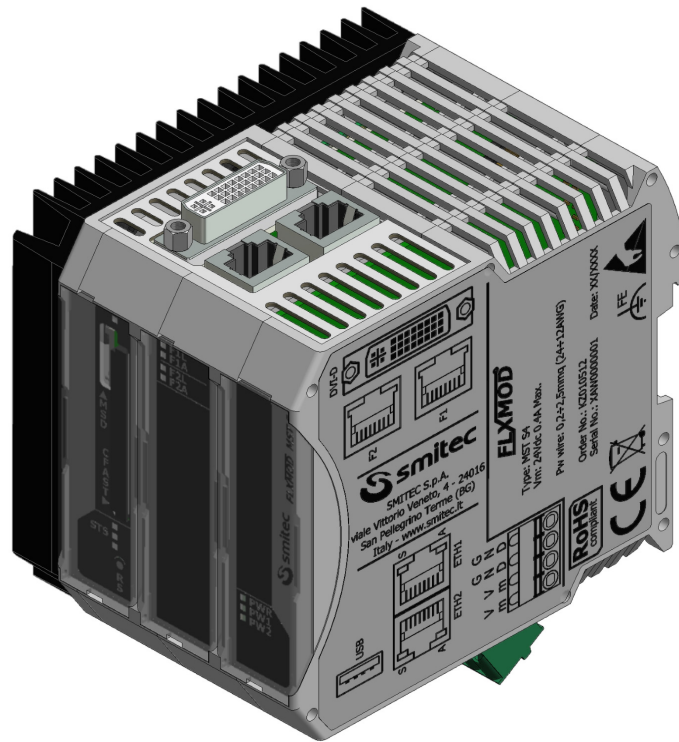

5 Technical data



All the technical data in this section correspond to the hardware configuration of the MST S4 manufactured on the date when this manual was drawn up. To improve or update this product, SMITEC S.p.A. reserves the right to modify its technical features without notice.

5.1 Environmental specifications

Operating temperature	0° ÷ +40°C when it is operating
Storage temperature	-20° ÷ +85°C when it is not operating
Relative humidity	0 ÷ 95% (without condensation)
Housing	Polyamide (PA66) and aluminum
Protection degree	IP20 according to IEC 60529
Altitude (operation)	Up to 2000 m above sea level (corresponding to an atmospheric pressure from 80 to 106 kPa)
Altitude (storage and transportation)	Up to 3000 m above sea level (corresponding to an atmospheric pressure from 70 to 106 kPa)

5.2 Electrical specifications

The specifications below refer to the MST S4 unit alone, without any peripheral unit connected.

Mains voltage	24 VDC (- 15% ÷ +20% according to EN 61131-2)
Absorbed current	Max 0.50A @ 24VDC
Absorbed power	Max 12W
Ripple	Max 5% of the supply voltage according to EN 61131-2

5.3 Mechanical specifications

Fastening	Installed on standard DIN rail
Weight	530g

5.3.1 Mechanical dimensions

5.3.1.1 Front view

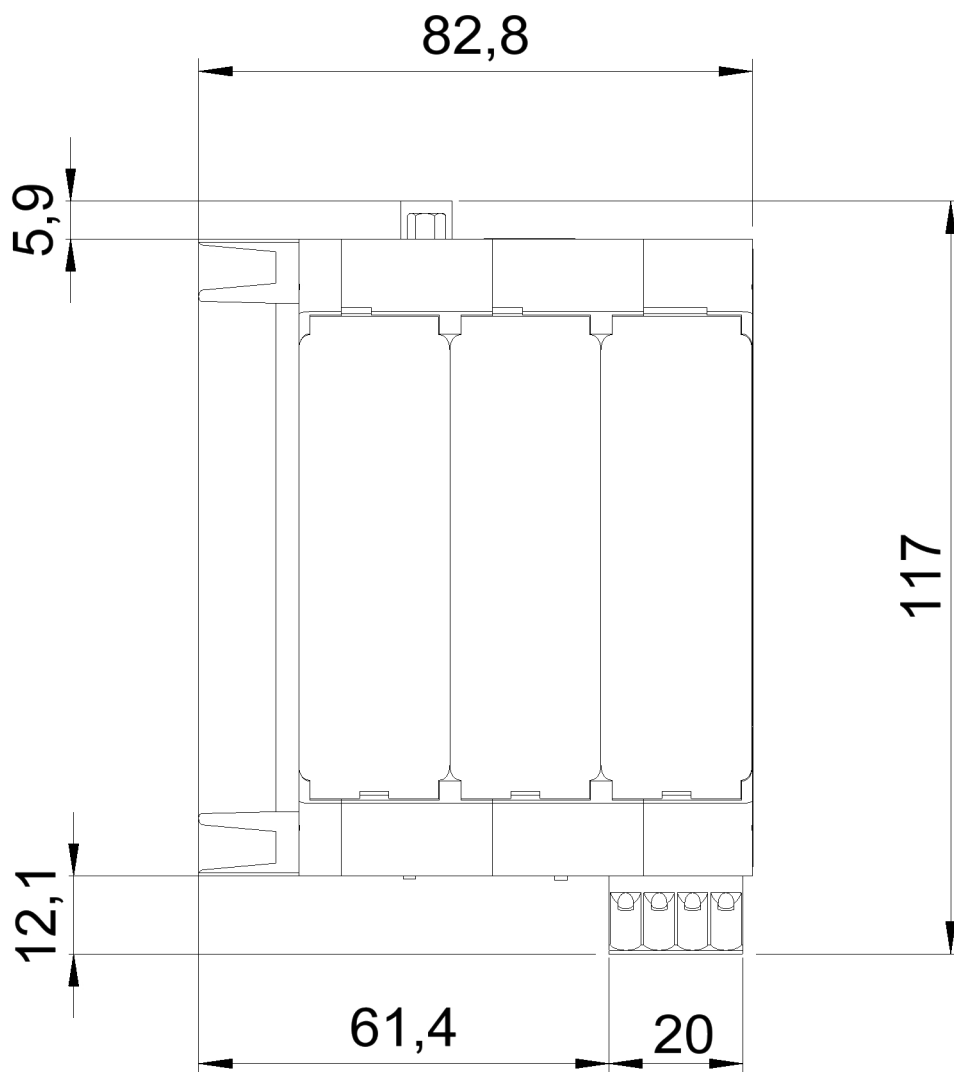

5.3.1.2 Rear view

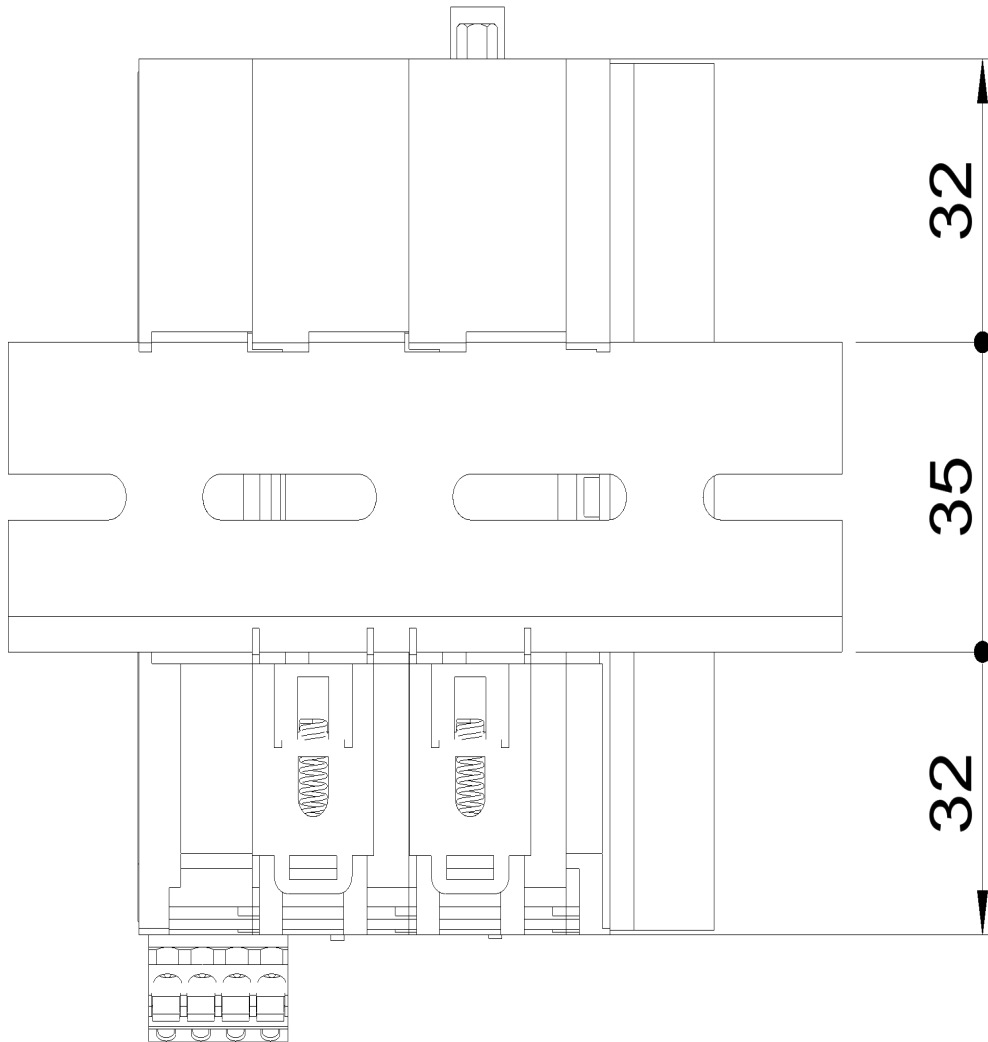

5.3.1.3 Top view

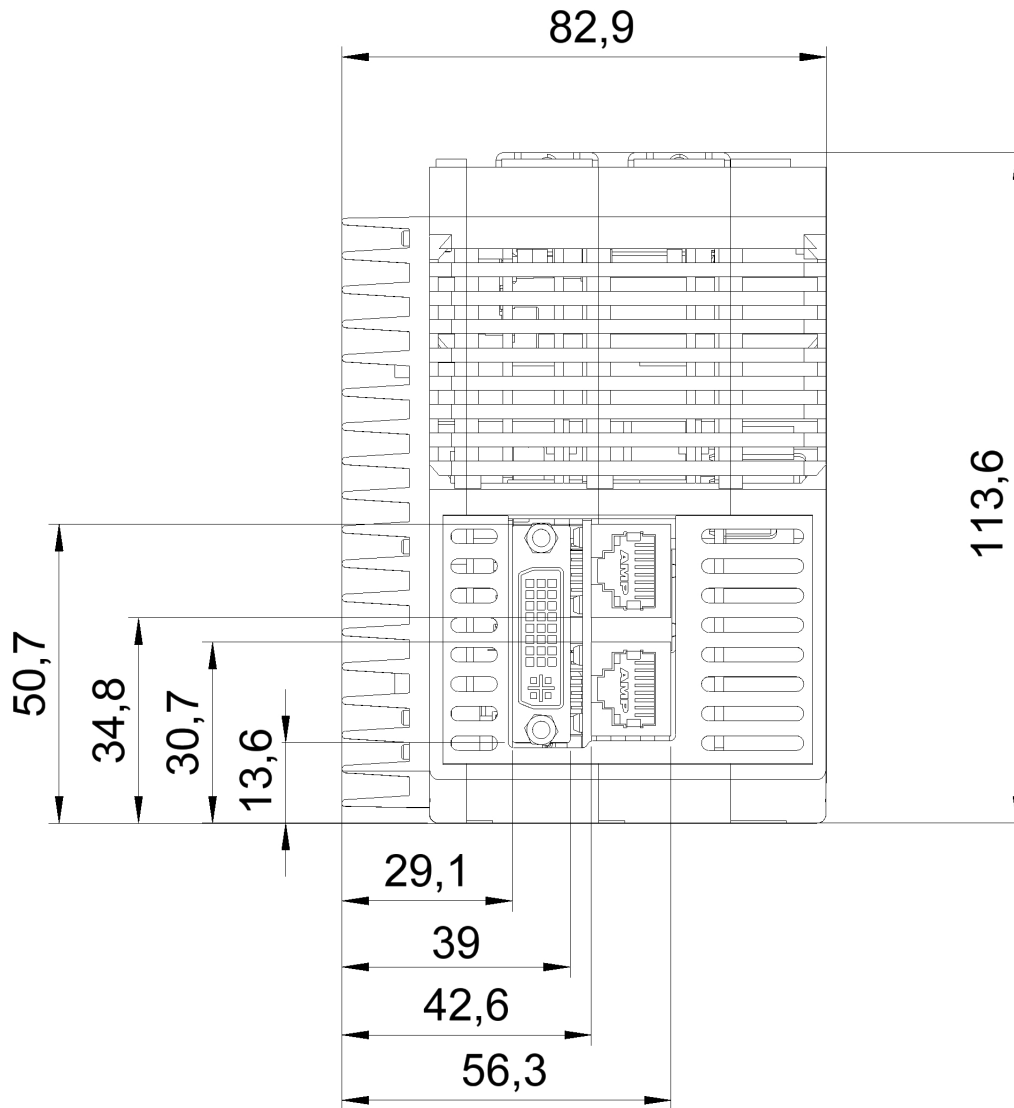

5.3.1.4 Bottom view

In the following image, the MST module with two Ethernet ports is shown; mechanical dimensions are identical to the model with only one Ethernet port.

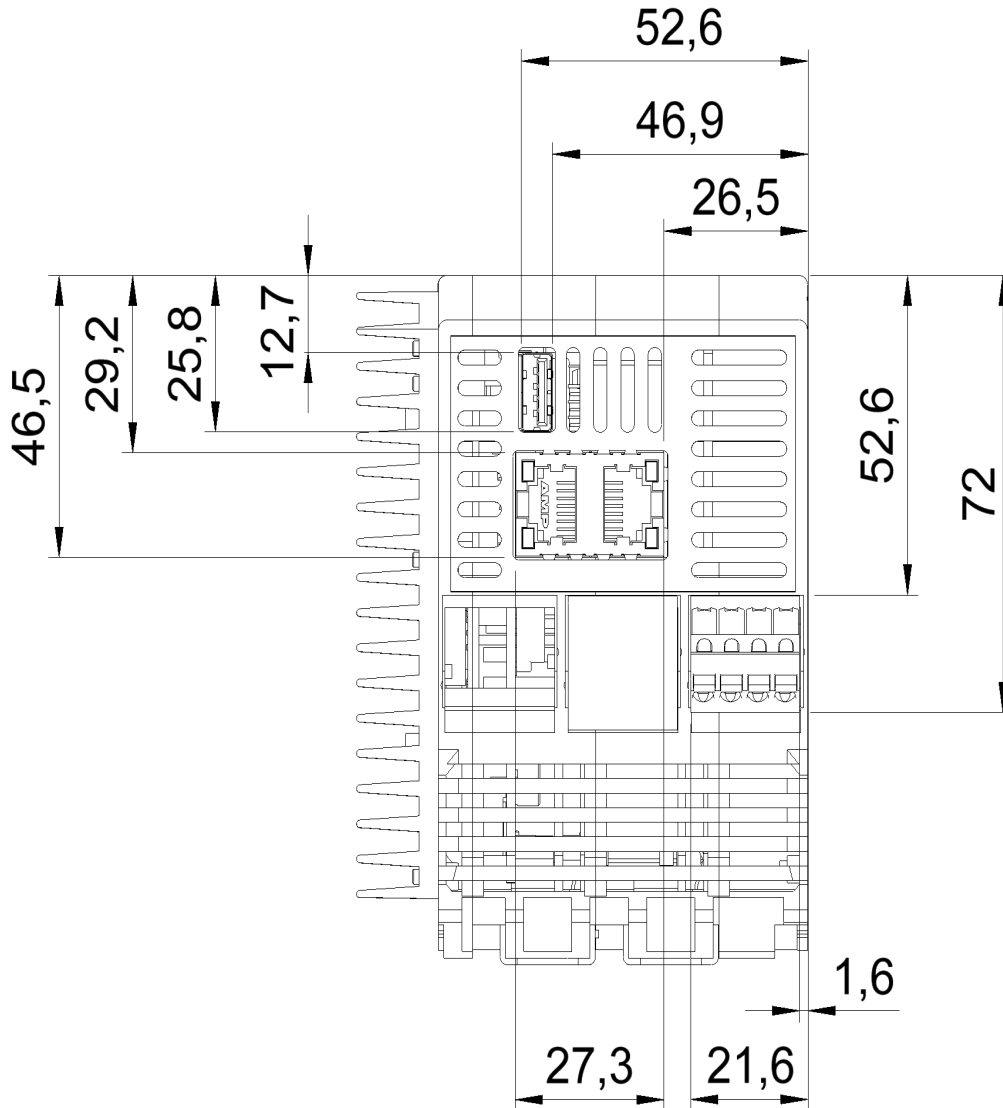

5.4 Hardware features



The below features correspond to the hardware minimum configuration supplied with the product and tested from a functional point of view; any additional peripheral unit eventually available in the actual product is not guaranteed, neither from an operational nor from a functional point of view.

5.4.1 Basic Hardware

Processor	Quad Core Intel® Atom™ x5-E8000 (1.04GHz)
Memory	2GB 1600MT/s DDR3L RAM
Operating systems available	Microsoft®Windows 10 IoT Enterprise / Linux
Architecture	Intel® 64
Graphics	Single channel DVI-D output (default digital video output, set with a 1024*768 pixel resolution)
Field Bus	1 x SERCOS III master (line and ring topology)
Connections and functions	1 x DVI-D output on connector type DVI-I (top side)
	1 x USB 3.0 (bottom side)
	1 or 2 x Ethernet 10/100/1000 Mb (bottom side; for cod. KZ010512, KZ010516, KZ010607, KZ010700 e KZ010734)
	2 x Ethernet 10/100/1000 Mb (bottom side; only for cod. KZ010631 and KZ010690)
	1 x CFast socket (front side)
	1 x uSD socket (front side)
	1 x reset button (front side)
	3 x programmable LEDs (front side)

5.5 Order codes

Order code	Model	Description
KZ010512	MST S402	FLXMOD - MST S4 - DIAGOS+FLXCORE (32-bit Linux OS)
KZ010516	MST S402	FLXMOD - MST S4 - FLXCORE (32-bit Linux OS)
KZ010607	MST S402	FLXMOD - MST S4 - FLXCORE (32-bit Linux OS)
KZ010631	MST S402	FLXMOD - MST S4 - DIAGOS+FLXCORE (64-bit Linux OS)
KZ010690	MST S402	FLXMOD - MST S402 - DIAGOS+FLXCORE (64-bit Linux OS)
KZ010700	MST S402	FLXMOD - MST S4 - FLXCORE (32-bit Linux OS)
KZ010734	MST S402	FLXMOD - MST S4 - DIAGOS+FLXCORE (32-bit Linux OS)

5.6 Accessories

The industrial computers MST S4 are supplied complete with power supply connector and, where provided, mass storage memories. These items can also be ordered separately, like the other accessories not included in the MST S4 module.

Here is a list of the order codes:

Order code	Item
KF100009	24VDC detachable connector (Phoenix Contact, cod. 1910377)
KE020045	Flash disk CFast type, 64GB capacity (empty)
KE020031	Flash disk CFast type, 32GB capacity (empty)
KE020038	Flash disk CFast type, 16GB capacity (empty)
KE020039	Flash disk CFast type, 8GB capacity (empty)
KE050065	CFast Card 64 GB with DIAGOS+FLXCORE (32 bit)
KE050083	CFast Card 64 GB with FLXCORE (32 bit)
KE050124	CFast Card 64 GB with DIAGOS+FLXCORE (64 bit)
TB010554	CR2032 button battery

6 Connections and LEDs

6.1 Front view

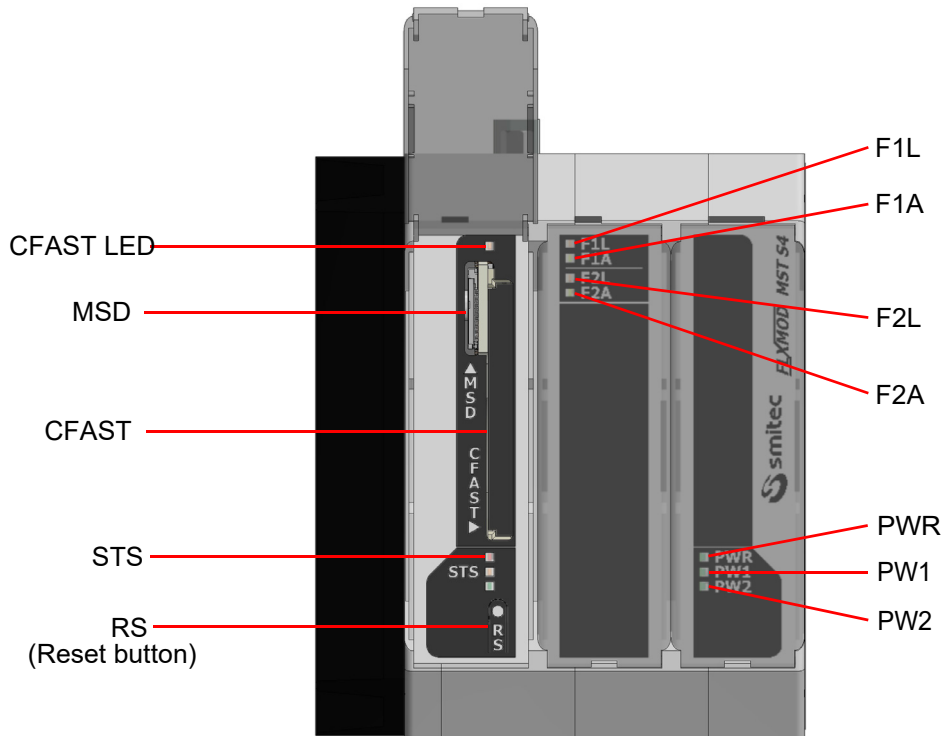

6.1.1 Connection references

Name	Function
CFAST	Socket for CFast memory
MSD	Socket for micro SD memory

6.1.2 Signalling LEDs

Name	Function
PWR	It indicates that the 24VDC main power supply is present and the protective fuse is not blown
PW1	It indicates that the internal power supply 1 (5VDC) is present
PW2	It indicates that the internal power supply 2 (24VDC) is present

F1L	It indicates successful connection with port 1 through protocol Sercos III
F1A	It indicates data exchange with port 1 through protocol Sercos III
F2L	It indicates successful connection with port 2 through protocol Sercos III
F2A	It indicates data exchange with port 2 through protocol Sercos III
CFAST LED	It indicates the system's access to the CFast memory
STS	It indicates the system current status through programmable LEDs

6.1.2.1 STS status LED behavior

The operating status of the device is signaled by a series of possible ON / OFF combinations of the STS LEDs, which are managed by specific dedicated software.

The different LEDs behaviors to which a specific function corresponds are listed below:

- Red LED ON, Orange and Green LEDs OFF: the system is defective
- Red LED ON, orange and green LEDs flash simultaneously, then the green LED flashes once, again the orange and green LEDs start flashing again and so on: the application software is not running or the operating system has not started
- Red, orange and green LEDs ON: the system is starting up
- Red LED flashes rapidly, orange and green LEDs OFF: the system is updating the internal firmware

6.2 Top view

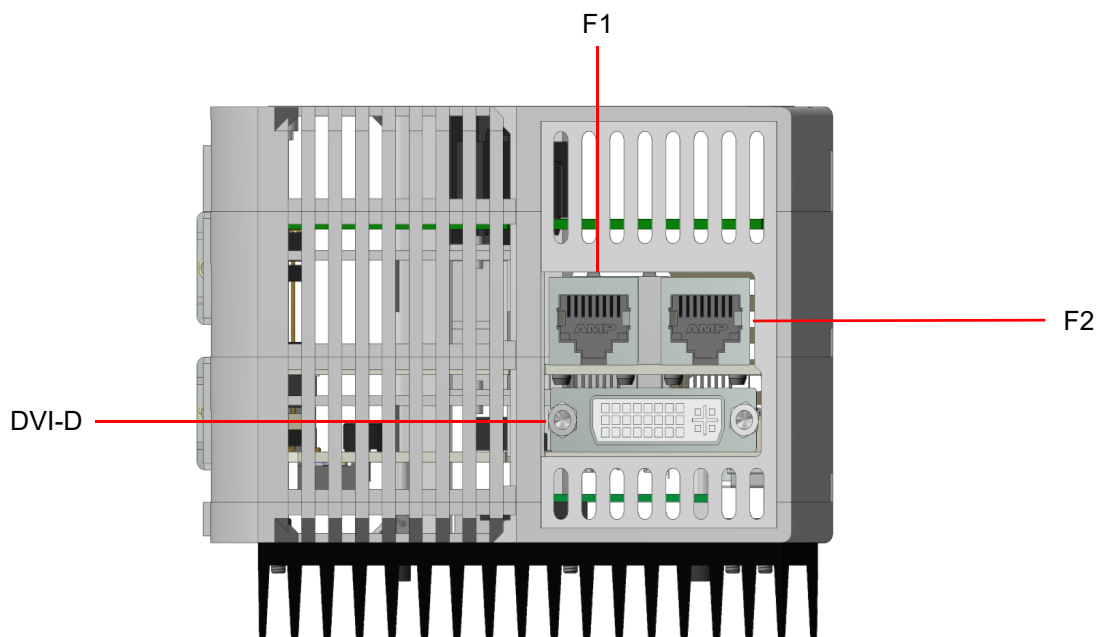

6.2.1 Connection references

Name	Function
DVI-D	Digital video port for external monitors
F1	RJ45 communication port 1 for Sercos III
F2	RJ45 communication port 2 for Sercos III

6.3 Bottom view

6.3.1 Model with double Ethernet port

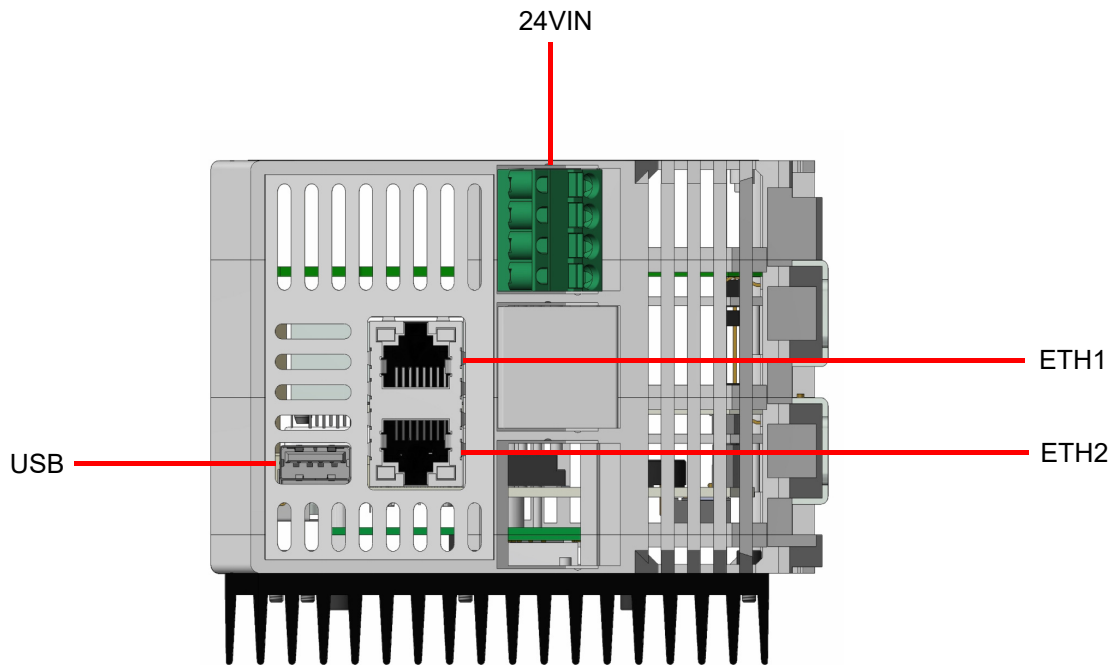

6.3.2 Connection references

Name	Function
ETH1	Ethernet communication port 1
ETH2	Ethernet communication port 2
USB	USB 3.0 port
24VIN	Input for 24VDC main power supply

6.3.3 Model with single Ethernet port

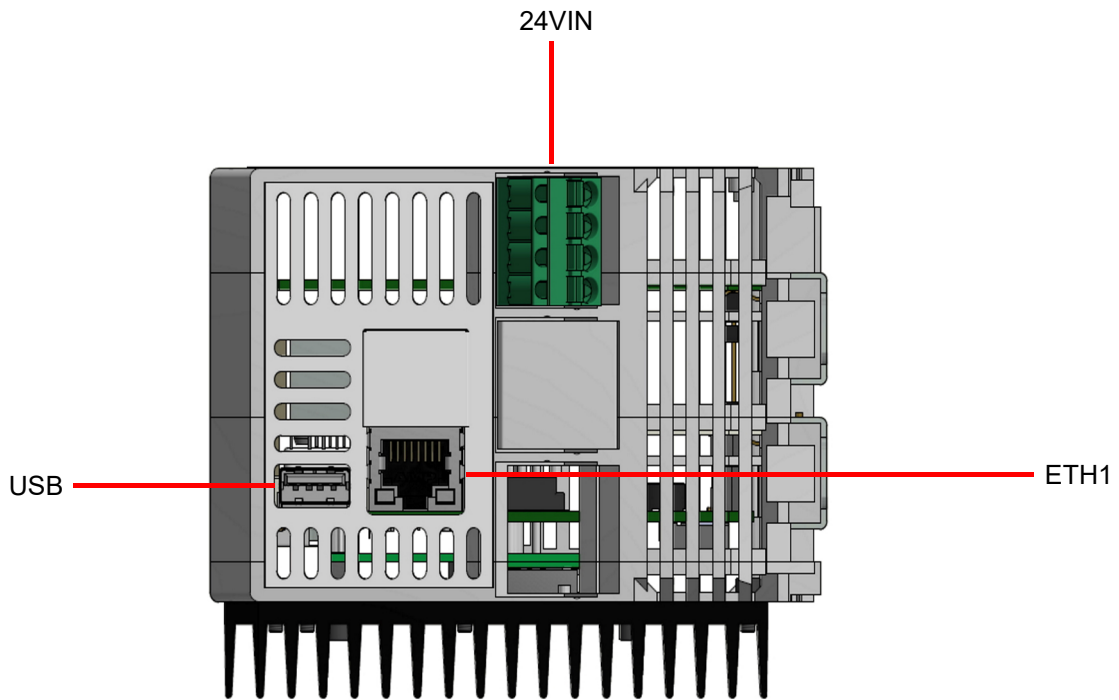

6.3.4 Connection references

Name	Function
ETH1	Ethernet communication port 1
USB	USB 3.0 port
24VIN	Input for 24VDC main power supply



6.4 24V IN supply connector

The connector which powers the MST S4 module features spring contacts, in order to make the wiring of single cables easier.

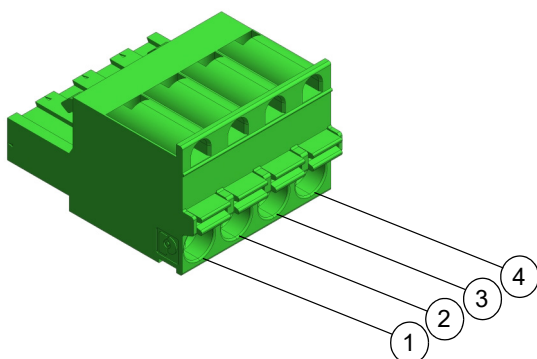
Connector type: Phoenix Contact FKCT 2,5/4-ST (1910377)				
Order code: KF100009				
Features		Conductors cross section		
Connection in accordance with	EN-VDE	Solid min.	0,2 mm ²	24 AWG
Rated voltage	250 V	Solid max.	2,5 mm ²	12 AWG
Rated current	12 A	Stranded min.	0,2 mm ²	24 AWG
		Stranded max.	2,5 mm ²	12 AWG
Insulating material	PA	Stranded, with ferrule without plastic sleeve min.	0,25 mm ²	24 AWG
Inflammability class according to UL 94	V0	Stranded, with ferrule without plastic sleeve max.	2,5 mm ²	12 AWG
Stripping length	10 mm	Stranded, with ferrule with plastic sleeve min.	0,25 mm ²	24 AWG
Screwdriver to be used for opening the connections	0,6x3,5 mm	Stranded, with ferrule with plastic sleeve max.	2,5 mm ²	12 AWG



Supply 24V	
Pin	Signal
1	+24 Vdc
2	+24 Vdc
3	GND
4	GND

	<p>Use an adequately sized wire, according to the current flowing. A lower cross-section might cause fire, due to overheating caused by the wire.</p>
	<p>In order to meet the requirements of the EMC 2014/30/UE, the cable must not be longer than 30 meters.</p>
	<p>The MST S4 module is a high-tech electronic device, sensitive to electrostatic discharges (ESD). Take maximum care to prevent such discharges, by adhering to the prescriptions of the law, in order to avoid damages to the device.</p>

6.5 Sercos III connectors

The device features two connectors Sercos III, installed on the upper side of the device, used for the communication with other devices equipped with SIII field-bus interface. As specified in the standard protocol Sercos III, there is no functional difference in using connector F1 or F2, therefore it is possible to connect the field-bus cables in any order. The pin configuration of the connectors is standard for Ethernet wiring; therefore, it is possible to use common Ethernet cables (min. FTP Cat. 5E) to connect the MST S4 module to Sercos III bus.

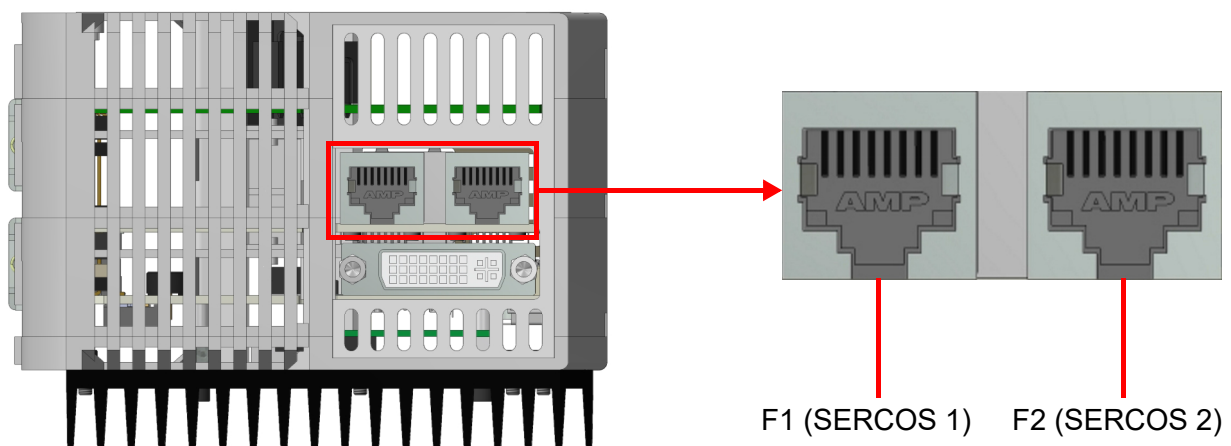

6.6 USB port

The USB connector is located on the underside of the module. The type of connector used is the most common type: type A USB 3.0. The USB 3.0 port is compatible with the USB 2.0 standard.

6.7 Ethernet ports

6.7.1 Modules with cod. KZ010631 and KZ010690

There are two 10/100/1000 Mbps Ethernet ports located at the bottom of the device which use standard RJ45 Ethernet connectors. It is therefore possible to use common Ethernet cables to connect the CPX 04XX module to the local network.

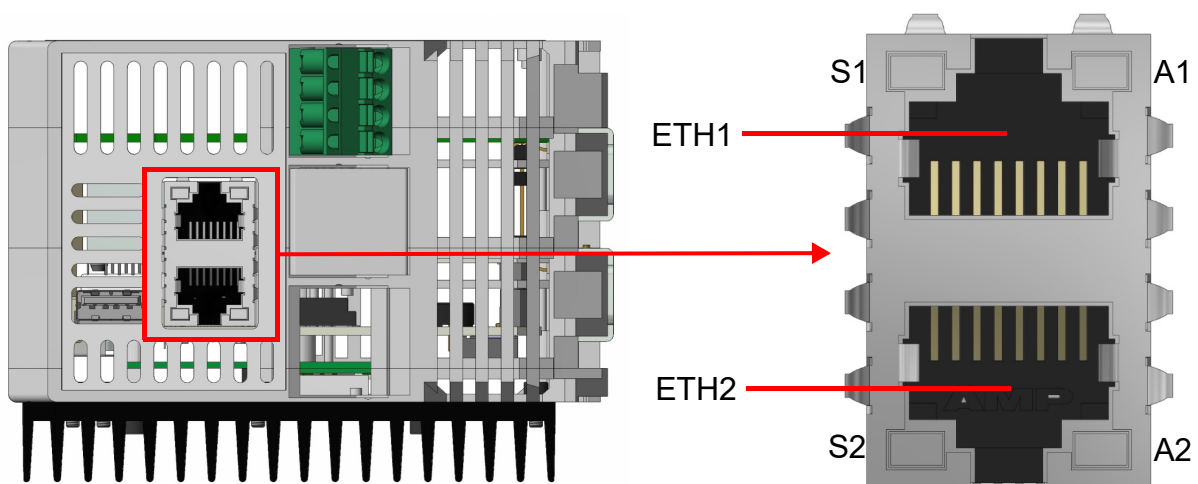

Each Ethernet port features two LEDs: the first one, identified by the letter S, indicates the communication speed of the concerned port. It is a bicolor lamp (green/orange); it changes its colour according to the communication speed of the Ethernet port.

The second one, identified by the letter A, indicates the activity of the port (whether it is connected or it is communicating).

6.7.2 Modules with cod. KZ010512, KZ010516, KZ010607, KZ010700 and KZ010734

Following technological evolutions, the KZ010512, KZ010516, KZ010607, KZ010700 and KZ010734 modules can be equipped with one or two Ethernet ports. The electrical characteristics are the same as described in paragraph 6.7.1 relating to cod. KZ010631 and KZ010690.

The two possible variants are shown below as the number of Ethernet ports:

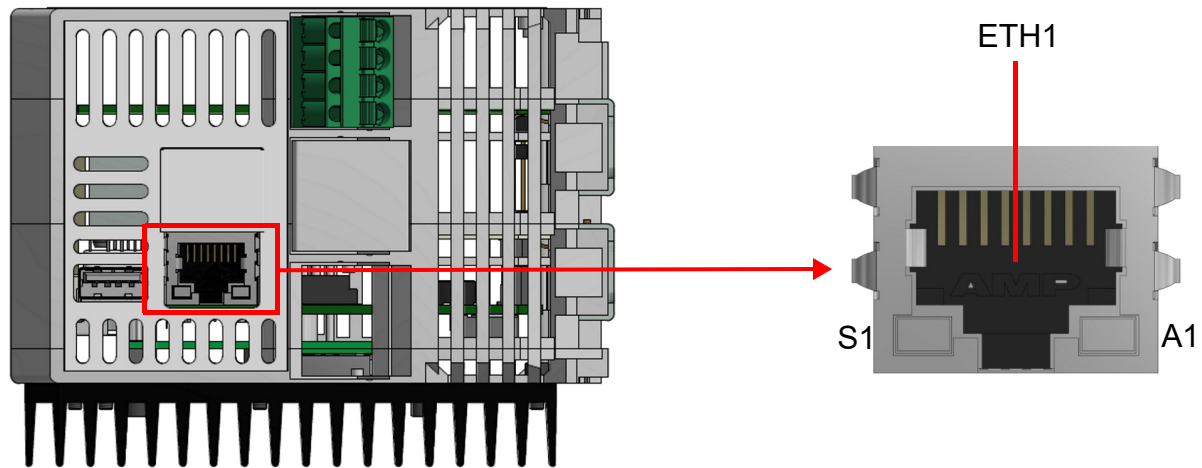
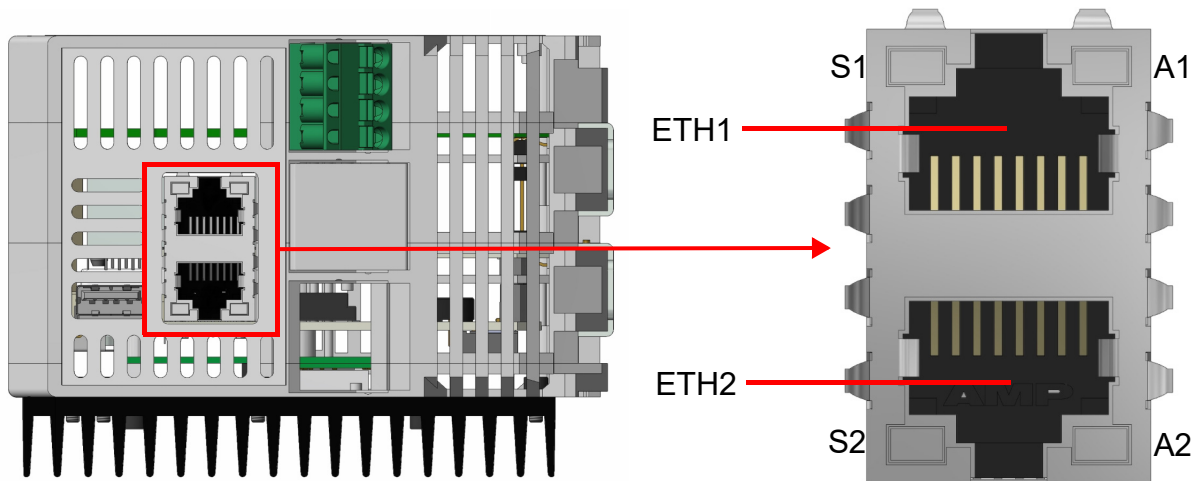

6.7.3 LED behavior of communication speed signaling

Below is a table summarizing the possible speed states of the Ethernet ports (for MST modules with a single Ethernet port do not consider the S2 reference in the table):

Name	State	Function
S1	OFF	Ethernet port S1 communicating at a speed equal to 10 Mbps/1 Gbps
S2	OFF	Ethernet port S2 communicating at a speed equal to 10 Mbps/1 Gbps
S1	ON (green LED)	Ethernet port S1 communicating at a speed equal to 100 Mbps
S2	ON (green LED)	Ethernet port S2 communicating at a speed equal to 100 Mbps
S1	ON (orange LED)	Ethernet port S1 communicating at a speed equal to 1 Gbps
S2	ON (orange LED)	Ethernet port S2 communicating at a speed equal to 1 Gbps

6.7.4 LED behavior for signaling connection and communication activities

Below is a table summarizing the possible connection and communication states of the Ethernet ports (for MST modules with a single Ethernet port do not consider the reference A2 in the table):

Name	State	Function
A1	OFF	A1 Ethernet port not connected
A2	OFF	A2 Ethernet port not connected
A1	ON (green or orange LED)	A1 Ethernet port connected and no activity
A2	ON (green or orange LED)	A2 Ethernet port connected and no activity
A1	BLINK OFF (green or orange LED)	A1 Ethernet port connected and active
A2	BLINK OFF (green or orange LED)	A2 Ethernet port connected and active

6.8 Housing socket of CFast card memory and micro SD (MSD) memory

The sockets for the CFast memory and for the SD memory are located on front of the device. These memories are installed inside the device, behind a transparent plastic cover.

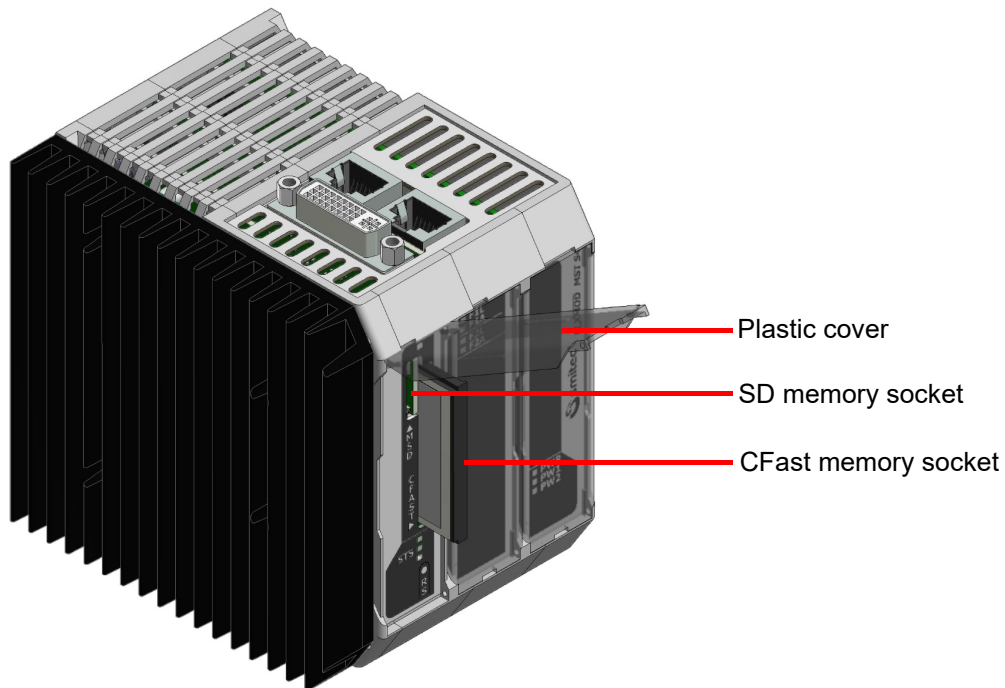



6.9 Reset button

The reset button allows the computer to be restarted immediately.



Pressing the button at an inappropriate time may result in data loss and/or damage to the operative system.
Use only if necessary.

7 Installation

	<p>During installation of the FLXMOD MST S4 computer, falls and violent shocks must be avoided which could compromise the smooth operation.</p>
	<p>Avoid touching the input / output connectors on the computer panel directly unless you are equipped with suitable static electricity protection equipment; any discharges on the connectors could damage the appliance.</p>
	<p>Always carry out all electrical connections when the equipment is switched off: this will prevent damage to the computer and danger to the operator (exceptions to connections to the USB ports are possible).</p>
	<p>Always make sure that all the devices connected to the MST S4 have an efficient grounding (if foreseen by the device). Failure to follow this precaution could result in damage to the computer and danger to the operator.</p>
	<p>Do not position the device so that it is difficult to disconnect the wiring connected to it.</p>

7.1 Assembly

The MST S4 module, like all modules belonging to the FlxMod system, are fixed to a DIN rail by means of a spring-loaded coupling system.

In the FlxMod system, functional grounding (FE) is simply performed by hooking the module to the DIN rail.

Below is an example image:

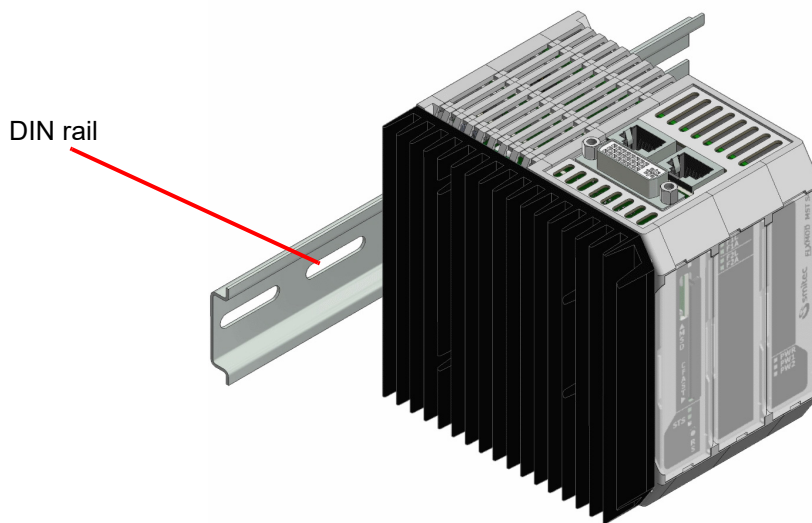

7.2 Environmental requirements

In order for the system to operate properly, the MST S4 module must remain within the temperature limits indicated in the specifications. This means that, inside the electrical cabinet where the module is installed, there should be a suited cooling system in order to keep the temperature within the correct limits.

7.3 Electrical wiring

The main connections for the MST S4 operation are the power supply and the earth; make these connections following the instructions on polarity, conductors and connectors stated in the chapter "Connections". Before switching on the computer, make sure that the mains voltage is within the parameters indicated in the specifications.

The device connection to the peripheral units is simplified by the use of standard computer connectors; this means that all standard peripheral for personal computers can be connected by means of the cable supplied with them or by means of commercial cables easily found on the market.

For connections to non-standard devices, such as inverters or other that require particular combinations of signals and cable lengths, it is possible to make them following the instructions stated in the chapter "Connections".

8 Use

8.1 CFast card

The CFast card of the MST S4 module replaces the traditional hard disk, thus ensuring better shock tolerance and longer life of the device, also in case of continuous working cycles.

The flash card positioning and its easy removal/insertion allow quick replacement, both in case of failure or software off-line upgrade.



In order to avoid damages to the computer and/or CFast card loss of data, always switch off the module MST S4 before replacing the flash card.

8.2 Micro SD card

The micro SD card of the MST S4 module replaces the traditional hard disk, thus ensuring better resistance to shocks and longer life of the device.

The micro SD card positioning and their easy removal/insertion allow quick replacement, both in case of failure or software off-line upgrade.



In order to avoid damages to the computer and/or micro SD card loss of data, always switch off the module MST S4 before replacing the micro SD cards.

8.3 Priority of the start-up devices

A boot device is the CFast card or USB flash disk, or other mass storage on which the operating system (for example Windows) is stored by which the computer boots.

By default, the search for the operating system takes place first in the CFast, then in a possible USB flash disk.

The first device among these, which contains the boot information that an operating system needs, is used.

Therefore, if you want to boot the computer in a different sequence, you need to remove the other possible boot devices (eg by ejecting the CFast).

For the BIOS operating mode belonging to the MST S4 module, the boot sequence automatically adapts to the number or serial number variations of the boot devices; in fact, new devices, that is not present when the computer was first turned on, are inserted as last in the start sequence.

9 Ordinary maintenance

9.1 Clock battery replacement

The backup battery in the MST S4 module powers the RTC circuit (real-time clock). The RTC is a real-time clock which remains active even when the device is off and constantly updates the date and time. According to the ambient temperature and to the computer use, the battery can have a markedly different duration, starting from the MST S4 production date.

When the user realizes that the battery is exhausted, it can replace it in a few simple steps:

- **STEP 1**

Lift the transparent cover

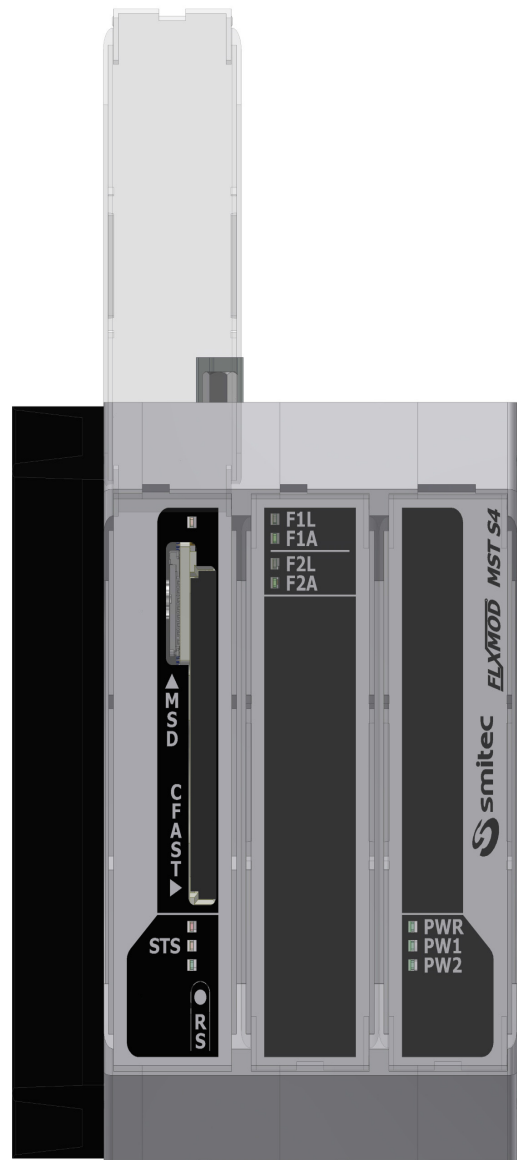

- STEP 2

With a tweezers, gently lift the silk-screened plastic plate and remove it

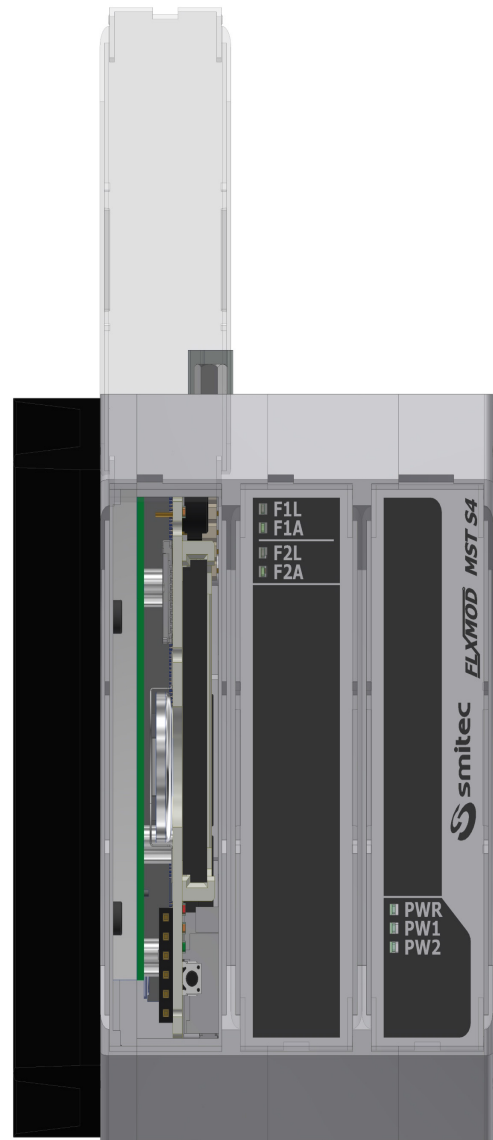

• STEP 3

Gently remove the battery with pliers, being careful not to drop it into the device

Insert the battery in the housing indicated in the figure, paying attention to the polarity and then to the direction in which the battery is inserted. See the following images:



Battery side with positive polarity (+):
the pole (+) is facing the computer heatsink



Battery side with negative polarity (-):
the pole (-) is facing the printed circuit of the internal card

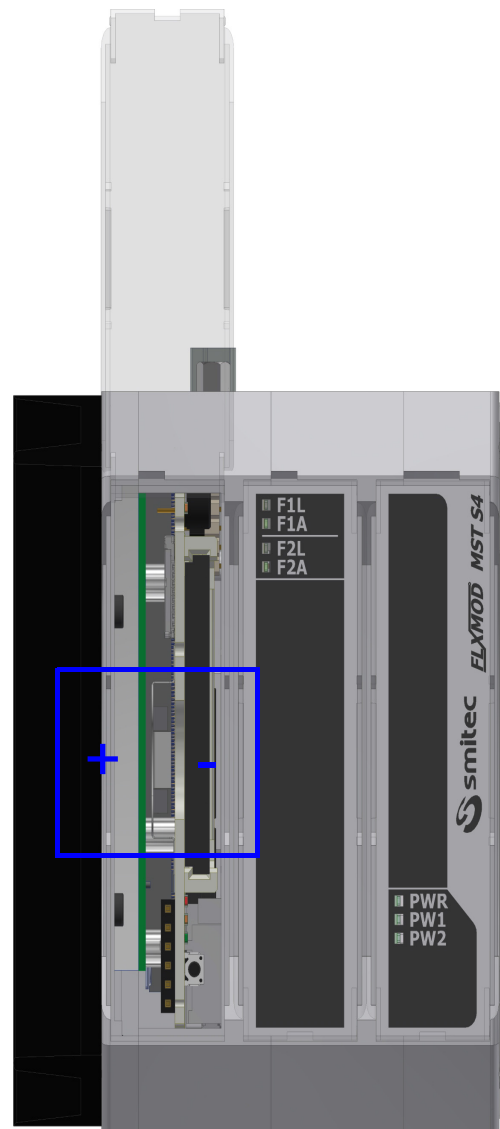

Once the new battery has been correctly inserted, repeat each operation described in every part inversely.

Then manually update the date and time using the operating system.

10 Appendices

10.1 Appendix I: CMOS Setup parameters

In the MST S4 module, the CMOS Setup parameters are stored in the BIOS and are password protected to guarantee operation.

In the event that a loss of the CMOS setup parameters occurs, for example due to running out of the buffer battery, these will automatically reset when the device is turned back on, while the date and time will have to be updated manually using the operating system.

If necessary, the CMOS setup password can be requested from the service department.

11 Analytical index

A		S	
Absorbed current	10	SERCOS III	8, 22
Absorbed power	10	Sercos III	22
Altitude	10		
Architecture	15	W	
Assembly	27	Weight	11
B			
Basic Hardware	15		
Button battery	16		
C			
CFast card	29		
Clock battery	31		
D			
DIN rail	8		
DVI-D	8		
E			
ESD	22		
F			
Fastening	11		
Field Bus	15		
FLXMOD	8		
G			
Graphics	15		
H			
Housing	10		
M			
Memory	15		
Micro SD card	29		
O			
Operating temperature	10		
Order codes	16		
P			
Processor	15		
Protection degree	10		
R			
RAM	8		
Relative humidity	10		
Ripple	10		
RTC	31		