

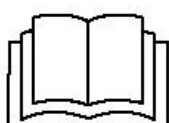

## Installation, use and maintenance manual



**BEFORE STARTING THE COSMOS 315X/325X/350X SERIES SERVO DRIVE, CAREFULLY READ THIS MANUAL AND FOLLOW ALL INSTRUCTIONS, IN ORDER TO ENSURE MAXIMUM SAFETY**

# SERVODRIVES

## COSMOS SERIES 315X/325X/350X



The technical data and the drawings in this manual might have been modified later; always refer to the latest version.

# CONTENTS

<b>1</b>	<b>PREFACE.....</b>	<b>6</b>
<b>2</b>	<b>GENERAL WARNINGS.....</b>	<b>7</b>
<b>3</b>	<b>SAFETY INSTRUCTIONS.....</b>	<b>9</b>
<b>3.1</b>	<b>General information.....</b>	<b>9</b>
<b>3.2</b>	<b>Precautions during handling and assembly.....</b>	<b>9</b>
<b>3.3</b>	<b>Precautions against risk of Electric Shock.....</b>	<b>10</b>
<b>3.4</b>	<b>Precautions against hot components.....</b>	<b>11</b>
<b>4</b>	<b>PRODUCT FEATURES.....</b>	<b>12</b>
<b>4.1</b>	<b>Description.....</b>	<b>12</b>
<b>4.2</b>	<b>Driver models.....</b>	<b>13</b>
4.2.1	Order codes.....	14
4.2.2	Model code.....	16
4.2.3	Accessories.....	17
<b>4.3</b>	<b>Ratings.....</b>	<b>18</b>
<b>4.4</b>	<b>Thermal dissipation.....</b>	<b>19</b>
<b>4.5</b>	<b>Ambient specifications.....</b>	<b>21</b>
<b>4.6</b>	<b>Electromagnetic compatibility (EMC).....</b>	<b>21</b>
<b>4.7</b>	<b>Physical specifications.....</b>	<b>22</b>
4.7.1	Weight.....	22
4.7.2	Size of COSMOS Type 315X / 325X.....	22
4.7.3	Size of COSMOS Type 3500/1 (first series).....	23
4.7.4	Size of COSMOS Type 3500/1 (second series).....	24
4.7.5	Size of COSMOS Type 3502.....	25
<b>5</b>	<b>INSTALLATION.....</b>	<b>26</b>
<b>5.1</b>	<b>Positioning and installation.....</b>	<b>26</b>
5.1.1	COSMOS Type 315X/325X.....	26
5.1.2	COSMOS Type 3500/1 (first series).....	27
5.1.3	COSMOS Type 3500/1 (second series).....	28
5.1.4	COSMOS Type 3502.....	29
<b>5.2</b>	<b>Electrical installation.....</b>	<b>30</b>
5.2.1	Power installation.....	30
5.2.2	Signal installation.....	31
5.2.3	Earth wiring.....	32
<b>5.3</b>	<b>Connectors wiring.....</b>	<b>33</b>
5.3.1	Auxiliary power supply input (24VDC/J5).....	33
5.3.2	Main power supply input (LINE/J1).....	34
5.3.3	Motor output (MOTOR/J4).....	36
5.3.4	DC BUS power supply (DC BUS/J3).....	37
5.3.5	Dynamic brake output (BRAKE R/J2).....	38
5.3.6	Encoder 1 input (E1).....	39
5.3.6.1	COSMOS Type 3XXX (first series).....	39

5.3.6.2	COSMOS Type 3XXX (second series).....	40
5.3.7	Encoder input/output 2 (E2).....	42
5.3.7.1	Encoder input (except Type 3502).....	42
5.3.7.2	Encoder repeat output (only Type 3502).....	42
5.3.8	STO system I/O (STO).....	43
5.3.9	General I/O.....	44
5.3.10	Field Bus FlxIO/SERCOS III/Modbus TCP (F1, F2).....	45
5.3.10.1	FlxIO connection.....	45
5.3.10.2	SERCOS III/Modbus TCP connection.....	45
5.3.11	Field bus SERCOS II (FRX, FTX).....	46
5.3.12	Operator interface (HMI).....	46
5.3.13	USB (USB).....	46
<b>5.4</b>	<b>Wiring diagram.....</b>	<b>47</b>
<b>5.5</b>	<b>Choice of the wires and fuses.....</b>	<b>48</b>
5.5.1	Protection for use exclusively in compliance with EN 61800-5-1.....	48
5.5.2	Protection for UL applications according to UL 61800-5-1 and CSA C22.2 No.274.....	49
<b>5.6</b>	<b>Installation criteria for UL certification.....</b>	<b>50</b>
<b>6</b>	<b>SAFETY INTEGRATED SYSTEM.....</b>	<b>51</b>
<b>6.1</b>	<b>Description.....</b>	<b>51</b>
<b>6.2</b>	<b>Operation.....</b>	<b>51</b>
6.2.1	Signals.....	51
6.2.2	Electrical specifications.....	51
6.2.3	System status.....	52
6.2.4	Intervention times.....	52
<b>7</b>	<b>OPERATOR INTERFACE.....</b>	<b>53</b>
<b>7.1</b>	<b>Function of the keys.....</b>	<b>53</b>
<b>7.2</b>	<b>Interaction.....</b>	<b>54</b>
7.2.1	Status message.....	54
7.2.1.1	Controller SERCOS III.....	54
7.2.1.2	Controller FlxIO.....	55
7.2.1.3	Controller SERCOS II.....	55
7.2.1.4	Analogue controller.....	55
7.2.1.5	Service controller.....	55
7.2.1.6	Modbus TCP/IP controller.....	55
7.2.2	Access level.....	55
7.2.3	Main menu.....	55
7.2.4	Measure menu.....	57
7.2.4.1	Models for brushless motor.....	57
7.2.4.2	Models for asynchronous motor.....	58
7.2.4.3	SERCOS II COSMOS.....	59
7.2.5	Status menu.....	60
7.2.5.1	Models for brushless motor.....	60
7.2.5.2	SERCOS II COSMOS.....	60
7.2.6	Control menu.....	61
7.2.6.1	Models for brushless motor.....	61
7.2.6.2	Models for asynchronous motor.....	64
7.2.6.3	SERCOS II COSMOS.....	66
7.2.7	Motor menu.....	68
7.2.7.1	Models for brushless motor and SERCOS II version.....	68
7.2.7.2	Models for asynchronous motor.....	70
7.2.8	SERCOS menu.....	71
7.2.8.1	SERCOS™ standard features (CEI IEC 1491).....	71
7.2.8.2	SERCOS interface configuration.....	71
7.2.8.3	SERCOS interface status.....	71
7.2.9	Analogue menu.....	71

7.2.9.1 Analog controller.....	72
7.2.9.2 Analogue controller configuration.....	72
7.2.9.3 Analogue controller status.....	73
7.2.10 Service menu.....	74
7.2.10.1 Models for brushless motor and for SERCOS II COSMOS.....	74
7.2.10.2 Models for asynchronous motor.....	74
7.2.11 External brake menu.....	75
7.2.11.1 Models for brushless motor and for SERCOS II COSMOS.....	75
7.2.11.2 Models for asynchronous motor.....	75
7.2.12 Input/output menu.....	77
7.2.13 Driver menu.....	80
7.2.13.1 Models for brushless motor.....	80
7.2.13.2 Models for asynchronous motor.....	81
7.2.13.3 SERCOS II COSMOS.....	81
7.2.14 Ethernet menu.....	82
7.2.15 Encoder menu.....	83
7.2.16 VISIO menu.....	84
7.2.16.1 Models for brushless motor.....	84
7.2.16.2 Models for asynchronous motor.....	84
7.2.16.3 SERCOS II COSMOS.....	84
<b>7.3 Reset to factory parameters.....</b>	<b>85</b>
<b>8 LEADS AND ADDRESS (FLXIO, SERCOS III AND MODBUS TCP).....</b>	<b>86</b>
<b>8.1 Address setting.....</b>	<b>86</b>
<b>8.2 LEDs "LINE" and "24VDC".....</b>	<b>87</b>
<b>8.3 LEDs "FLT" and "STS".....</b>	<b>87</b>
<b>8.4 LEDs I1, I2 and TO.....</b>	<b>87</b>
<b>8.5 LEDs A and L.....</b>	<b>87</b>
<b>8.6 LEDs FBS.....</b>	<b>88</b>
8.6.1 Field bus FlxIO.....	88
8.6.2 Field bus SERCOS III.....	88
<b>9 LEADS AND ADDRESS (SERCOS II MODEL).....</b>	<b>89</b>
<b>9.1 Address setting.....</b>	<b>89</b>
<b>9.2 P, E, O LEDs.....</b>	<b>89</b>
<b>9.3 FBS LEDs.....</b>	<b>89</b>
<b>9.4 FLT LED.....</b>	<b>89</b>
<b>9.5 D LED.....</b>	<b>89</b>
<b>10 ERROR CODES (FLXIO, SERCOS III AND MODBUS TCP).....</b>	<b>90</b>
<b>10.1 Internal errors.....</b>	<b>90</b>
<b>10.2 Control errors.....</b>	<b>91</b>
10.2.1 Models for brushless motor.....	91
10.2.2 Models for asynchronous motor.....	93
<b>10.3 Warnings.....</b>	<b>94</b>
10.3.1 Models for brushless motor.....	94
10.3.2 Models for asynchronous motor.....	94
<b>11 ERROR CODES (SERCOS II MODEL).....</b>	<b>95</b>
<b>11.1 Driver errors.....</b>	<b>95</b>

<b>11.2 SERCOS errors.....</b>	<b>97</b>
11.2.1 Error codes.....	97
11.2.2 Solution of communication problems.....	97
11.2.2.1 Errors from 21 to 25.....	98
11.2.2.2 Errors from 28 to 30.....	98
11.2.2.3 Error 32.....	98
11.2.2.4 Examples of errors.....	98
<b>12 FIRMWARE UPDATE.....</b>	<b>100</b>
12.1 Update on PC via USB connection.....	100
<b>13 MAINTENANCE.....</b>	<b>105</b>
13.1 Replacement of fan blower.....	105
13.1.1 COSMOS Type 315X/325X.....	105
13.1.2 COSMOS Type 350X.....	106
13.2 Replacement of dynamic brake resistor.....	106
13.2.1 COSMOS Type 325X.....	106
<b>14 APPENDICES.....</b>	<b>107</b>
14.1 List of settable motors.....	107

## 1 PREFACE

This manual is intended to provide the information necessary for the installation, use and maintenance of the COSMOS 315X/325X/350X series servo drives.

The instructions contained in this manual are intended for the following professionals:

<b>User</b>	User is a person, a company or an institution that buys the equipment and uses it for the purposes it was designed for.
<b>User/operator</b>	User or operator is a person authorized by the user to operate on the equipment.
<b>Specialized personnel</b>	It refers to all persons with specific competence, able to recognize and avoid the dangers deriving from the use of the equipment.

The present instructions must be made available to all the above individuals.





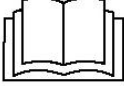

## 2 GENERAL WARNINGS

These assembly instructions are an integral part of the equipment, and must be kept for future reference until decommissioning.

The user should be informed that the present instructions reflect the state of the art at the moment when the equipment was sold; they will remain fully acceptable despite subsequent upgrades based on new experiences.

	<p><b>DO NOT USE THE EQUIPMENT, NOR MAKE ANY INTERVENTION BEFORE INTEGRALLY READING AND UNDERSTANDING THIS MANUAL.</b></p>
<p><b>IN PARTICULAR, ADOPT ALL SAFETY PRECAUTIONS AND PRESCRIPTIONS INDICATED IN THIS MANUAL.</b></p>	
<p><b>THE EQUIPMENT CANNOT BE USED FOR PURPOSES DIFFERENT THAN THE ONES DESCRIBED IN THIS MANUAL; SMITEC S.p.A. SHALL NOT BE HELD RESPONSIBLE FOR ANY DAMAGES, INCONVENIENCES OR ACCIDENTS DUE TO THE NON-COMPLIANCE WITH THESE PRESCRIPTIONS.</b></p>	

In order to make the manual consultation easier, the following symbols have been adopted:

	<p>Indication of "PROHIBITED ACTION".</p>
	<p>The symbol "DANGER" is used when the non-respect of the prescriptions or the tampering of organs can cause serious harm to people or things.</p>
	<p>The indication "DANGER FROM HOT SURFACES" is used when the non-respect of the prescriptions can cause serious damage to people or things.</p>
	<p>The indication "DANGER FROM ELECTRIC SHOCK" is used when failure to comply with the prescriptions can cause serious harm to people.</p>
	<p>The symbol "USE OF INDIVIDUAL PROTECTIONS" means that protective gloves must be worn</p>
	<p>The indication "USE PPE" protective glasses.</p>
	<p>Indication of "INFORMATION OF PARTICULAR RELEVANCE".</p>



The safety prescriptions aim at establishing a series of behaviours and obligations to be complied with, while performing the activities described later on in this manual.

These prescriptions constitute the prescribed method of operating the device, in a way that is safe for personnel, equipments and environment.





### 3 Safety instructions

#### 3.1 General information

	<p>Do not install or use the equipment before integrally reading and understanding this manual. In case of difficulties of interpretation, contact SMITEC technical service.</p>
	<p>It is absolutely forbidden to use the equipment for different purposes than the ones described in this manual. The technical data and the drawings in this manual might have been modified later; always refer to the latest version. All upgrades can be requested to SMITEC S.p.A. directly.</p>
	<p>Make sure that the personnel is qualified and adequately informed about the risks he may run and how to avoid them.</p>
	<p>The COSMOS 315X / 325X / 350X series servo drives is authorized can be used only after the classification of the machine operating area and after checking the safety levels, which must correspond to the assembly safety levels.</p>

#### 3.2 Precautions during handling and assembly

	<p>Use adequate tools during the assembly, in order to avoid crushing or abrasions.</p>
	<p>Metal components and sharp surfaces may cause cuts and tears. In case of contact, be very careful and wear the personal protection equipment.</p>

### 3.3 Precautions against risk of Electric Shock

	<p>The high voltage of some accessories and components in the driver might cause electrocution, if the user came into contact with them. The connectors with a dangerous voltage are: MOTOR/J4, BRAKE R/J2, DC BUS/J3, LINE/J1.</p>
	<p>There are some condensers inside the driver which maintain a dangerous voltage for at least 6 minutes after switching them off. Before starting any operation, make sure that the driver has been switched off at least 6 minutes earlier and that the motor is still.</p>
	<p>Avoid any metal components (screws, electrical cables...) fall into the driver during the installation, because they might cause short-circuits.</p>
	<p>The driver is an electric generator. The running speed becomes electric potential. High voltage is already generated at 300 rpm.</p>
	<p>During installation and maintenance, disconnect the device from the mains power supply. Risk of Electric Shock.</p>
	<p>Some components (such as the aluminium heat sink) are made of conductive materials. They must be safely connected to the protective conductor (PE/Ground) by using the specific terminal strips, in order to avoid Electric Shock.</p>
	<p>Never use the device if it is partially or totally disassembled. Risk of Electric Shock and/or damages to people and properties.</p>

### 3.4 Precautions against hot components

#### **WARNING**



The parts of the apparatus can reach an extremely high temperature in operating mode or post-operation; take particular care not to touch the parts of the equipment in these cases, or use special protections and precautions during handling: Hot Surface, Risk of Burn.

#### **AVERTISSEMENT**



Les pièces de l'appareil peuvent atteindre une température extrêmement élevée en mode de fonctionnement ou post-opération; veuillez particulièrement à ne pas toucher les pièces de l'équipement dans ces cas, ou utilisez des protections et des précautions spéciales lors de la manipulation: SURFACE CHAUDE, RISQUE DE BRÛLURE.

## 4 PRODUCT FEATURES

### 4.1 Description

The series of drivers COSMOS-3000 has been designed for motors with sinusoidal electromotive force and three-phase asynchronous motors.

The core of the power section is an intelligent IGBT module (IPM), featuring the necessary protections that guarantee an extreme reliability and efficiency, besides reducing the external components.

The control logic is implemented by a 32-bit micro-controller, equipped with a set of instructions optimized for speed and specialized in controlling precision motors.

Thanks to their design features, the drivers can be considered as of digital type, because they are completely controlled by the micro-controller. As a consequence, the drivers COSMOS-3000 are very flexible appliances which can be reset through a software and are open to all improvements offered by the new technologies in the future.

The driver parameters setting and the status notification are controlled by a field bus and/or, depending on the model, by a series of LEDs and by a special removable keyboard called VISIO 3000.

Last, but not least, the mechanical compactness makes of the COSMOS-3000 strong appliances which can be easily integrated with the fixing systems of the machine electrical panels.

## 4.2 Driver models

The series of drivers COSMOS 3000 includes appliances with different powers, different field buses and other different features; potentially, it is possible to create the most appropriate model for your needs.

<b>TYPE</b>	*	**	*	-	*	*
<i>Series</i>						
<b>3</b> = 3000						
<i>Peak current</i>						
<b>01</b> = 14Apk – 0,75kW						
<b>02</b> = 2 x 12Apk – 0,37kW						
<b>15</b> = 15Apk – 2.2kW						
<b>25</b> = 25Apk – 5.5kW						
<b>50</b> = 50Apk – 7.5kW						
<i>HW Version</i>						
<i>Sequential number, depending on the other figures</i>						
<i>Communication</i>						
<b>C</b> = EtherCAT						
<b>D</b> = Sercos II						
<b>E</b> = Ethernet						
<b>F</b> = FxIO						
<b>N</b> = None						
<b>R</b> = RS485						
<b>S</b> = Sercos III						
<b>T</b> = Flextron						
<i>Type of motor controlled</i>						
<b>A</b> = Asynchronous						
<b>B</b> = Brushless						
<b>U</b> = Brushless + Asynchronous						

#### 4.2.1 Order codes

Up to date, we defined some standard configurations of driver, with its order code and type number (4 figures + 2 letters, indicating the series, the maximum current, the release, the fieldbus and the usable motors). These data are indicated on the driver label.

##### COSMOS 3000 – first series:

<b>Order code</b>	<b>COSMOS Type</b>	<b>Field Bus</b>	<b>Motor type</b>	<b>Encoder type</b>
KZ010235	3250SB	SERCOS III	Permanent magnet brushless motor	Incremental encoder with differential line-driver outputs - 5V
KZ010271	3150FA	FlxIO	Three-phase asynchronous motor	Incremental encoder with single-ended HTL outputs - 24V
KZ010279	3500SB	SERCOS III	Permanent magnet brushless motor	Incremental encoder with differential line-driver outputs - 5V
KZ010321	3151SA	SERCOS III	Three-phase asynchronous motor	Incremental encoder with differential line-driver outputs - 5V
KZ010338	3250SA	SERCOS III	Three-phase asynchronous motor	Incremental encoder with differential line-driver outputs - 5V
KZ010339	3500SA	SERCOS III	Three-phase asynchronous motor	Incremental encoder with differential line-driver outputs - 5V
KZ010342	3251FA	FlxIO	Three-phase asynchronous motor	Incremental encoder with differential line-driver outputs - 5V
KZ010344	3501FA	FlxIO	Three-phase asynchronous motor	Incremental encoder with differential line-driver outputs - 5V
KZ010345	3152FA	FlxIO	Three-phase asynchronous motor	Incremental encoder with differential line-driver outputs - 5V
KZ010346	3151SB	SERCOS III	Permanent magnet brushless motor	Incremental encoder with differential line-driver outputs - 5V
KZ010347	3152FB	FlxIO	Permanent magnet brushless motor	Incremental encoder with differential line-driver outputs - 5V

COSMOS 3000 - second series:

Order code	COSMOS Type	Field Bus	Motor type	Encoder type
KZ010348	3251FB	FlxIO	Permanent magnet brushless motor	Incremental encoder with differential line-driver outputs – 5V (HD)
KZ010349	3501FB	FlxIO	Permanent magnet brushless motor	Incremental encoder with differential line-driver outputs - 5V (HD)
KZ010425	3250SB	SERCOS III	Permanent magnet brushless motor	Incremental encoder with differential line-driver outputs - 5V (HD)
KZ010430	3500SB	SERCOS III	Permanent magnet brushless motor	Incremental encoder with differential line-driver outputs - 5V (HD). It differs from KZ010469 only for the small encoder connector
KZ010433	3502DB	SERCOS II	Permanent magnet brushless motor	Incremental encoder with differential line-driver outputs - 5V (HD)
KZ010460	3150FA	FlxIO	Asynchronous phase motor	three- None or incremental encoder with single-ended HTL outputs - 24V (HD)
KZ010461	3151SA	SERCOS III	Asynchronous phase motor	three- None or incremental encoder with differential line-driver outputs - 5V (HD)
KZ010462	3152FA	FlxIO	Asynchronous phase motor	three- None or incremental encoder with differential line-driver outputs - 5V (HD)
KZ010463	3151SB	SERCOS III	Permanent magnet brushless motor	None or incremental encoder with differential line-driver outputs - 5V (HD)
KZ010464	3152FB	FlxIO	Permanent magnet brushless motor	Incremental encoder with differential line-driver outputs - 5V (HD)
KZ010465	3250SA	SERCOS III	Asynchronous phase motor	three- None or incremental encoder with differential line-driver outputs - 5V (HD)
KZ010466	3500SA	SERCOS III	Asynchronous phase motor	three- None or incremental encoder with differential line-driver outputs - 5V (HD)
KZ010467	3251FA	FlxIO	Asynchronous phase motor	three- None or incremental encoder with differential line-driver outputs - 5V (HD)
KZ010468	3501FA	FlxIO	Asynchronous phase motor	three- None or incremental encoder with differential line-driver outputs - 5V (HD)
KZ010469	3500SB	SERCOS III	Permanent magnet brushless motor	Incremental encoder with differential line-driver outputs - 5V (HD)
KZ010595	3250SB	SERCOS III	Permanent magnet brushless motor	Incremental encoder with differential line-driver outputs - 5V (HD)

Order code	COSMOS Type	Field Bus	Motor type	Encoder type
KZ010718	3501FA	FlxIO	Asynchronous three-phase motor	None or incremental encoder with differential line-driver outputs - 5V (HD). It differs from KZ010468 in that it does not have the integrated DCBUS capacitor charging system; an external connection of a resistor is required to charge the capacitors.



#### 4.2.2 Model code

The specific features of each driver COSMOS 3000 are defined by an alpha-numeric code printed on the device label, near the MODEL code. Here is the coding table.

<b>MODEL</b>	*	*	*	*	*	.	*	*	*	*	*	.	*	*	*	*	*
<i>Auxiliary power</i>																	
<b>1</b> = 24Vdc																	
<i>Main power</i>																	
<b>1</b> = 230÷480Vac 3PH																	
<i>Maximum output current – Asynchronous motor power</i>																	
<b>1</b> = 15Apk – 2.2kW																	
<b>2</b> = 25Apk – 5.5kW																	
<b>3</b> = 50Apk – 7.5kW																	
<i>Safe Torque Off (STO) system</i>																	
<b>0</b> = Absent																	
<b>1</b> = Present																	
<i>Dynamic brake</i>																	
<b>0</b> = Absent																	
<b>1</b> = Present																	
<i>Brake resistor</i>																	
<b>0</b> = Absent																	
<b>1</b> = 2,5kJ																	
<b>2</b> = 5,0kJ																	
<b>3</b> = 4,0kJ																	
<b>4</b> = 0,8kJ																	
<i>Encoder</i>																	
<b>0</b> = Absent																	
<b>1</b> = Incremental 5V diff. phases and HALL TTL + Hiperface																	
<b>2</b> = Hiperface																	
<b>3</b> = Incremental 5V diff. phases and HALL TTL																	
<b>4</b> = Incremental HTL 24V																	
<b>5</b> = Incremental 5V diff. phases and HALL TTL + Out																	
<b>6</b> = Incremental 5V diff. phases and HALL TTL/diff.																	
<i>Forced ventilation</i>																	
<b>0</b> = Absent																	
<b>1</b> = 1x31,5CFM																	
<b>2</b> = 2x31,5CFM																	
<b>3</b> = 2x10.8CFM																	
<i>Field bus physical layer</i>																	
<b>0</b> = Absent																	
<b>1</b> = EIA-RS485																	
<b>2</b> = Ethernet																	
<b>3</b> = POF – Sercos II																	
<i>VISIO 3000 support</i>																	
* = Absent per Type 3150																	
* = Present per Type 3250/3500																	
<b>0</b> = Absent																	
<b>1</b> = Present																	
<i>I/O Configuration</i>																	
* = Absent																	
<b>0</b> = Absent																	
<b>1</b> = Type 1																	
<b>2</b> = Type 2																	
<i>Reserved</i>																	
<i>Reserved</i>																	
<i>Reserved</i>																	
<i>Reserved</i>																	

### 4.2.3 Accessories

Depending on the model, the COSMOS 3000 drivers are supplied with a series of connectors for power, I/O and STO connections. The same connectors can be ordered separately, as well as other accessories not supplied with the driver. Here is a list of the order codes.

Item	Order code
VISIO 3000	KZ010262
Connector 24VDC / J5 *	KF101054
Connector LINE / J1 *	KF101042
Connector MOTOR / J4 *	KF101045
Connector DC BUS / J3 *	KF101044
Connector BRAKE R / J2 *	KF101043
Connector STO (except model 3502-DB) *	KF101051
Connector I/O (model 3502-DB) *	KF101048
Fan blower (models 315X/325X) *	KM021008
Brake resistor (model 325X, except order No KZ010595) *	KG020098
Brake resistor (only for model 325X order No KZ010595) *	KG020101
Cable USB 2.0 type A→mini B length: 3m	EC100213
Software Smittec Winmicro	KW050111

\* = included in the driver

### 4.3 Ratings

COSMOS Type	315X	325X	350X
Mains power input (40°C) <sup>1, 2, 3</sup>	230÷480Vac -15/+5% 3PH, 50/60Hz, 6.4Arms	230÷480Vac -15/+5% 3PH, 50/60Hz, 12Arms	230÷480Vac -15/+5% 3PH, 50/60Hz, 15.1Arms
Mains power input (55°C) <sup>1, 2, 3</sup>	230÷480Vac -15/+5% 3PH, 50/60Hz, 4.6Arms	230÷480Vac -15/+5% 3PH, 50/60Hz, 8.6Arms	230÷480Vac -15/+5% 3PH, 50/60Hz, 10.6Arms
Auxiliary power input <sup>4</sup>	24Vdc -15/+20%, 0.5A	24Vdc -15/+20%, 0.5A	24Vdc -15/+20%, 0.5A
STO power input	24Vdc -15/+20%, 10mA	24Vdc -15/+20%, 10mA	24Vdc -15/+20%, 10mA
I/O power input	24Vdc -15/+20%, 4A	24Vdc -15/+20%, 4A	24Vdc -15/+20%, 4A
Digital output			24Vdc, 0.7A each, 4A max total
Rated output (40°C) <sup>5</sup>	0÷480Vac, 0÷2kHz 8.5Arms @ sf=4KHz 7.0Arms @ sf=8KHz 6.0Arms @ sf=12KHz 4.5Arms @ sf=16KHz	0÷480Vac, 0÷2kHz 12.5Arms @ sf=4KHz 10.0Arms @ sf=8KHz 7.5Arms @ sf=12KHz 5.5Arms @ sf=16KHz	0÷480Vac, 0÷2kHz 18Arms @ sf=4KHz 18Arms @ sf=8KHz 15Arms @ sf=12KHz 11Arms @ sf=16KHz
Rated output (55°C) <sup>5</sup>	0÷480Vac, 0÷2kHz 5.95Arms @ sf=4KHz 4.88Arms @ sf=8KHz 4.2Arms @ sf=12KHz 3.15Arms @ sf=16KHz	0÷480Vac, 0÷2kHz 8.75Arms @ sf=4KHz 7.0Arms @ sf=8KHz 5.25Arms @ sf=12KHz 3.85Arms @ sf=16KHz	0÷480Vac, 0÷2kHz 12.6Arms @ sf=4KHz 12.6Arms @ sf=8KHz 10.45Arms @ sf=12KHz 7.7Arms @ sf=16KHz
Maximum output current	15A <sub>pk</sub>	25A <sub>pk</sub>	50A <sub>pk</sub>
Short-circuit current	5000Arms		

*Note 1: The COSMOS drivers must be equipped with a residual current circuit breaker type-B, able to detect alternating current leakage and direct current leakage (EN IEC 61800-3).*

*Note 2: Installation in networks with phase connected to earth (corner grounded) is forbidden.*

*Note 3: In case of installation of the driver in a IT power supply system, it is recommended to use an isolation transformer; make sure that the voltage drop at full load is lower than 2,5% of the rated voltage. In case of direct connection, always use RFI filters, with low leakage current. In case of earth fault, in order to avoid damaging the driver due to excess voltage between input and PE (Ground) terminal, it is recommended to timely remove the fault.*

*Note 4: The auxiliary power cables must be equipped with over current protection devices (IEC 60204-1 §9.1.3).*

*Note 5: The output currents are referred to the various switching frequencies (sf) of the drive*

#### 4.4 Thermal dissipation

The below graphics show the thermal dissipation, depending on the efficient output current. The four curves represent four switching frequencies of the driver, respectively 4kHz, 8kHz, 12kHz, 16kHz starting from the continuous line.

Please consider that:

- in case of variable output current, the average dissipated power must not be calculated by using the current average value, but by integrating the instant dissipated power.
- The dissipated power mostly depends on the driver switching frequency; in order to find intermediate values between those indicated in the graphics, interpolate linearly.
- The dissipated power on the braking resistors must be calculated separately.
- The dissipated power scarcely depends on the power factor of the load, but mostly on the absolute value of the output current; this is to say that the dissipated power is not strictly linked to the active power supplied to the load.

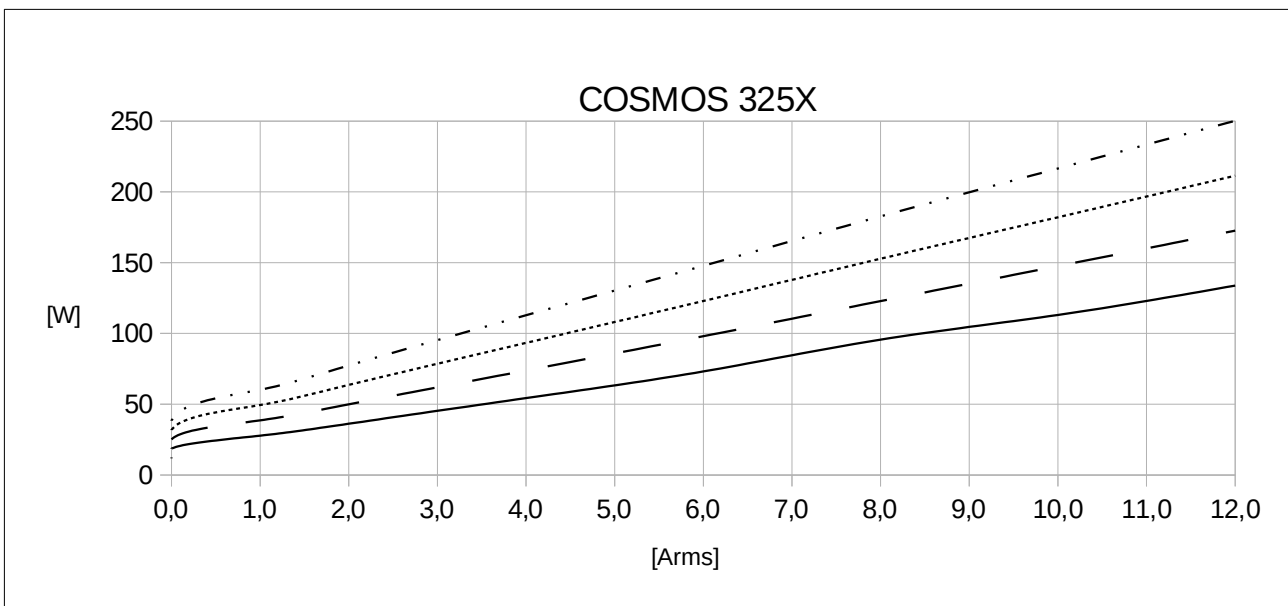
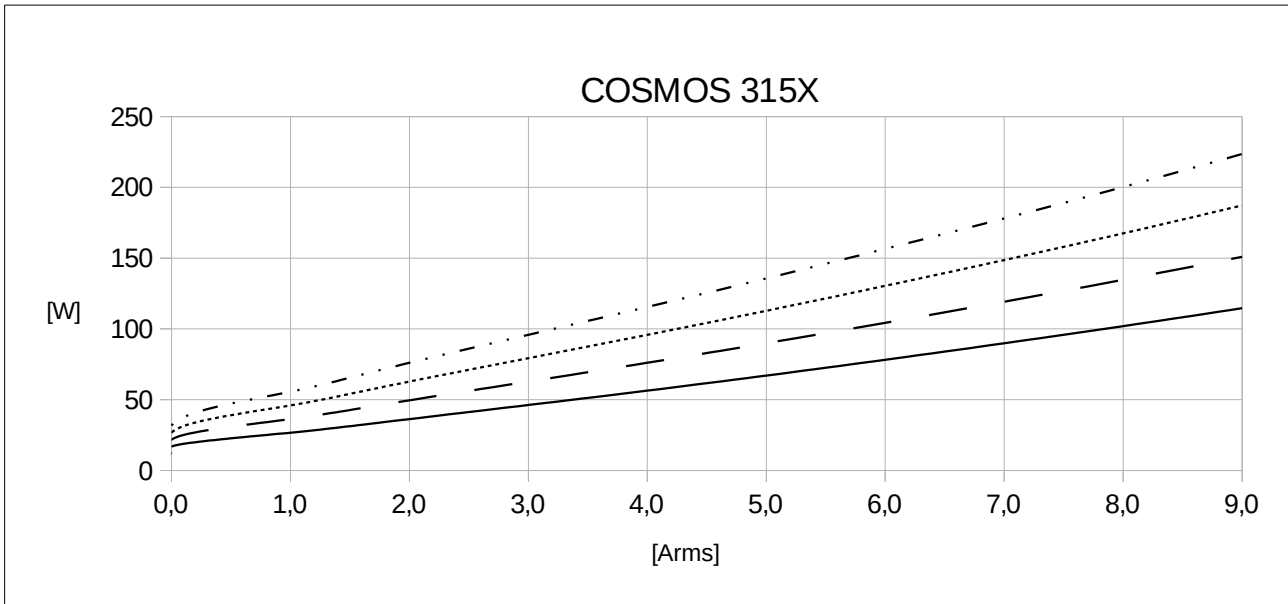

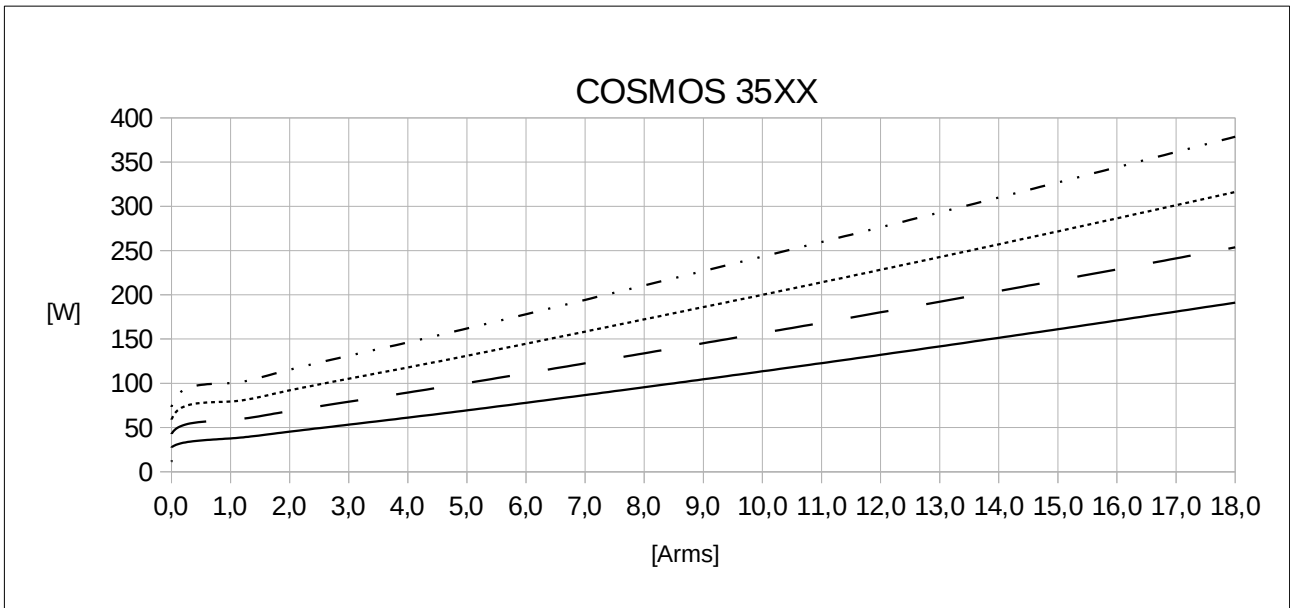

#### 4.5 Ambient specifications



COSMOS Type	315X	325X	350X
Operating temperature	0° ÷ 40°C without derating (full output current)		
	0° ÷ 55°C with derating (reduced output current; -2%/°C)		
Maximum surrounding air temperature (UL)	40°C without derating (full output current)		
	55°C with derating (reduced output current; -2%/°C)		
Installation environment	Use in Pollution degree 2 Environment		
Overvoltage category	III (3)		
Ambient humidity	5 ÷ 85% non condensing		
Operative altitude	0 ÷ 2000m		
Maximum operative altitude w/o current derating	1000m		
Maximum operative altitude with current derating (-10%/1000m)	2000m		
Transportation temperature	-25 ÷ +70°C		
Transportation humidity	5 ÷ 95%		
Transportation altitude	0 ÷ 4000m		
Stocking temperature	-25 ÷ +55°C		
Stocking humidity	5 ÷ 95%		
Stocking altitude	0 ÷ 3000m		
Protection degree <sup>1</sup>	IP20 – Open type (UL)		

*Note 1: the COSMOS drivers are designed for being installed in a closed electrical ambient, signalled by specific symbols, such as an electrical panel or a technical room, accessible to qualified personnel only. (EN IEC 61800-3).*

#### 4.6 Electromagnetic compatibility (EMC)

The drivers COSMOS 3000 comply with EN IEC 61800-3 standards; they can be used in the first environment, category C2 and in the second environment, category C3, on the following conditions:

- for the wiring between the driver and the motor, a shielded cable is necessary, connected to earth on the driver
- the driver is connected to the mains voltage, through the filter Schaffner FN3258H-30-3
- the start-up is performed by technical engineers, according to the instructions of this manual.

	<p>In order for an application integrating COSMOS 3000 drivers to comply with the electromagnetic compatibility standards, it will be necessary to select one or more net filters, depending on the number of drivers installed and on the other devices connected to the same line, as well as on the circulating currents.</p> <p>This product can cause interferences if it is installed in a domestic environment; in this case, it may be necessary to take countermeasures in order to reduce them.</p>
	<p>The USB port must be used exclusively for diagnostic purposes and for firmware updating. During the driver normal operation, the use of this port is not allowed.</p>

## 4.7 Physical specifications

### 4.7.1 Weight

COSMOS Type	315X	325X	350X (first series)	350X (second series)
Weight	1,8 kg	2,0 kg	3,9kg	3,6kg

### 4.7.2 Size of COSMOS Type 315X / 325X

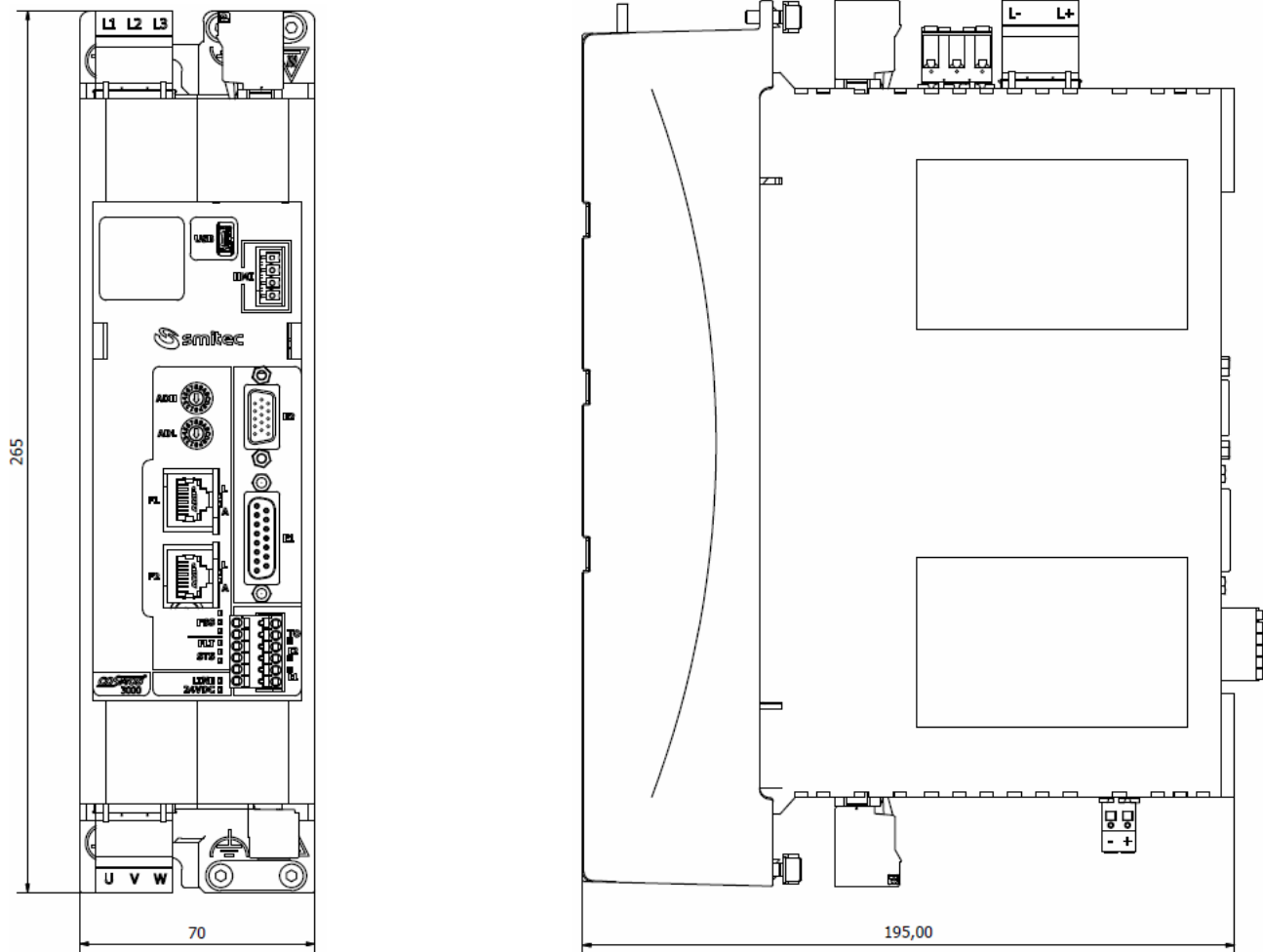

4.7.3 Size of COSMOS Type 3500/1 (first series)

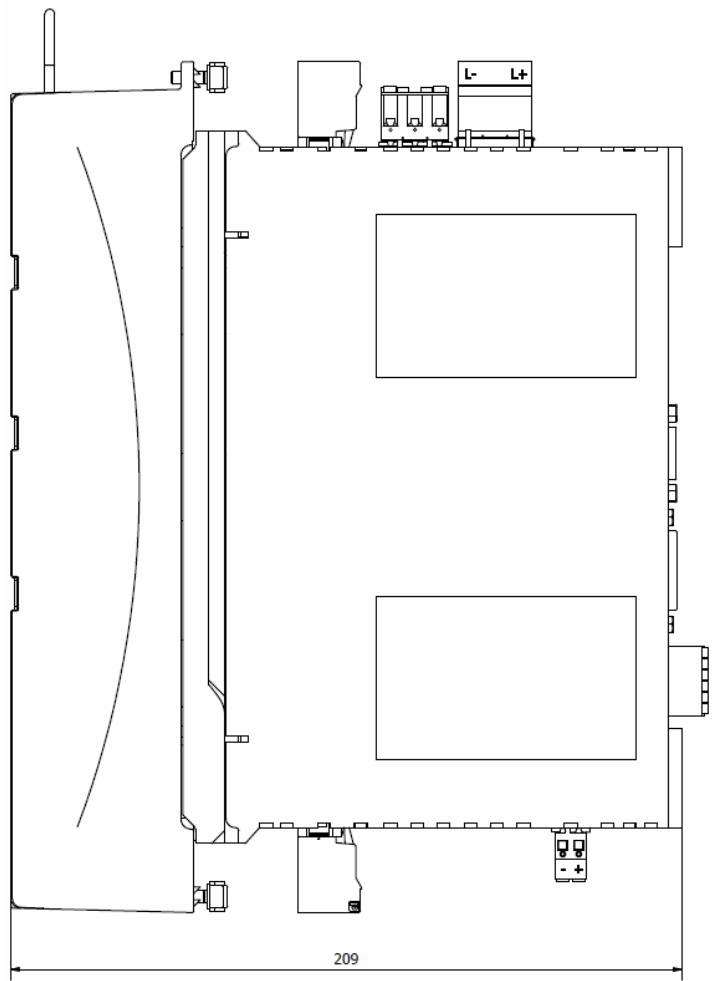
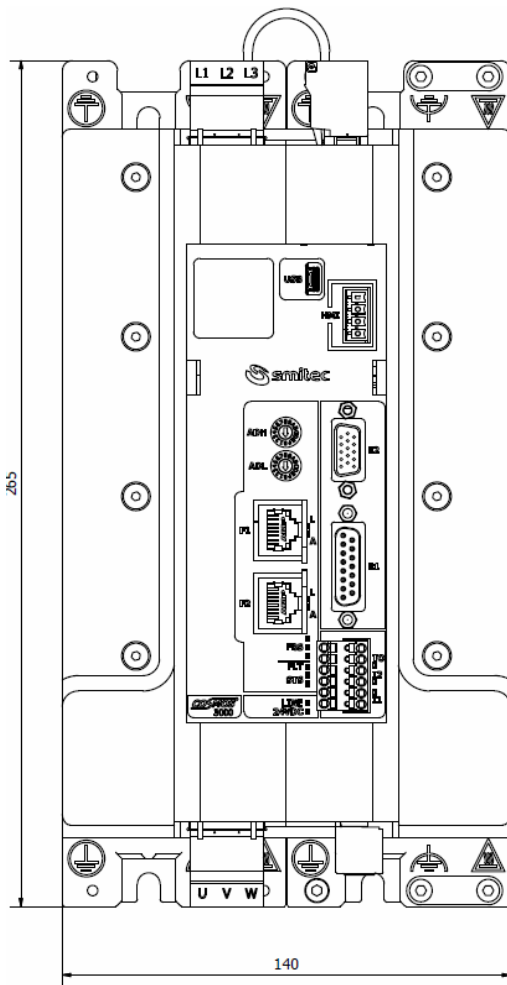



## 4.7.4 Size of COSMOS Type 3500/1 (second series)

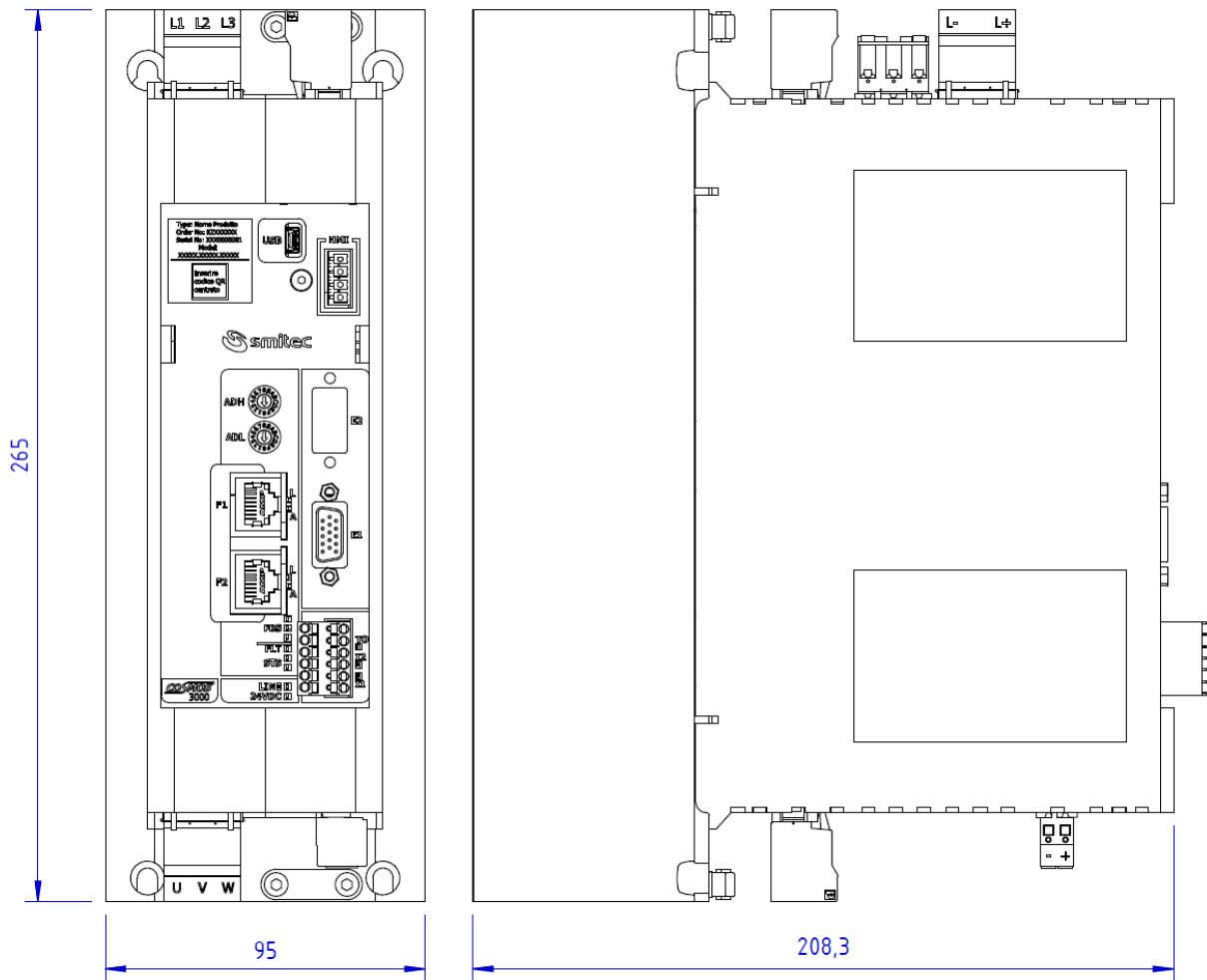

4.7.5 Size of COSMOS Type 3502

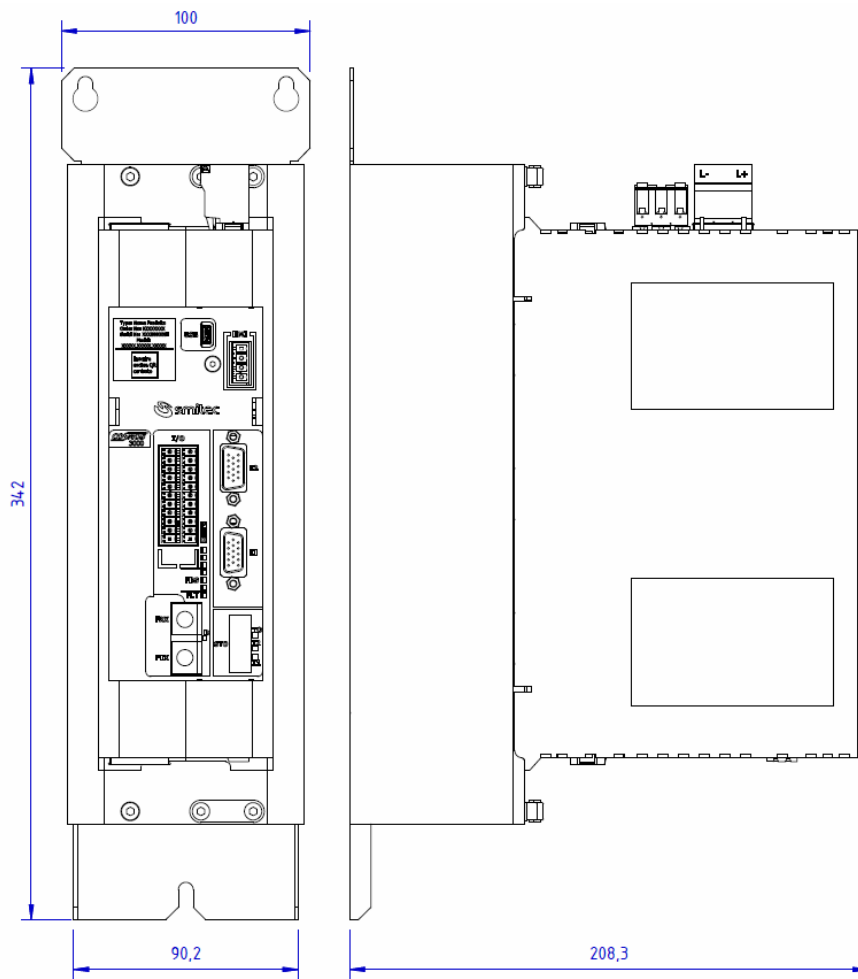

## 5 INSTALLATION

### 5.1 Positioning and installation

The drivers COSMOS 3000 can be installed close to an iron wall connected to earth. Install the driver in vertical position, with the fan side turned downwards, so that it can be cooled also by natural convection; a space of about 10 cm must be left above and below the driver.

In order to establish the electrical panel size, consider the thermal dissipation depending on the required output current, as indicated in chapter [3.4](#).



The drivers COSMOS 3000 are designed to be installed in closed electrical operating areas.

#### 5.1.1 COSMOS Type 315X/325X

Use the below template, in order to prepare the wall and fix the device with 2 screws M5, by duly tightening them.

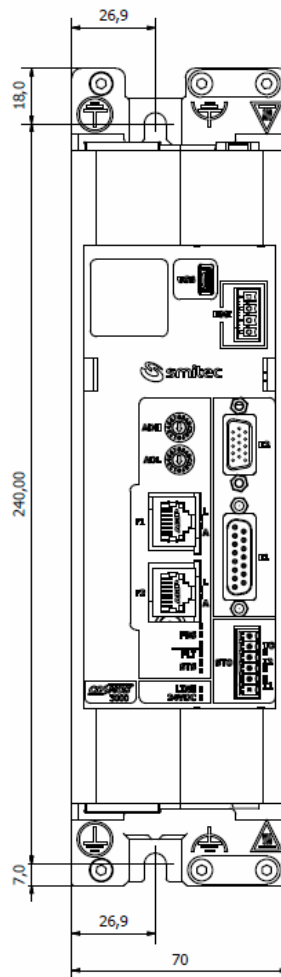

### 5.1.2 COSMOS Type 3500/1 (first series)

Use the below template, in order to prepare the wall and fix the device with 4 screws M5, by duly tightening them.

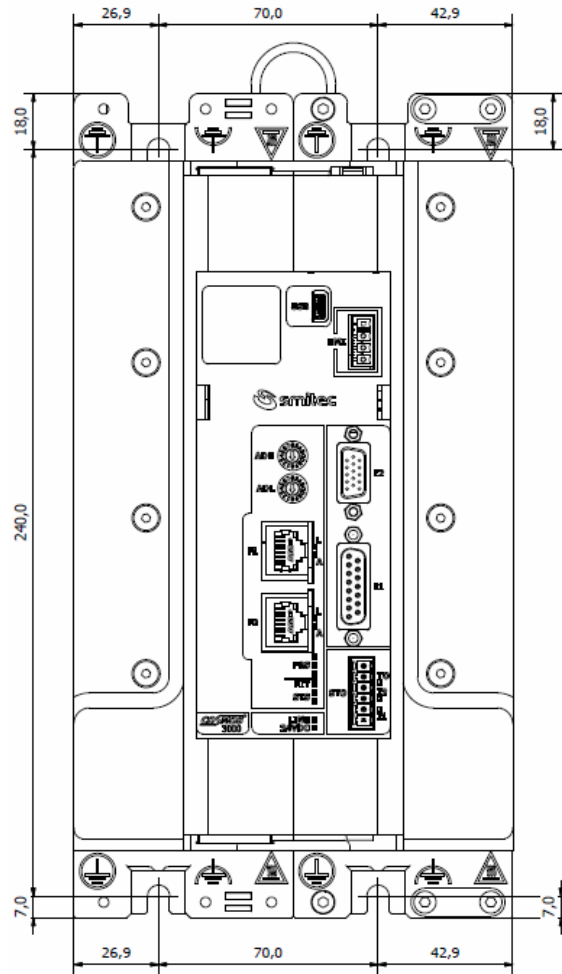





## 5.2 Electrical installation

For all models of COSMOS 3000, the connectors and their position as to the driver plastic body are identical. The electrical wiring is possible through removable connectors, in order to install and remove the drivers from the electrical panel more easily.

The following pictures represent the Type 3250, taken as an example.

### 5.2.1 Power installation



Due to the presence of high capacitance inside the driver, all power wiring must be connected or disconnected when the main power supply is absent for at least 6 minutes.

We consider as power wiring, the mains and auxiliary voltage, the motor output, the DC BUS voltage, the dynamic brake resistor.

The upper side houses the main power supply input (LINE J1), the DC BUS voltage (DC BUS J3) and the output for the dynamic brake resistor (BRAKE R J2).

The bottom side houses the auxiliary voltage input (24VDC J5) and the motor output (MOTOR J4).

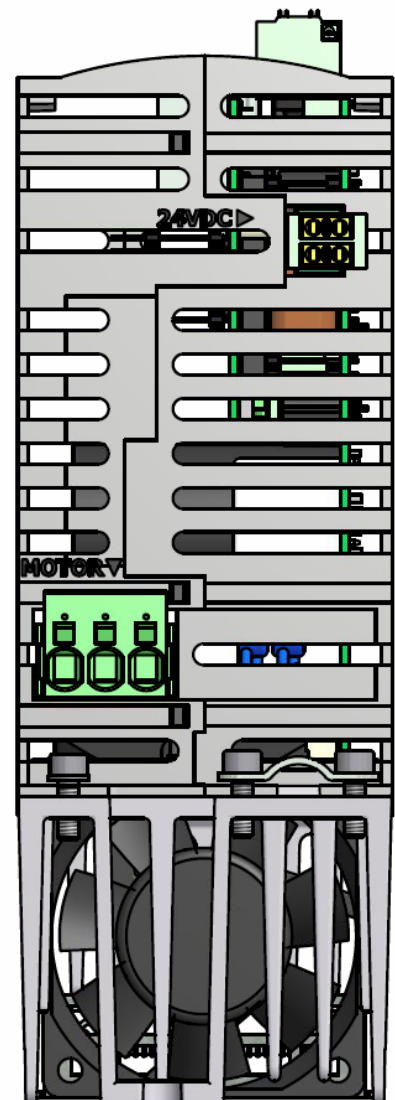
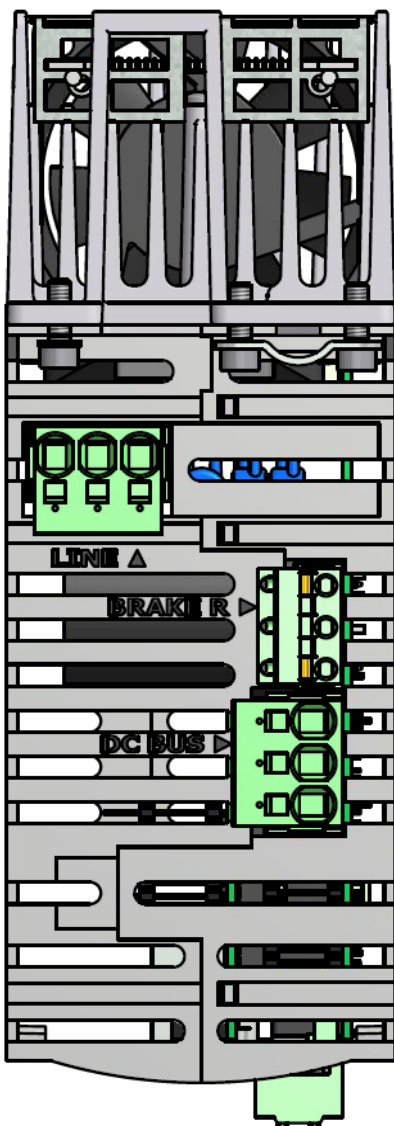

### 5.2.2 Signal installation

We consider as signal wiring the encoder inputs (E1, E2), the I/O modules of STO system (STO), the general I/O modules, the USB connection (USB), the connection for the VISIO 3000 (HMI), the connections for the field bus (F1, F2, FRX, FTX). They are all situated on the front side.



In order to avoid damaging the driver, all connections, except USB and HMI, must be connected/disconnected while the driver is off and the auxiliary voltage is absent.





## 5.2.3 Earth wiring

**CAUTION**

	For safety reasons the device must always operate with the PE (Ground) connection connected; risk of electrocution and/or device malfunctions.
---	--

**ATTENTION**

	Pour des raisons de sécurité, l'appareil doit toujours fonctionner avec la connexion PE (Ground) connectée. risque d'électrocution et / ou de dysfonctionnement de l'appareil.
---	--

Protective earth wiring must be made by means of the specific contact areas on the driver iron frame and are identified by the symbol of protection earth.

For shielded cables, the functional earth wiring must be made by means of the contact areas and by means of the cable-passes on the driver iron frame, identified by the symbol of functional earth.

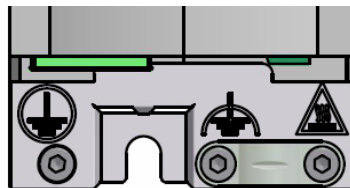

### 5.3 Connectors wiring

Please find here below the features of the allowed cables and connectors, as well as the legend of each connection of the drivers COSMOS 3000.

	The drivers COSMOS 3000 are electronic devices, sensitive to electrostatic charges. In order to avoid damages, it is necessary to adopt all preventive measures.
---	---

#### 5.3.1 Auxiliary power supply input (24VDC/J5 )

The auxiliary power supply is essential for the driver operation; in fact from the auxiliary power supply you can infer the necessary power for the inner electronic control .

The supplied connector is equipped with a double contact for each pole, in order to allow the connection of several drivers in parallel.

#### CAUTION

	It is necessary to strictly adhere to the polarity for the connection of the auxiliary voltage, in order to avoid irreversible damages to the driver.  It is very important to strictly adhere to the voltage limits indicated in the specifications, in order to avoid bad operation and/or irreversible damages.
---	--

#### ATTENTION

	Il est nécessaire de respecter scrupuleusement la polarité de connexion de la tension auxiliaire afin de ne pas risquer des pannes irrémédiables du variateur.  Il est nécessaire de respecter les limites de tension indiquées dans les spécifications afin de ne pas provoquer de dysfonctionnements et / ou de pannes irrémédiables du variateur.
---	--

Connector type: Phoenix Contact TVFKC 1,5/2-ST (1713839) * ** Order code: KF101054				
Features		Conductor cross section		
Connection in accordance with	EN-VDE	Solid min.	0,2 mm <sup>2</sup>	24 AWG
Rated voltage	250 V	Solid max.	1,5 mm <sup>2</sup>	16 AWG
Rated current	10 A	Stranded min.	0,2 mm <sup>2</sup>	24 AWG
		Stranded max.	1,5 mm <sup>2</sup>	16 AWG
Insulating material	PA	Stranded ferrule without plastic sleeve, min.	0,25 mm <sup>2</sup>	24 AWG
Flammability rating (Standard UL 94)	V0	Stranded ferrule without plastic sleeve max.	1,5 mm <sup>2</sup>	16 AWG
Stripping length	8 mm	Stranded ferrule with plastic sleeve min.	0,25 mm <sup>2</sup>	24 AWG
Screwdriver to be used in order to open the connections	0,6 x 3,5 mm	Stranded ferrule with plastic sleeve max.	1,5 mm <sup>2</sup>	16 AWG
*= Use 60/75 °C wires only (UL) **= Use Copper Conductors only (UL)				

Connector 24VDC	
Label	Signal
+	Auxiliary 24V
-	GND

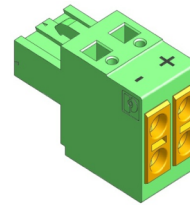

### 5.3.2 Main power supply input (LINE/J1)

The main power supply is used in order to provide the motor with power.

#### **CAUTION**

	It is necessary to strictly adhere to the voltage limits indicated in the specifications, in order to avoid irreversible damages to the driver.
---	---

#### **ATTENTION**

	Il est nécessaire de respecter les limites de tension indiquées dans les spécifications afin de ne pas provoquer de dysfonctionnements et / ou de pannes irréremédiables du variateur.
---	--

#### **CAUTION**

	Risk of Electric Shock; wait at least No. 360 seconds (6 minutes) after disconnecting power.
---	--

#### **ATTENTION**

	Risque de choc électrique; attendez au moins 360 secondes (6 minutes) après la mise hors tension.
---	---

	The connector is not provided with safety earth connection PE (Ground). It is necessary to connect the connector with earth, through the specific connection areas on the driver iron body.
---	--

<b>Connector type: Phoenix Contact SPC5/3-ST (1996029) * **</b> <b>Order code: KF101042</b>				
Features		Conductor cross section		
Connection in accordance with	EN-VDE	Solid min.	0,2 mm <sup>2</sup>	24 AWG
Rated voltage	1000 V	Solid max.	10 mm <sup>2</sup>	8 AWG
Rated current	41 A	Stranded min.	0,2 mm <sup>2</sup>	24 AWG
		Stranded max.	6 mm <sup>2</sup>	8 AWG
Insulating material	PA	Stranded ferrule without plastic sleeve, min.	0,25 mm <sup>2</sup>	24 AWG
Flammability rating (Standard UL 94)	V0	Stranded ferrule without plastic sleeve max.	6 mm <sup>2</sup>	8 AWG
Stripping length	15 mm	Stranded ferrule with plastic sleeve min.	0,25 mm <sup>2</sup>	24 AWG
Screwdriver to be used in order to open the connections	0,6 x 3,5 mm	Stranded ferrule with plastic sleeve max.	4 mm <sup>2</sup>	8 AWG
*= Use 60/75 °C wires only (UL) **= Use Copper Conductors only (UL)				

Connector LINE/ J1	
Label	Signal
L1	Line 1
L2	Line 2
L3	Line 2

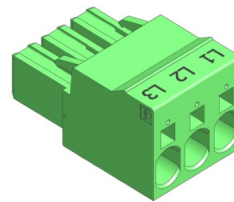

### 5.3.3 Motor output (MOTOR/J4)

The motor output is the power adjusted by the driver in order to start the connected motor.

	In order to avoid electro-magnetic interferences, it is necessary to use a shielded cable to be fixed by means of a cable-pass applied to the driver iron frame.
	The connector is not provided with the motor safety earth connection. It is necessary to connect the motor with earth, through the specific connection areas on the driver iron body.

<b>Connector type: Phoenix Contact SPC5/3-ST (1996029) * **</b> <b>Order code: KF101045</b>				
Features		Conductor cross section		
Connection in accordance with	EN-VDE	Solid min.	0,2 mm <sup>2</sup>	24 AWG
Rated voltage	1000 V	Solid max.	10 mm <sup>2</sup>	8 AWG
Rated current	41 A	Stranded min.	0,2 mm <sup>2</sup>	24 AWG
		Stranded max.	6 mm <sup>2</sup>	8 AWG
Insulating material	PA	Stranded ferrule without plastic sleeve, min.	0,25 mm <sup>2</sup>	24 AWG
Flammability rating (Standard UL 94)	V0	Stranded ferrule without plastic sleeve max.	6 mm <sup>2</sup>	8 AWG
Stripping length	15 mm	Stranded ferrule with plastic sleeve min.	0,25 mm <sup>2</sup>	24 AWG
Screwdriver to be used in order to open the connections	0,6 x 3,5 mm	Stranded ferrule with plastic sleeve max.	4 mm <sup>2</sup>	8 AWG

\*= Use 60/75 °C wires only (UL)  
 \*\*= Use Copper Conductors only (UL)

Connector MOTOR/ J4	
Label	Signal
U	Motor U phase
V	Motor V phase
W	Motor W phase

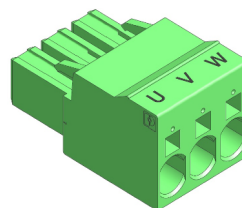

The section of the conductors must be sized according to the maximum current; in case of installation in the electrical panel of a machine, bear in mind that the EN 60204-1 standard does not allow the use of cables with a section of less than 0.75 mm<sup>2</sup> inside the enclosures and 1.0 mm<sup>2</sup> on the outside (0.75 mm<sup>2</sup> for multipolar cables ).

Therefore, it is recommended to use a multipolar cable with an appropriate section with shielding  $\geq 85\%$  with low parasitic capacitance specific for servomotors, with a length  $\leq 20m$ .

### 5.3.4 DC BUS power supply (DC BUS/J3)

The DC BUS power supply is a continuous voltage obtained by rectifying the voltage of the main power supply input; it is very useful for connecting in parallel several drivers, in order to recover the power produced by the braking motors and use it for the other motors. Furthermore, it is useful to distribute to different drivers the power dissipated by the dynamic brake.

#### **CAUTION**

	It is necessary to strictly adhere to the polarity of the DC BUS power supply, in order to avoid irreversible damages to the driver.
--	--

#### **ATTENTION**

	La polarité de la connexion de l'alimentation DC BUS doit être scrupuleusement respectée afin de ne pas risquer des pannes irréversibles de l'entraînement.
--	---

<b>Connector type: Phoenix Contact SPC5/3-ST (1996029) * **</b> <b>Order code: KF101044</b>				
Features		Conductor cross section		
Connection in accordance with	EN-VDE	Solid min.	0,2 mm <sup>2</sup>	24 AWG
Rated voltage	1000 V	Solid max.	10 mm <sup>2</sup>	8 AWG
Rated current	41 A	Stranded min.	0,2 mm <sup>2</sup>	24 AWG
		Stranded max.	6 mm <sup>2</sup>	8 AWG
Insulating material	PA	Stranded ferrule without plastic sleeve, min.	0,25 mm <sup>2</sup>	24 AWG
Flammability rating (Standard UL 94)	V0	Stranded ferrule without plastic sleeve max.	6 mm <sup>2</sup>	8 AWG
Stripping length	15 mm	Stranded ferrule with plastic sleeve min.	0,25 mm <sup>2</sup>	24 AWG
Screwdriver to be used in order to open the connections	0,6 x 3,5 mm	Stranded ferrule with plastic sleeve max.	4 mm <sup>2</sup>	8 AWG

\*= Use 60/75 °C wires only (UL)  
 \*\*= Use Copper Conductors only (UL)

Connector DC BUS/ J3	
Label	Signal
L+	+ DC BUS
L-	- DC BUS

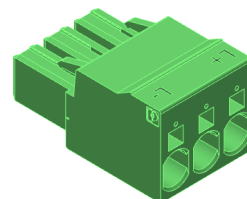

### 5.3.5 Dynamic brake output (BRAKE R/J2)

The dynamic brake output is arranged for the connection of a power resistor necessary for the dissipation of the power produced by the braking motors.



In the driver models equipped with dynamic brake it is essential that the internal resistance or an external one is connected to this output.

Connector type: Phoenix Contact GFKC 2,5/ 3-ST-7,62PA1,3BDR SO (1710972) * ** Order code: KF101043				
Features		Connector cross section		
Connection in accordance with	EN-VDE	Solid min.	0,2 mm <sup>2</sup>	24 AWG
Rated voltage	900 V	Solid max.	2,5 mm <sup>2</sup>	12 AWG
Rated current	12 A	Stranded min.	0,2 mm <sup>2</sup>	24 AWG
		Stranded max.	2,5 mm <sup>2</sup>	12 AWG
Insulating material	PA	Stranded ferrule without plastic sleeve, min.	0,25 mm <sup>2</sup>	24 AWG
Flammability rating (Standard UL 94)	V0	Stranded ferrule without plastic sleeve max.	2,5 mm <sup>2</sup>	12 AWG
Stripping length	8 mm	Stranded ferrule with plastic sleeve min.	0,25 mm <sup>2</sup>	24 AWG
Screwdriver to be used in order to open the connections	0,6 x 3,5 mm	Stranded ferrule with plastic sleeve max.	2,5 mm <sup>2</sup>	12 AWG

\*= Use 60/75 °C wires only (UL)  
\*\*= Use Copper Conductors only (UL)

Connector BRAKE R/ J2	
Label	Signal
<b>R</b>	Resistor
<b>R</b>	Resistor

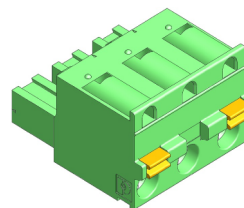

### 5.3.6 Encoder 1 input (E1)

The encoder 1 input, if present, is used in mutual exclusion with the encoder 2 (E2) input; it is useful for the driver or for the process controlling device, in order to know the real position of the motor or of a mechanical component and take corrective measures, if necessary. The encoder type depends on the driver model (see chapter [3.2.2](#)).

#### 5.3.6.1 COSMOS Type 3XXX (first series)

<b>Connector type: D-SUB SD15 M (not supplied)</b>			
<b>Order code: -----</b>			
<b>Features</b>		<b>Conductor cross section</b>	

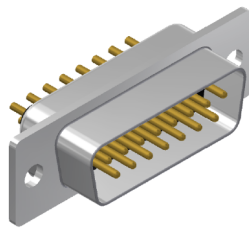

##### 5.3.6.1.1 Encoder connections 24V OC/HTL

Connector E1	
Label	Signal
1	Shield
2	Phase A
3	Phase B
4	
5	NTC
6	
7	
8	+24Vdc
9	GND
10	
11	
12	
13	NTC
14	
15	GND
SHELL	Shield

##### 5.3.6.1.2 Differential Encoder 5V connections

Connector E1	
Label	Signal
1	Shield
2	Phase A+
3	Phase B+
4	Zero +
5	NTC
6	HALL U
7	HALL V
8	+5Vdc
9	GND
10	Phase A-
11	Phase B-
12	Zero -
13	NTC
14	HALL W
15	GND
SHELL	Shield



## 5.3.6.2 COSMOS Type 3XXX (second series)

<b>Connector Type: D-SUB HD15 M (not supplied)</b>	
<b>Order code: -----</b>	
<b>Features</b>	<b>Connector cross section</b>

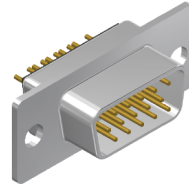

## 5.3.6.2.1 Encoder connections 24V OC/HTL

Connector E1	
Label	Signal
1	NTC
2	NTC
3	+24Vdc
4	GND
5	Shield
6	Phase A
7	Phase B
8	
9	
10	
11	
12	
13	
14	
15	
SHELL	Shield

## 5.3.6.2.2 Differential Encoder 5V connections (except Type 3502)

Connector E1	
Label	Signal
1	NTC
2	NTC
3	+5Vdc
4	GND
5	Shield
6	Phase A+
7	Phase B+
8	Hall U+ (#1)
9	Hall V+ (#1)
10	Hall W+ (#1)
11	Phase A-
12	Phase B-
13	Hall U- (#1)
14	Hall V- (#1)
15	Hall W- (#1)
SHELL	Shield

(#1) The circuitry in these models is designed for non balanced signals; therefore, it is possible to only connect positive poles (U+, V+, W+); should negative poles be available (U-, V-, W-), it is possible to connect them to the connector pins, in order to obtain a better immunity to interferences.

## 5.3.6.2.3 Differential Encoder 5V connections (only Type 3502)

Connector E1	
Label	Signal
1	NTC
2	NTC
3	+5Vdc
4	GND
5	Shield
6	Phase A+
7	Phase B+
8	Hall U+ (#1)
9	Hall V+ (#1)
10	Hall W+ (#1)
11	Phase A-
12	Phase B-
13	Signal Z+
14	Signal Z-
15	
SHELL	Shield

(#1) The circuitry in these models is designed for non balanced signals; therefore it is possible to only connect positive poles (U+, V+, W+).

### 5.3.7 Encoder input/output 2 (E2)

Depending on the models, the connector E2 can feature input signals for a second type of encoder or a repetition of the signals connected to connector E1 (see chapter [3.2.2](#)).

<b>Connector type: D-SUB HD15 F (not supplied)</b>			
<b>Order code: -----</b>			
<b>Features</b>		<b>Allowed conductor section</b>	

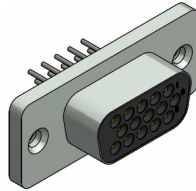

#### 5.3.7.1 Encoder input (except Type 3502)

Reserved.

#### 5.3.7.2 Encoder repeat output (only Type 3502)

This output is used for repeating some signals read by the encoder 1 input (E1); these signals are to be connected to acquisition devices, for control processes. Please note that the output signals on connector E2, as well as the input signals on connector E1 are not insulated from the 24VDC power supply.

Connector E2	
Signature	Signal
1	
2	Phase B+
3	Phase B-
4	Signal Z+
5	Signal Z-
6	
7	
8	
9	
10	
11	GND
12	Phase A+ *
13	Phase A- *
14	NTC
15	NTC
SHELL	Shield

\*: the output signals A + and A- are electrically exchanged with respect to the encoder input but reflect the reverse counting direction of the drive. This is due to the maintenance of compatibility with previous series drives.

### 5.3.8 STO system I/O (STO)

The I/O of this connector (if there is one in the model) are signals that are controlled by the integrated safety system; this system guarantees the absence of electrical power at the motor output. The connector we are supplying is equipped with a double throw for each pole, in order to allow the connection of several drivers in parallel.

#### **CAUTION**

	It is necessary to strictly adhere to the connection polarity of the mains voltage of the STO section, in order to avoid irreversible damages to the driver.
	It is necessary to strictly adhere to the voltage limits indicated in the specifications, in order to avoid irreversible damages to the driver.

#### **ATTENTION**

	Il est nécessaire de respecter scrupuleusement la polarité de connexion de la tension d'alimentation de la section STO afin d'éviter tout risque de défaillance irréversible du variateur.
	Il est nécessaire de respecter les limites de tension indiquées dans les spécifications afin de ne pas provoquer de dysfonctionnements et / ou de pannes irrémédiables du variateur.

<b>Connector type: Phoenix Contact TFMC1,5/6-ST-3,5 (1772650) * **</b> <b>Order code: KF101051</b>				
Features		Conductor cross section		
Connection in accordance with	EN-VDE	Solid min.	0,2 mm <sup>2</sup>	24 AWG
Rated voltage	160 V	Solid max.	1,5 mm <sup>2</sup>	16 AWG
Rated current	8 A	Stranded min.	0,2 mm <sup>2</sup>	24 AWG
		Stranded max.	1,5 mm <sup>2</sup>	16 AWG
Insulating material	PA	Stranded ferrule without plastic sleeve, min.	0,25 mm <sup>2</sup>	24 AWG
Flammability rating (Standard UL 94)	V0	Stranded ferrule without plastic sleeve max.	1,5 mm <sup>2</sup>	16 AWG
Stripping length	10 mm	Stranded ferrule with plastic sleeve min.	0,25 mm <sup>2</sup>	24 AWG
Screwdriver to be used in order to open the connections	0,6 x 3,5 mm	Stranded ferrule with plastic sleeve max.	0,75 mm <sup>2</sup>	16 AWG

\*= Use 60/75 °C wires only (UL)  
 \*\*= Use Copper Conductors only (UL)

Connector STO	
Label	Signal
GND	GND
FBK	Feedback contact
FBK	Feedback contact
EN2	Enable 2
EN1	Enable 1
24V	+ 24Vdc

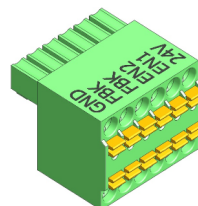

### 5.3.9 General I/O

The I/O of this connector (if there is one in the model) are designed for general purposes under the control of the master device of the field bus and/or they can be set on the driver through the operator interface.

#### **CAUTION**

	<p>It is necessary to strictly adhere to the connection polarity of the mains voltage of the I/O section, in order to avoid irretrievable damages to the driver.</p> <p>It is necessary to strictly adhere to the voltage limits indicated in the specifications, in order to avoid malfunction and/or irretrievable damages to the driver.</p>
--	---

#### **ATTENTION**

	<p>Il est nécessaire de respecter scrupuleusement la polarité de connexion de la tension d'alimentation de la section d' I/O afin de ne pas risquer des pannes irrémédiables du variateur.</p> <p>Il est nécessaire de respecter les limites de tension indiquées dans les spécifications afin de ne pas provoquer de dysfonctionnements et / ou de pannes irrémédiables du variateur.</p>
--	--

**Connector type: Phoenix Contact FMCD1,5/11-ST-3,5 (1738898) \* \*\***  
**Order code: KF101048**

Features		Conductor cross section		
Connection in compliance with	EN-VDE	Solid min.	0,2 mm <sup>2</sup>	24 AWG
Rated voltage	160 V	Solid max.	1,5 mm <sup>2</sup>	16 AWG
Rated current	8 A	Stranded min.	0,2 mm <sup>2</sup>	24 AWG
		Stranded max.	1,5 mm <sup>2</sup>	16 AWG
Insulating material	PA	Stranded ferrule without plastic sleeve min.	0,25 mm <sup>2</sup>	24 AWG
Flammability rating (UL 94)	V0	Stranded ferrule without plastic sleeve max.	1,5 mm <sup>2</sup>	16 AWG
Stripping length	10 mm	Stranded ferrule with plastic sleeve min.	0,25 mm <sup>2</sup>	24 AWG
Screwdriver to be used to open the connections	0,6 x 3,5 mm	Stranded ferrule with plastic sleeve max.	0,75 mm <sup>2</sup>	16 AWG

\*= Use 60/75 °C wires only (UL)

\*\*= Use Copper Conductors only (UL)

I/O connector			
Pin	Signal	Pin	Signal
1	IN1 V-	12	IN1 V+
2	AN GND	13	OUT C+
3	OUT V+	14	IN2 V-
4	IN2 V+	15	AN GND
5	I/O 8	16	I/O 7
6	I/O 6	17	I/O 5
7	I/O 4	18	I/O 3
8	I/O 2	19	I/O 1
9	I/O GND	20	I/O 24V
10	I/O GND	21	I/O 24V
11	I/O GND	22	I/O 24V

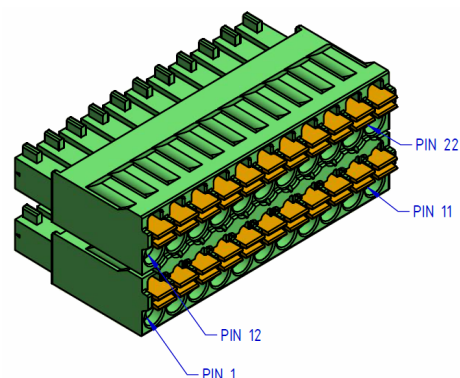

### 5.3.10 Field Bus FlxIO/SERCOS III/Modbus TCP (F1, F2)

The field bus connection allows the drivers communication with a control system.

<b>Connector type: SHIELDED PLUG RJ45 Cat. 5E (not supplied)</b>			
<b>Order code: -----</b>			
<b>Features</b>		<b>Conductor cross section</b>	

#### 5.3.10.1 FlxIO connection

	Refer to the FlxIO bus integration and FlxMod system DK400076 manual for the correct definition of the connection topology of the FlxIO bus.
--	--

The communication bus is based on physical layer EIA-RS485. Due to the automatic line termination system, it is important to strictly adhere to the series connection sequence of the devices. Connector F1 must be used for the bus connection (on the master side) whereas connector F2 must be used for the connection of next devices in the series.

Connector F1	
Pin	Signal
1	DATA +
2	DATA -
3	GND
4	
5	
6	
7	Termination loop
8	Termination loop
SHELL	Shield

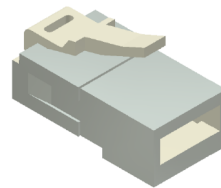

Connector F2	
Pin	Signal
1	DATA +
2	DATA -
3	GND
4	
5	
6	
7	Termination sense
8	Termination sense
SHELL	Shield

#### 5.3.10.2 SERCOS III/Modbus TCP connection

The communication buses are based on physical layer Ethernet 100Mbps.

Connector F1, F2	
Label	Signal
1	TX +
2	TX -
3	RX +
4	
5	
6	RX -
7	
8	
SHELL	Shield

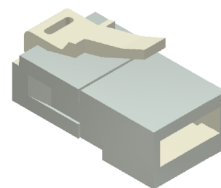

### 5.3.11 Field bus SERCOS II (FRX, FTX)

The field bus connection allows the drivers communication with a control system.

<b>Connector type: SMA for plastic optical fibre - 1mm (not supplied)</b>			
<b>Order code: -----</b>			
<b>Features</b>		<b>Conductor cross section</b>	

The communication bus is based on 660nm optical transmission on plastic fibre.

Connector FRX	
Colour	Signal
Dark grey	Reception

Connector FTX	
Colour	Signal
Light grey	Transmission



### 5.3.12 Operator interface (HMI)

This is a specific connection for the operator interface VISIO 3000.

### 5.3.13 USB (USB)

This connection is a standard USB port 2.0 for firmware updating and diagnostic purposes. The connector type installed in the driver is 5-pin USB Mini-B, very common in hand-held devices.



The USB port must be used exclusively for diagnostic purposes or for firmware updating. It is not allowed during the driver normal operation.

### 5.4 Wiring diagram

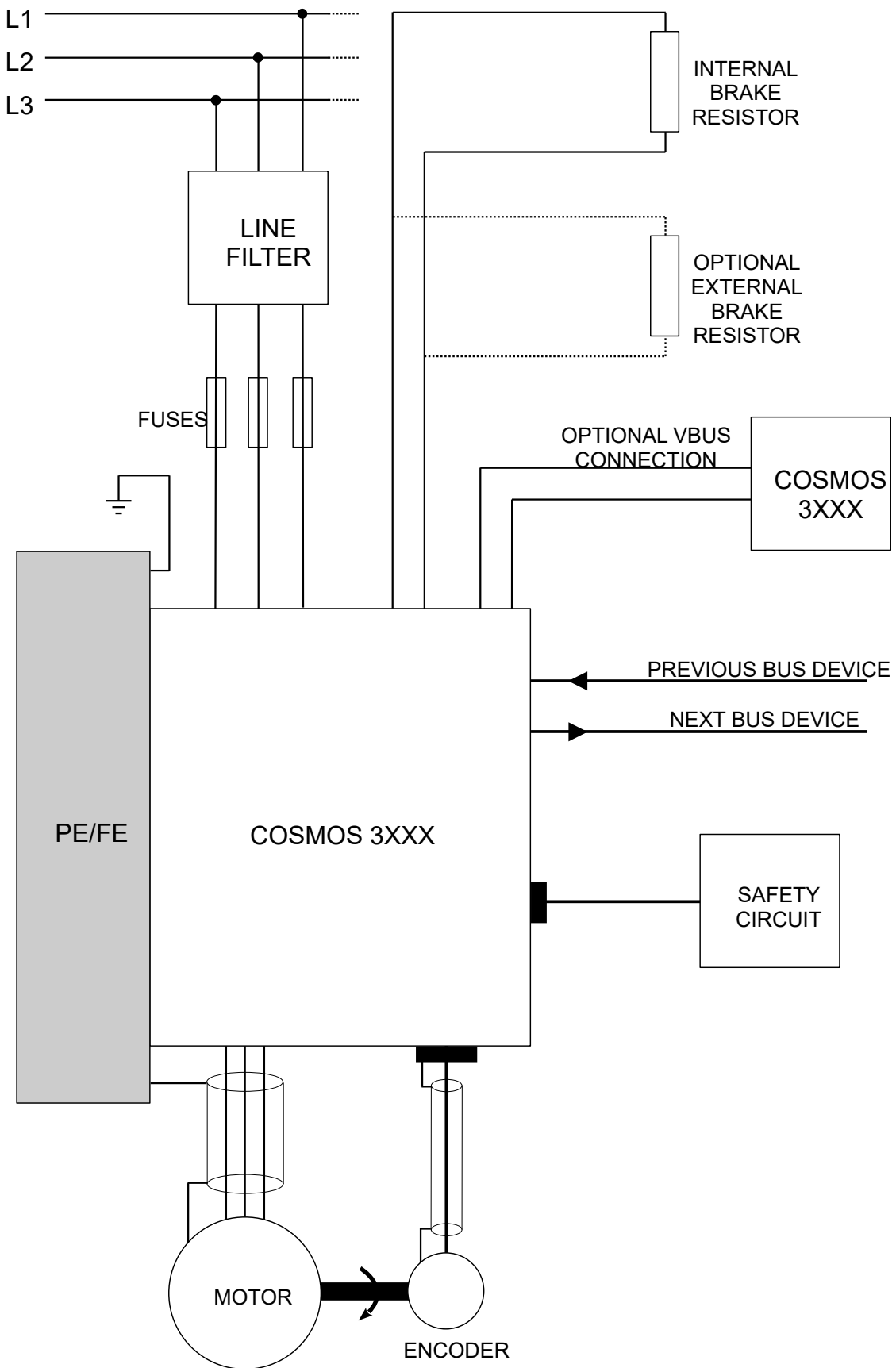



## 5.5 Choice of the wires and fuses

### 5.5.1 Protection for use exclusively in compliance with EN 61800-5-1

The below chart shows the size of the power supply cables and fuses; the values refer to ambient temperature equal to 40°C and to PVC insulated wires.

Input current [A]	Minimum section [mm <sup>2</sup> ]	Maximum fuse rating [A]
<b>Cable laying mode: category B1 (in accordance with EN 60204-1). gG fuses.</b>		
$I < 8.5$	1.5	10
$8.5 \leq I < 10.0$	2.5	16
$10.0 \leq I < 17.0$	4.0	20
$I \geq 17.0$	6.0	25
<b>Cable laying mode: category B2 (in accordance with EN 60204-1). gG fuses.</b>		
$I < 5.0$	1.0	6
$5.0 \leq I < 8.5$	1.5	10
$8.5 \leq I < 10.0$	2.5	12
$10.0 \leq I < 17.0$	4.0	20
$I \geq 17.0$	6.0	25

In order to allow protection of the device and power supply conductors (in compliance with IEC 60204-1), the use of fuses in series with both power supply lines is recommended. The protective conductor (PE/Ground) must never be sectioned.

The breaking capacity of the fuse used must be greater than the maximum short-circuit current expected at the point of installation; it must be limited to 5 kA max. at the servo drive input.

In the event that the servo drive is to be used for the construction of a machine, refer to the EN 60204-1 standard for more information on the dimensioning criteria.

	The use of conductors with a section below the recommended value could cause a risk of fire and damage to persons and property.
	The use of an unsuitable over current protection device could cause it to fail to intervene, with danger to people and things. Furthermore, spurious protection interventions may occur.

### 5.5.2 Protection for UL applications according to UL 61800-5-1 and CSA C22.2 No.274

The characteristics of the recommended fuses are summarized in the following tables, depending on the COSMOS servo drive model which they are used.



<b>COSMOS 315X-325X</b>	
Manufacturer	Mersen/Ferraz
Model	FR10GR69V25
Class	gR (IEC 60269-4)
Dimension	10x38 mm
Rated current	25 A
Working voltage	700 V AC

<b>COSMOS 350X</b>	
Manufacturer	Mersen/Ferraz
Model	FR14GR69V40
Class	gR (IEC 60269-4)
Dimension	14x51 mm
Rated current	40 A
Working voltage	700 V AC



Suitable For Use On A Circuit Capable Of Delivering Not More Than 5000 Arms Symmetrical Amperes, 480 Vac Maximum when protected by semiconductor fuses model FR10GR69V25 by Mersen for the COSMOS 315X-325X drives and by semiconductor fuses model FR14GR69V40 by Mersen for the COSMOS 350X drive.

## 5.6 Installation criteria for UL certification

	<p>Integral solid state short circuit protection does not provide branch circuit protection. Branch circuit protection must be provided in accordance with the Manufacturer Instructions, National Electrical Code and any additional local codes.</p>
	<p>The drive does not provide Motor Overload protection. External or remote Motor Overload protection shall be provided in the end-use applications.</p>
	<p>The drive is intended to be used with motors that must have integral thermal protection.                  The integral thermal protection signal shall be connected on the equipment, on terminal "E1, pins 1-2 for models 315X-XX, 325X-XX, 350X-XX.                  Signal was rated maximum 5Vdc, 5mA.</p>

## 6 Safety integrated system

### 6.1 Description

The drivers COSMOS 3000 are equipped with a circuit for the STO function (Safe Torque Off). This function, if enabled, allows the driver output to be disabled so that the driver cannot generate torque (or force, in case of linear motors). The motor will actually stop in a time that can vary according to the inertia or to the load mechanical features; if it were necessary to guarantee the stop of the mechanical device within a maximum time (example a load lifted by a pulley), it will be necessary to implement this function with additional systems.

Features:

- the intervention of the STO function totally excludes the driver possibility to control the motor
- there is no way to disable the safety function, either intentionally or unintentionally
- the STO system is equipped with two independent inputs; a break-down of one of the two channels does not interfere with the operation of the other channel
- the two inputs are powered by the same power supply, independent from any other power supplies of the driver
- the STO system was designed to tolerate 1 hardware break-down
- the level of safety integrity is SIL2 with PFH (Probability of random Failure per Hour)  $< 1 \times 10^{-9}$
- The STO mission time is 20 years
- The required ambient conditions, the use and maintenance are the same as those required by the driver.

In order to guarantee the required safety degree, it is necessary to adequately control the signals, for example by using a certified safety PLC.

### 6.2 Operation

#### 6.2.1 Signals

The below chart shows the wiring and meaning of the signals.

Signal	Description
24V	Positive power supply for the safety circuit section
GND	Mass of the power supply of the safety circuit section and reference for the inputs
EN1	Enable 1 signal, active at high logical level (24V = enabled, 0V = disabled)
EN2	Enable 2 signal, active at high logical level (24V = enabled, 0V = disabled)
FBK-FBK	Potential free contact; open, in case of safety system failure

#### 6.2.2 Electrical specifications

Mains voltage	24V -15% ÷ +20%, with a ripple with a peak value equal to 5% of the rated value (extreme values equal to respectively 19.2 and 30.0 V)
EN1 and EN2 inputs	Type 1 and type 3 in accordance with IEC61131-2 standards
EN1 and EN2 limits	$V_{IL}=5,0V$ max.; $V_{IH}= 15,0V$ min.
Admissible voltage EN1 e EN2	30V max.
Absorbed current EN1 e EN2	5.5 mA max. each
Admissible voltage FBK-FBK	30V max.
Admissible current FBK-FBK	500mA max.

### 6.2.3 System status

The below chart shows the safety circuits possible statuses.

24V	EN1	EN2	[SAFETY CIRCUIT]	I1	I2	TO	FBK-FBK	[TORQUE]
<16V	X	X	X	X	X	OFF	OPEN	DISABLED
>31V	X	X	X	X	X	OFF	OPEN	DISABLED
OK	OFF	OFF	OK	OFF	OFF	ON	CLOSE	DISABLED
OK	ON	OFF	OK	ON	OFF	ON	CLOSE	DISABLED
OK	OFF	ON	OK	OFF	ON	ON	CLOSE	DISABLED
OK	ON	ON	OK	ON	ON	ON	CLOSE	ENABLED
OK	X	X	FAULTY	X	X	OFF	OPEN	DISABLED

X = Not consistent



The driver can be enabled only with a correctly powered safety circuit, free from failures, with EN1 and EN2 inputs active.

### 6.2.4 Intervention times

The drivers COSMOS 3000 feature the following intervention times.

$T_{t(off)}$	Time that elapsed between the safety inputs disabling and the STO function intervention	< 100ms
$T_{fit(off)}$	Time that elapsed between the failure detection in the safety circuit and the STO function intervention	< 100ms
$T_{mot(off)}$	Time that elapsed between the STO function activation and the actual motor stop	Depending on the motor and on the load

## 7 Operator interface

The operator interface of the COSMOS 3000 (where present) is the VISIO 3000, consisting of an alphanumeric display with 2 rows of 8 characters each and 4 directional keys. The VISIO is installed on the front side of the driver and is connected to the HMI.



### 7.1 Function of the keys

◀	<p>Navigation: by pressing the left arrow, you go back to the upper level menu. If you are in the main menu, the device status will be displayed. By pressing this key again, the firmware version and the driver model will be displayed.</p> <p>Data modification: it shifts the tab on the figure on the left side of the displayed figure. If the tab is already on the figure on the extreme left, no shift occurs. It is possible to eliminate a modification, while it has not been confirmed yet, by pressing this key for 1 second.</p>
▶	<p>Navigation: by pressing the right arrow, you go to the lower level menu. The items accepting a lower value, that is to say a submenu, are indicated by "&gt;". The active entry is situated on the first row of the LCD.</p> <p>Data modification: by pressing this key for at least 1 second, you activate the mode to modify the selected parameter (hereinafter indicated by the symbol <math>\bar{\bar{A}}</math>). This mode is identified by the presence of the tab below the character situated at the extreme right: by pressing this key, you shift the tab on the figure on the right side of the displayed figure. If the tab is already on the figure on the extreme right, no shift occurs. In order to confirm the modification, press this key for at least 1 second.</p>
▲	<p>Navigation: By pressing the arrow "upwards", you go to the previous entry of the current menu. If you are at the first entry of the main menu, you go back to the driver status message.</p> <p>Data modification: it increases the figure on which the tab is positioned. If the figure reaches the maximum value, the LCD will try to increase the figure on the left, if it is not already at its maximum value.</p>
▼	<p>Navigation: by pressing the arrow "downwards", you go to the next entry of the current menu. The end of the list of the entries in the menu is displayed by a series of hyphens (-).</p> <p>Data modification: it decreases the figure on which the tab is positioned. If the figure reaches the minimum value, the LCD will try to decrease the figure on the left, if it is not already at its minimum value.</p>

## 7.2 Interaction

The menus displayed by the LCD are organized in a hierarchic way. From the status message, it is possible to enter the main menu by pressing  $\square$  or  $\square$ .

For the parameters, there is an access level classification: as a consequence, each datum can be matched to a protection level. In order to shift to the next level, you must enter a password, by using the special function.

### 7.2.1 Status message

As soon as you supply the auxiliary power or you press the navigation key  $\square$  in the main menu, a message will be displayed for 2 seconds: the first row of the message indicates the drive model, called ASI if the device controls an asynchronous motor, BRU if the device controls a brushless motor or simply 3502-DB if the device is a COSMOS SERCOS II. The second row displays the firmware version.

```
ASI 3150
VER 3.00
```

Then, the LCD will display the status message, where you can find information about the status of the field bus and of the driver.

The status message is automatically displayed also during the navigation in the menus, when an error condition occurs. In this case, by pressing any key you will go back to the entry previously displayed.

The LCD also includes a time function which automatically returns to the welcome message if no key is pressed for more than 5 minutes.

```
NO POWER
001 PN D
```

The first row indicates the driver status, according to the following chart:

NO POWER	The device is waiting for the main power supply
DISABLED	The driver is disabled: the main power supply is present and the driver is waiting for the enabling command
ENABLED	Driver enabled
ERROR xx	Error condition: xx is the code identifying the error; see following chapters, in order to decode the error
WARN xx	Warning condition (only for SERCOS II controller): xx is the code which identifies the warning; see next chapters to decode the warning
NO COMM	The field bus is not active and the device is not in service mode

The second row displays the field bus condition and is strictly depending on the communication protocol in use.

#### 7.2.1.1 Controller SERCOS III

In case of field bus SERCOS III, the row consists of 3 fields:

1. the first field consists of three numeric characters; it indicates the node address, expressed in decimal value (in the previous example: 001)
2. the second field consists of two alphanumeric characters indicating the SERCOS communication phase (in the previous example: PN):
  - PN = the bus is not active: the device is waiting for initialization
  - P0 = the bus is in phase 0: the device is being initialized
  - P1 = the bus is in phase 1: the device is being initialized
  - P2 = the bus is in phase 2: the device is being initialized
  - P3 = the bus is in phase 3: the device is being initialized
  - P4 = the bus is in phase 4: in this phase the device is ready to work in realtime
  - PH = the device has been connected to a bus that is already active and is waiting for initialization (hot-plug)
3. the third field consists of only one alphanumeric character: it indicates the connection topology (in the previous example: D):
  - D = topology being identified (Detecting)
  - R = ring topology (Ring)
  - 1 = topology in line with master on port 1

- **2** = topology in line with master on port 2

As far as topology is concerned, please note that the optimal operation condition, to be taken into consideration during the design phase, is the ring topology, because it guarantees the redundancy of master connection; in other words, should one of the two Ethernet connections be lacking, the driver can continue working without interruptions. In this case, the displayed topology will change from R to 1 or 2, depending on the port from where the driver receives the data from the master.

If you select the topology in line, the driver will display 1 or 2, depending on the port from where the driver receives the data from the master.

#### 7.2.1.2 Controller FxIO

XXX.X Hz	The device is generating the frequency XXX.X with the fieldbus active or in service mode
----------	--

#### 7.2.1.3 Controller SERCOS II

001 CP0	The first field consists of three figures and indicates the node address expressed in decimal figures (001 in this example); The second field, in normal conditions, indicates the communication phase (CP0÷CP4); otherwise it displays EXX (XX indicates the error number)
---------	--

#### 7.2.1.4 Analogue controller

0 rpm	It indicates the rotation speed
-------	---------------------------------

#### 7.2.1.5 Service controller

SERVICE	It indicates the service mode
---------	-------------------------------

#### 7.2.1.6 Modbus TCP/IP controller

XXX.X Hz	The device is generating XXX.X frequency; the field bus is active or in service mode
----------	--

### 7.2.2 Access level

By selecting the item LEVEL in the main menu and by pressing the key ↵, you enter the function to insert the password, in order to modify the parameter access level.

```
LEVEL [ 1 ]
PW XXXXX
```

By means of the arrows, it is possible to enter the password, by confirming it by pressing the key ↵. If the password is correct, the LCD will display a message of successful result and will display a new access level.

```
LEVEL [ 3 ]
PW RIGHT
```

By pressing any key, the LCD will return to the main menu. Here are the passwords available for the user:

Level	Password
1	-
2	PROGR
3	TARAT
4	>Reserved to SMITEC<

If no key is pressed for 5 minutes, the system will return to level 1 and it will not be possible to modify the data any longer, unless you enter the password of the next level.

### 7.2.3 Main menu

The following chart shows the menu hierarchy, the entries displayed, the minimum level necessary for the modification



and the description.

<b>Menu</b>	<b>Entry</b>	<b>Lev.</b>	<b>Description</b>
1	>PARAM	-	This section lists all entries that enable you to set the driver parameters and displays the size units measured by the driver.
2	LEVEL	-	Modification of the access level

## 7.2.4 Measure menu

### 7.2.4.1 Models for brushless motor

Menu	Entry	Lev.	Description
1.1	>MEASURES	-	This section displays all size units measured by the driver; moreover, it stores the minimum or maximum values measured for some size units.
1.1.2	VBUS RMS [V]	-	Root mean square voltage
1.1.2	VBUS DC [V]	-	Rectified voltage
1.1.3	VBUS DC MIN [V]	-	Rectified minimum mains voltage
1.1.4	VBUS DC MAX [V]	-	Rectified maximum mains voltage
1.1.5	IQ RMS [A]	-	Root mean square direct current
1.1.6	IQ MAX [A]	-	Maximum direct current
1.1.7	ID RMS [A]	-	Root mean square reverse current
1.1.8	ID MAX [A]	-	Maximum reverse current
1.1.9	IQ RMS MEAN [A]		
1.1.10	IRMS MEAN MAX [A]		
1.1.11	SPEED [rpm]	-	Motor rotation speed
1.1.12	SPEED MAX [rpm]		
1.1.13	SPEED REF [rpm]	-	Preset motor rotation speed
1.1.14	TORQUE [Nm]	-	Torque generated by the motor
1.1.15	TORQUE MAX [Nm]	-	Maximum torque generated by the motor
1.1.16	DRIVE TEMP [°C]	-	Driver dissipator temperature
1.1.17	DRIVE TEMP MAX [°C]	-	Maximum driver dissipator temperature
1.1.18	MOTOR TEMP [°C]	-	Motor temperature
1.1.19	MOTOR TEMP MAX [°C]	-	Maximum motor temperature
1.1.20	BRAKE TEMP [°C] <sup>1</sup>	-	Dynamic brake resistor temperature
e1.1.21	BRAKE TEMP MAX [°C] <sup>1</sup>	-	Dynamic brake resistor maximum temperature
1.1.22	BOARD TEMP [°C]	-	Logic board temperature
1.1.23	VDC MAIN [V]	-	Auxiliary voltage
1.1.24	MEASURE RESET	1	Elimination of the maximum and minimum values recorded Options=No, Yes

Note 1: only for models with dynamic brake

## 7.2.4.2 Models for asynchronous motor

Menu	Entry	Lev.	Description
1.1	>MEASURES	-	This section displays all size units measured by the driver; moreover, it stores the minimum or maximum values measured for some size units.
1.1.2	VBUS RMS [V]	-	Root mean square voltage
1.1.2	VBUS DC [V]	-	Rectified voltage
1.1.3	VBUS DC MIN [V]	-	Rectified minimum mains voltage
1.1.4	VBUS DC MAX [V]	-	Rectified maximum mains voltage
1.1.5	IRMS [A]	-	Root mean square current
1.1.6	IRMS MAX [A]	-	Root mean square maximum current
1.1.7	SPEED [rpm]	-	Motor rotation speed
1.1.8	SPEED MAX [rpm]	-	Maximum value detected of motor rotation speed
1.1.9	DRIVE TEMP [°C]	-	Driver dissipator temperature
1.1.10	DRIVE TEMP MAX [°C]	-	Maximum driver dissipator temperature
1.1.11	MOTOR TEMP [°C]	-	Motor temperature
1.1.12	MOTOR TEMP MAX [°C]	-	Maximum motor temperature
1.1.13	BRAKE TEMP [°C] <sup>1</sup>	-	Dynamic brake resistor temperature
1.1.14	BRAKE TEMP MAX [°C] <sup>1</sup>	-	Dynamic brake resistor maximum temperature
1.1.15	BOARD TEMP [°C]	-	Logic board temperature
1.1.16	IRMS MEAN [A]	-	Average root mean square current in the last 4 minutes
1.1.17	IRMS MEAN MAX [A]	-	Maximum root mean square current in the last 4 minutes
1.1.18	VDC MAIN [V]	-	Auxiliary voltage
1.1.19	MEASURE RESET	1	Elimination of the maximum and minimum values recorded Options=No, Yes

Note 1: only in models with dynamic brake

## 7.2.4.3 SERCOS II COSMOS

Menu	Entry	Lev.	Description
1.1	>MEASURE	-	This section displays all size units measured by the driver; moreover it stores the minimum or maximum values measured for some size units.
1.1.1	VBUS RMS [V]	-	3-phase root mean square voltage at the driver infeed. This value depends on the voltage at the ends of the main filter capacitors. As a consequence, the DC bus voltage variations also affect this value.
1.1.1.2	VBUS DC [V]	-	Driver mains voltage, obtained by adjusting and filtering the input 3-phase voltage. This value depends on the motor load variations.
1.1.1.3	VBUS DC MIN [V]	-	Minimum DC bus voltage. This datum allows monitoring the motor load peaks, due to accelerations, inertial mass increase or mains voltage fluctuations. If this value is below the safety limit, the driver will signal error <b>14</b> .
1.1.1.4	VBUS DC MAX [V]	-	Maximum DC bus voltage. Thanks to this datum, you can infer the limit reached by the DC bus voltage due to the motor decelerations, inertial mass decrease or mains voltage fluctuations. If this value exceeds the safety limit, the driver will signal error <b>10</b> .
1.1.1.5	IQ RMS [A]	-	Calculation of the rms direct current, by measuring the motor phase currents. This is the index of absorption required by the motor.
1.1.1.6	IQ MAX [A]	-	Direct current maximum value.
1.1.1.7	ID RMS [A]	-	Calculation of the rms reverse current, by measuring the motor phase currents.
1.1.1.8	ID MAX [A]	-	Reverse current maximum value.
1.1.1.9	SPEED [rpm]	-	Motor rotation speed.
1.1.1.10	SPEED REF [rpm]	-	Speed value, set by the active controller, that the motor will try to reach. If this value exceeds the limit prescribed by the driver manufacturer, the error <b>16</b> will be displayed.
1.1.1.11	TORQUE [Nm]	-	Torque generated by the motor.
1.1.1.12	TORQUE MAX [Nm]	-	Maximum torque generated by the motor.
1.1.1.13	DRIVE TEMP [°C]	-	Driver dissipator temperature.
1.1.1.14	DRIVE TEMP MAX [°C]	-	Driver dissipator max temperature. If this value exceeds the limit prescribed by the driver manufacturer, the error <b>7</b> will be displayed.
1.1.1.15	MOTOR TEMP [°C]	-	Motor temperature.
1.1.1.16	MOTOR TEMP MAX [°C]	-	Motor max temperature. If the limit set in the parameter <i>TEMP MAX</i> is exceeded, error <b>6</b> will be displayed.
1.1.1.17	BRAKE TEMP [°C]	-	Dynamic brake resistor temperature.
1.1.1.18	BRAKE TEMP MAX [°C]	-	Dynamic brake resistor max temperature. If this value exceeds the temperature limit, error <b>13</b> will be displayed.

1.1.19	INP-DIG	-	Digital input status.
1.1.20	OUT-DIG	-	Digital output status.
1.1.21	INP-A1 [V]	-	Analogue voltage 0-10V applied to input 1.
1.1.22	INP-A1-MIN [V]	-	Minimum value of the analogue input 1.
1.1.23	INP-A1-MAX [V]	-	Maximum value of the analogue input 1.
1.1.24	INP-A2 [V]	-	Analogue voltage 0-10V applied to input 2.
1.1.25	INP-A2-MIN [V]	-	Minimum value of the analogue input 2.
1.1.26	INP-A2-MAX [V]	-	Maximum value of the analogue input 2.
1.1.27	OUT-A [V]	-	Value of the analogue output 0-10V.
1.1.28	OUT-A MAX [V]	-	Max value reached by the analogue output 0-10V.
1.1.29	BOARD TEMP [°C]	-	Logic board temperature.
1.1.30	VDC MAIN [V]	-	Auxiliary voltage.
1.1.31	MEASURE RESET	1	Elimination of max and min values recorded Options=No, Yes.

## 7.2.5 Status menu

### 7.2.5.1 Models for brushless motor

Menu	Entry	Lev.	Description
1.2	>STATUS	-	This section includes detailed information about the driver status.
1.2.1	DRIVE STATE	-	Driver status; see chapter <a href="#">9.2</a> in order to decode any errors
1.2.2	LAST ERRORS	-	List of the last 3 errors; chapter <a href="#">9.2</a> in order to decode any errors
1.2.3	ERROR LIST CLEAR	1	Elimination of the error list. Options=No, Yes
1.2.4	HARDWARE STATE	-	It displays hardware diagnostic information

### 7.2.5.2 SERCOS II COSMOS

Menu	Entry	Lev.	Description
1.2	>STATUS	-	This section includes detailed information about the driver status.
1.2.1	DRIVE STATE	-	Driver status; see chapter <a href="#">10.1</a> to decode the error.
1.2.2	LAST ERR	-	List of the last 8 errors; see chapter <a href="#">10.1</a> to decode the errors.
1.2.3	SERCOS STATE	-	SERCOS interface status; see chapter <a href="#">10.2</a> to decode the errors.
1.2.4	LAST ERR	-	List of the last 8 errors in the SERCOS; see chapter <a href="#">10.2</a> to decode the errors.
1.2.5	HARDWARE STATE	-	It displays hardware diagnostic information.
1.2.6	RESET ERROR	1	It allows cancelling the list of the last errors.

## 7.2.6 Control menu

### 7.2.6.1 Models for brushless motor

Menu	Entry	Lev.	Description
1.3	>CONTROL	-	This section includes the controller setting and the parameters of the driver control system.
1.3.1	CONTROLLER	3	It defines the driver control mode. Options=SERCOS, Service
1.3.2	TORQUE LIMIT [Nm]	2	Torque limit that the motor can generate in this application; this value must be absolutely inferior to the maximum torque indicated by the supplier of the motor and set in the parameter TORQUE MAX [1.4.7]; also refer to parameter KT [1.4.17] in order to determine the maximum current required by the motor. Min=0.00Nm, Max=+58.00Nm
1.3.3	SPEED LIM+ [rpm]	2	Motor speed positive limit Min=0rpm, Max=+7000rpm
1.3.4	SPEED LIM- [rpm]	2	Motor speed negative limit. Min=0rpm, Max=-7000rpm
1.3.5	TORQUE LIM TIME [s]	2	Torque time limit: if the motor torque exceeds the limit value set in TORQUE LIMIT [1.3.2], a timer is increased; as soon as the torque returns below the limit, the timer is decreased. If the total time marked by this timer exceeds the value set in this parameter, the error "Torque time limit exceeded" is displayed. Broadly speaking, a heavy load for a longer time than the limit value will cause the motor disabling and the generation of an error state. Thanks to this parameter, it is possible to find out any jams and/or collisions of mechanical components. Min=0.0s, Max=+32.0s

1.3.6	<b>KPV [A/rpm]</b>	2 Speed proportional gain. The driver continuously detects the rotor speed and compares it to the reference speed rate. The difference between the two values is multiplied by the proportional gain, in order to determine the proportional current. This value of the current is summed up to the current due to the integrative gain. These two values determine the motor current. The higher the difference of speed is, the more the current in the motor is. Through this process, if it is continuous, the motor tends to assume the reference speed, even when the load conditions applied to the motor change. The proportional gain must be usually determined for each specific case, according to the motor application. This value is strongly influenced by the inertial mass applied to the motor shaft. The more the mass is, the lower the gain will be. In the practical tests, it is necessary to find out the gain empirically, by progressively increasing the value, until the motor begins to be unsteady, depending on the motor noise and vibrations. Once you reached the limit, decrease the gain by 10–20%, as a safety margin. Larger size motors usually show higher values than smaller size motors. Min=0.000A/rpm, Max=+3.430A/rpm
1.3.7	<b>KIV [A/G]</b>	2 Speed integrative gain. The angular difference between the reference and the rotor is integrated and multiplied by this factor, in order to determine the integrative current. This current value is summed up to the current due to the proportional gain. They altogether determine the motor current. If you integrate the angular speed within the time, you will obtain an angle; as a consequence, it is possible to express this factor in Ampere per degree; in fact, if you set a speed rate of 1000 rpm and you set this value at 1, the current in the motor will increase by 1 ampere when the rotor slows down and loses 1 degree. Thanks to this datum, it is possible to adjust the rotor speed in a very precise way, with consequent great advantages, especially for the applications requiring high stability while running. Please note that this value is directly proportional to the proportional gain; therefore, it is not possible to set an integrative gain without a proportional gain. This parameter has one negative effect on the motion, especially at low speed rates: hunting. It is necessary to find the correct value of integrative gain, after determining the proportional gain, by progressively increasing it until the hunting begins. Once you reached the limit, decrease the gain value by 10–20%, as a safety margin, as you did for the proportional gain. Min=0.0A/Gr, Max=+540.4A/Gr

1.3.8	KPP [rpm/G]	2	<p>Position proportional gain.</p> <p>The driver continuously detects the rotor position and compares it to the reference position. The difference between the two values is multiplied by the proportional gain, in order to determine the proportional speed.</p> <p>The higher the position difference is, the higher the speed rate applied to the motor will be. Through this process, if it is continuous, the motor tends to assume the reference position, even when the load conditions applied to the motor change.</p> <p>The proportional gain must be usually determined for each specific case, according to the motor application. This value is strongly influenced by the inertial mass applied to the motor shaft. The more the mass is, the lower the gain will be.</p> <p>In the practical tests, it is necessary to find out the gain empirically, by progressively increasing the value, until the motor begins to be unsteady, depending on the motor noise and vibrations. Once you reached the limit, decrease the gain by 10–20%, as a safety margin.</p> <p>Min=0.0rpm/Gr, Max=+2500.4rpm/Gr</p>
1.3.9	KDP [ ]	2	Reserved.
1.3.10	VRMS NOMINAL [V]	3	<p>Driver rated voltage.</p> <p>This value indicates the driver power supply. If the rated voltage of the selected motor is not included in the value range set for the driver, the error "Motor voltage different from driver voltage" will be displayed.</p> <p>Min=230V, Max=+480V.</p>
1.3.11	USE EXT BRAKE	3	<p>Use of the external brake resistance.</p> <p>It enables you to determine whether to use the internal resistance or the external one.</p> <p>Options=No, Yes</p>
1.3.12	CHECK 3PH LINE	3	<p>It enables the control of absence of one or more phases of input line voltage.</p> <p>Options=No, Yes</p>
1.3.13	PWM FREQ [KHz]	3	<p>It sets the switching frequency of the motor output; the higher the frequency is, the more the energy losses are, causing the motor heating; the higher the frequency is, the lower is the noise generated by the switching.</p> <p>Options=4, 8, 12, 16 kHz</p>
1.3.14	CONTROL MODE	-	It displays whether the control is in position, in speed or in torque.



## 7.2.6.2 Models for asynchronous motor

Menu	Entry	Lev.	Description
1.3	>CONTROL	-	This section includes the controller setting and the parameters of the driver control system.
1.3.1	CONTROLLER	3	It determines the driver control mode. Options=FlxIO, Service
1.3.2	ACC RAMP [Hz/s]	2	Frequency ramps acceleration value
1.3.3	DEC RAMP [Hz/s]	2	Frequency ramps deceleration value
1.3.4	FREQ MIN [Hz]	2	Minimum frequency that can be generated by the driver, expressed in hertz. Together with the value VRMS MIN, it determines one of the points defining the line V/f that determines the voltage generated depending on the required frequency.
1.3.5	FREQ NOM [Hz]	2	Rated frequency in hertz. Together with the value VRMS NOM, it determines one of the points defining the line V/f that determines the voltage generated depending on the required frequency.
1.3.6	FREQ MAX [Hz]	2	Maximum frequency that can be generated by the driver, expressed in hertz. By setting higher references, the driver generates this frequency.
1.3.7	VRMS MIN [V]	2	rms voltage, expressed in volt, at minimum frequency. Together with the value FREQ MIN, it determines one of the points defining the line V/f that determines the voltage generated depending on the required frequency.
1.3.8	VRMS NOM [V]	2	Rms voltage, expressed in volt, at rated frequency. Together with the value FREQ NOM, it determines one of the points defining the line V/f that determines the voltage generated depending on the required frequency.

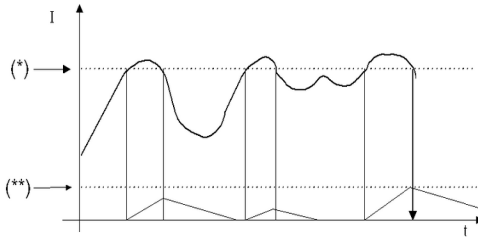
1.3.9	IRMS LIMIT [mA]	<p>2</p> <p>Current limit value, calculated by the driver in order to generate the error 18. The driver takes into consideration the lowest rms current value among the current values of the motor and of the driver. This value is considered as the maximum limit value. In this menu, the rms limit current (*) can be set up to the maximum value.</p> <p>By confirming the set value, it is possible to apply an approximation.</p> <p>Error 18 occurs when the motor torque exceeds the maximum torque set for a longer time than the pre-set time [1.3.5]:</p>  <p>When the current level exceeds the maximum value (*), the timer increases. When the current returns below the maximum level, the timer decreases. If the timer exceeds the pre-set value (**), the error signal is enabled. This is a safety function that the user has at his disposal in order to protect the application.</p>
1.3.10	I TIME LIMIT [mS]	<p>2</p> <p>Time limit for exceeding the limit current(**). This is the time limit for the generation of error 18.</p>
1.3.1	DIRECTION	<p>2</p> <p>Motor rotation direction. This parameter enables you to adjust the motor rotation direction to the pre-set reference.</p> <p>Options=Normal, Inverted.</p>
1.3.12	CHECK 3PH LINE	<p>3</p> <p>It enables the check of absence of one or more phases of input line voltage.</p> <p>Options=Enabled, Disabled.</p>
1.3.13	PWM FREQ [Khz]	<p>3</p> <p>It sets the switching frequency of the motor output; the higher the frequency is, the more the energy losses are, causing the motor heating; the higher the frequency is, the lower is the noise generated by the switching.</p> <p>Options= 4, 8, 10, 12, 16 kHz.</p>

### 7.2.6.3 SERCOS II COSMOS

If you use the SERCOS controller, it is not necessary to set the following parameters, because this operation is directly performed by the control unit, which sends specific messages. The data modified by the user, concerning the SERCOS interface will be overwritten.

Menu	Entry	Lev.	Description
1.3	>CONTROL	-	This section includes the controller setting and the parameters concerning the driver control system.
1.3.1	CONTROLLER	3	It determines the driver control mode. Options=SERCOS, Analog and Service.
1.3.2	TORQUE LIMIT [Nm]	2	Torque limit that the motor can generate in this application; this datum must be lower than the max torque indicated by the motor manufacturer and set in the parameter TORQUE MAX [1.4.7]; please, also refer to parameter KT [1.4.17] in order to determine the max current required by the motor. Min=0.00Nm, Max=+58.00Nm.
1.3.3	SPEED LIM+ [rpm]	2	Motor speed positive limit Min=0rpm, Max=+7000rpm.
1.3.4	SPEED LIM- [rpm]	2	Motor speed negative limit. Min=0rpm, Max=-7000rpm.
1.3.5	TORQUE LIM TIME [s]	2	Torque limit time: if the motor torque exceeds the limit value set in TORQUE LIMIT [1.3.2], a timer is increased; as soon as the torque decreases below the limit, the timer will be decreased. If the total time indicated by this timer exceeds the value set in this parameter, the error "Torque time limit overtaken" will be displayed. In other words, a heavy load for a longer time than the limit value will cause the motor disabling and the generation of an error status. Thanks to this datum, it is possible to find out jams and/or collisions of mechanical components. Min=0.0s, Max=+32.0s.

1.3.6	<b>KPV [A/rpm]</b>	2 Speed proportional gain. The driver continuously detects the rotor speed and compares it to the reference speed rate. The difference between the two values is multiplied by the proportional gain, in order to determine the proportional current. This value of the current is summed up to the current due to the integrative gain. These two values determine the motor current. The higher the difference of speed is, the more the current in the motor is. Through this process, if it is continuous, the motor tends to assume the reference speed, even when the load conditions applied to the motor change. The proportional gain must be usually determined for each specific case, according to the motor application. This value is strongly influenced by the inertial mass applied to the motor shaft. The more the mass is, the lower the gain will be. In practical tests, it is necessary to find out the gain empirically, by progressively increasing the value, until the motor begins to be unsteady, depending on the motor noise and vibrations. Once you reached the limit, decrease the gain by 10–20%, as a safety margin. Larger size motors usually show higher values than smaller size motors. Min=0.000A/rpm, Max=+3.430A/rpm.
1.3.7	<b>KIV [A/G]</b>	2 Speed integrative value. The angular difference between the reference and the rotor is integrated and multiplied by this factor, in order to determine the integrative current. This current value is summed up to the current due to the proportional gain. They altogether determine the motor current. By integrating the angular speed within the time, you will obtain an angle; as a consequence, it is possible to express this factor in Ampere per degree; in fact, if you set a speed rate of 1000 rpm and you set this value at 1, the current in the motor will increase by 1 ampere when the rotor slows down and loses 1 degree. Thanks to this datum, it is possible to adjust the rotor speed in a very precise way, with consequent great advantages, especially for the applications requiring high stability while running. Please note that this value is directly proportional to the proportional gain; therefore, it is not possible to set an integrative gain without a proportional gain. This parameter has one negative effect on the motion, especially at low speed rates: hunting. It is necessary to find the correct value of integrative gain, after determining the proportional gain, by progressively increasing it until the hunting begins. Once you reached the limit, decrease the gain value by 10–20%, as a safety margin, as you did for the proportional gain. Min=0.0A/Gr, Max=+540.4A/Gr.

1.3.8	KPP [rpm/G]	2	<p>Position proportional gain.</p> <p>The driver continuously detects the rotor position and compares it to the reference position. The difference between the two values is multiplied by the proportional gain, in order to determine the proportional speed.</p> <p>The higher the position difference is, the higher the speed rate applied to the motor will be. Through this process, if it is continuous, the motor tends to assume the reference position, even when the load conditions applied to the motor change.</p> <p>The proportional gain must be usually determined for each specific case, according to the motor application. This value is strongly influenced by the inertial mass applied to the motor shaft. The more the mass is, the lower the gain will be.</p> <p>In practical tests, it is necessary to find out the gain empirically, by progressively increasing the value, until the motor begins to be unsteady, depending on the motor noise and vibrations. Once you reached the limit, decrease the gain by 10–20%, as a safety margin.</p> <p>Min=0.0rpm/Gr, Max=+2500.4rpm/Gr.</p>
1.3.9	KDP [ ]	2	<p>Position derivative gain.</p> <p>This gain allows inferring the speed set-point from the difference between two consecutive positions. The derivative gain considerably improves the position control performance.</p> <p>Min=0, Max=+10</p> <p>Up to date, the gain is set to 1. Its modification does not affect the control.</p>
1.3.10	VRMS NOMINAL [V]	3	<p>Driver rated voltage.</p> <p>This value indicates the driver power supply.</p> <p>If the rated voltage of the selected motor is not within the range set for the driver, the error "Motor voltage different from driver voltage" will be displayed.</p> <p>Min=230V, Max=+480V.</p>
1.3.11	USE EXT BRAKE	3	<p>Use of the external brake resistance.</p> <p>It enables you to determine whether to use the internal resistance or the external one.</p> <p>Options=No, Yes.</p>

## 7.2.7 Motor menu

### 7.2.7.1 Models for brushless motor and SERCOS II version

Menu	Entry	Lev.	Description
1.4	>MOTOR	-	In this section it is possible to set the motor type in use and the corresponding parameters
1.4.1	MODEL VVV SSSS	3	<p>Motor model.</p> <p>The first row indicates the model/identification code of the motor you are going to use; the second row displays the data concerning the phase voltage and rated speed.</p> <p>These data can be modified by the next parameters.</p> <p>Options: motor homologated models</p>
1.4.2	VRMS NOM [V]	3	<p>Rms rated voltage indicated by the motor supplier.</p> <p>Min=0V, Max=+1000V</p>

1.4.3	VP MAX [V]	4	Maximum peak voltage that the motor winding can tolerate. Min=0V, Max=+1414V.
1.4.4	IRMS NOM [A]	4	Rms rated current of motor phase.
1.4.5	I MAX [A]	4	Maximum rms current of motor phase.
1.4.6	TORQUE NOM [Nm]	4	Rated torque generated by the motor.
1.4.7	TORQUE MAX [Nm]	4	Maximum rated torque generated by the motor.
1.4.8	SPEED NOM [rpm]	3	Rated speed indicated by the motor supplier. Min=0rpm, Max=+7000rpm
1.4.9	SPEED MAX [rpm]	3	Motor maximum speed, expressed in rpm; beyond this value, the error "too high speed" is displayed immediately. It is recommended to set this value at 100-200 rpm besides the maximum speed required by the application. This parameter is a protection for the mechanical components and for the motor, in case of jams and/or not correct setting. Min=0rpm, Max=+7000rpm
1.4.10	TEMP MAX [°C]	3	Motor maximum temperature; beyond this value, the error "motor temperature: too high" is displayed. This parameter is important for the protection of the motor; this value must be set by the supplier. The supplier's setting is 105°C, but the motor class generally allows you to reach up to 120°C. It is recommended to reach this limit only in the applications which require the maximum power of the motor and anyway after discussing the matter with the supplier. Min=0°C, Max=+155°C
1.4.11	PAIR POLE NUMBER	4	Number of motor poles
1.4.12	ENCODER PULSE	4	Number of impulses of the encoder revolution
1.4.13	NTC TYPE	4	NTC type present in the motor
1.4.14	KP [V/A]	4	Proportional gain of the current ring.
1.4.15	KPI [ ]	4	Integrative gain of the current ring.
1.4.16	FCEM [V/rpm]	4	Counter-electromotive force generated by the motor.
1.4.17	KT [Nm/A]	4	Torque constant. This parameter determines the formula between the motor torque and current: $T[\text{Nm}] = K_T \cdot I_{\text{eff}}[\text{A}]$ .
1.4.18	OF- $\theta$ [G]	4	Reserved.
1.4.19	K- $\theta$ /I [G/A]	4	Reserved.

## 7.2.7.2 Models for asynchronous motor

Menu	Entry	Lev.	Description
1.4	>MOTOR	-	In this section it is possible to set the parameters of the motor type in use.
1.4.1	I RMS [mA]	3	Motor rated current.
1.4.2	I PEAK MAX [mA]	3	Motor maximum peak current. This is the limit for the maximum instant current that can be supplied to the motor. This parameter is a protection for the application.
1.4.3	NTC TYPE	3	It selects the type of NTC sensor for detecting the motor temperature. Options: None (NTC absent ), B57227K.
1.4.4	TEMP MAX [°C]	3	Maximum temperature allowed for the motor. Min 0°C, Max 155 °C.

### 7.2.8 SERCOS menu

The SERCOS menu only exists in the SERCOS II version

#### 7.2.8.1 SERCOS™ standard features (CEI IEC 1491)

SERCOS™ is an international standard which defines an optical serial real-time interface, between a control unit (master) and the devices connected to it (slave or drive).

This interface was designed for industrial machines with multiple drives; in this case, the use of the optical fibre is very important, because it ensures immunity from electromagnetic interferences.

The connection between the control unit and the different drives follows a ring topology, as indicated in the following picture:

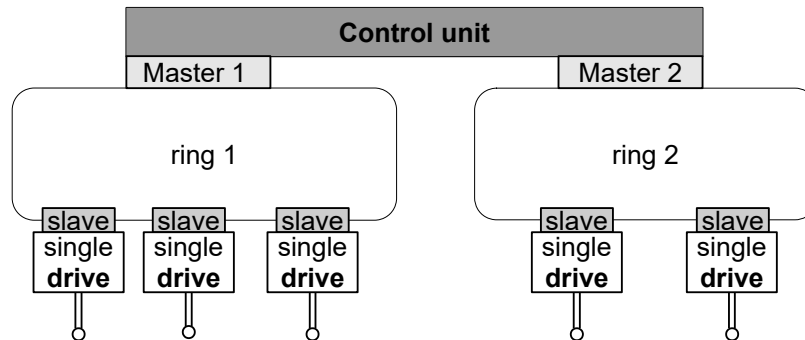

**SERCOS ring topology**

The number of devices that can be serviced per ring depends on the communication cycle time, on the volume of data to be transferred and on the transmission frequency. In normal operating conditions, with a cycle time of 1 ms and a transmission frequency of 4 Mbit/s, it is possible to control up to 8 drives per ring. In standard SERCOS, the cycle time can be selected within 0.062 ms, 0.125 ms, or integer multiples of 0.25 ms: **in our application it is set to 1 ms.**

A control unit can service several ring structures thanks to a master for each ring. The master allows synchronizing and controlling all communication activities concerning the devices in the ring. Direct data exchange between the drives is not allowed.

#### 7.2.8.2 SERCOS interface configuration

Menu	Entry	Lev.	Description
1.5	>SERCOS	-	It includes the SERCOS controller setting.
1.5.1	ADDRESS	3	Driver physical address. The address must be only one for all devices in the SERCOS ring. Valid values must be within a range from 1 to 254. If you set an address not required by the control unit, the error SERCOS 21 will occur.
1.5.2	MBAUD		Communication speed. In standard SERCOS, this parameter is set to 4 MBit/s and 8 MBit/s.

#### 7.2.8.3 SERCOS interface status

It is possible to know the SERCOS interface status at any time, as indicated in the table in paragraph [6.2.5.2](#).

See chapter [10.2](#) for a list of SERCOS errors.

### 7.2.9 Analogue menu

Analogue menu is available only in SERCOS II version.



### 7.2.9.1 Analog controller

In this configuration, the driver receives a reference speed of  $\pm 10V$  from an external device controlling the axes. The software controller will perform the speed and torque regulation, leaving the position check to the axes board. The picture here below shows an example of connection with the "CDP-AXIS" system:

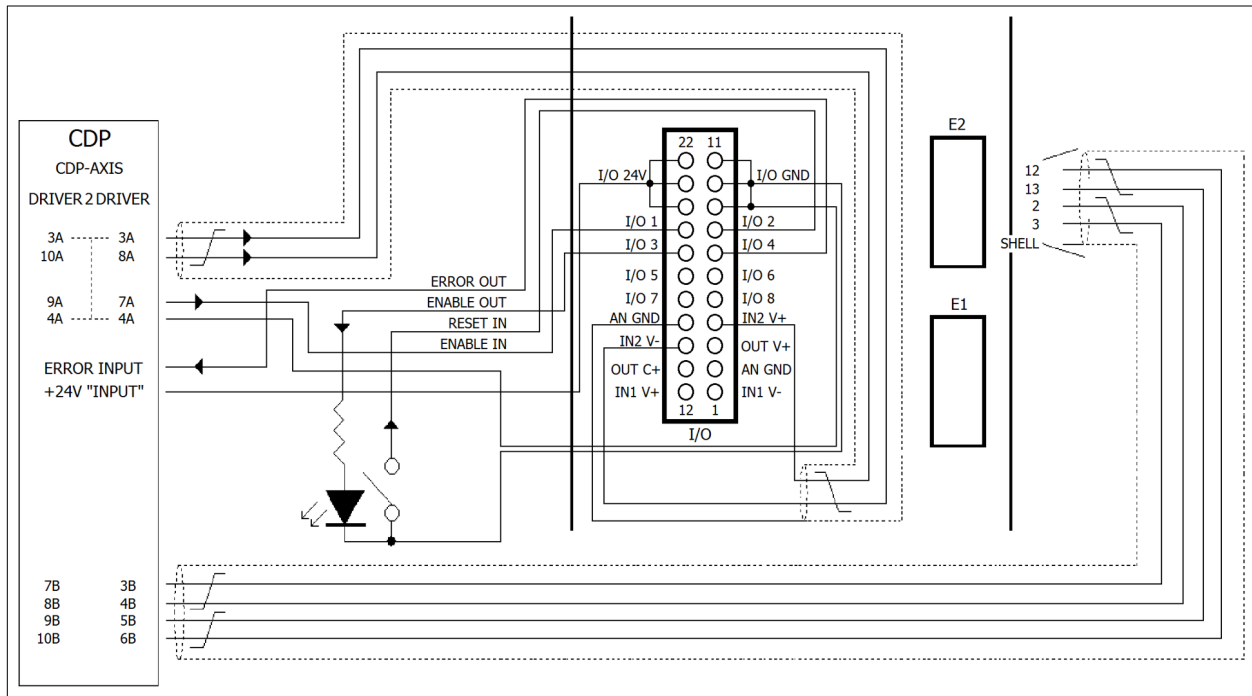

**"CDP-AXIS" board interface**

In order to guarantee a correct signal interface, it is necessary to install 2 resistances of 4.7 k $\Omega$  1/4W (KD031056) between the I/O 24V terminal and the input signals RESET IN and ENABLE IN, as indicated in the electrical diagram. It is recommended to insulate the resistance terminals, by using the sheaths EK050044.

The following table lists the I/O of the analogue controller:

Digital signals		
N° I/O	Signal name	Description
01	ENABLE IN	Enabling signal sent to the driver by the axes board.
02	RESET IN	Reset signal sent to the driver by an external system (for example a push-button). It is used for cancelling the error, if any, in the driver.
03	ENABLE OUT	Active output signal - high. It indicates the driver enabling status (it can be connected to a LED).
04	ERROR OUT	Active output signal – high. It indicates that there is an error in the driver.
05	READY	Active output signal – high. It becomes active after an amount of time that can be set from the LCD when the driver is ready to be enabled. It can be used instead of ERROR OUT when the enabling request immediately follows the ERROR OUT disabling.
06	NOT IN USE	-
07	NOT IN USE	-
08	NOT IN USE	-

### 7.2.9.2 Analogue controller configuration

The configuration consists in setting the parameters concerning the voltage of IN-2 analogue input, so that the speed reference sent to the driver by the axes external board is interpreted correctly. It is also possible to configure the active

logic level of the two input signals ENABLE IN and RESET IN.

Menu	Entry	Lev.	Description
1.6	>ANALOG	-	It includes the setting concerning the analogue controller.
1.6.1	DRIVE STATE	-	It displays the analogue controller status.
1.6.2	RESET ERROR	1	It allows cancelling the error condition.
1.6.3	RESET LEVEL	3	L = The reset signal is active and low. H = The reset signal is active and high.
1.6.4	ENABLE LEVEL	3	L = The enabling signal is active and low. H = The enabling signal is active and high.
1.6.5	K-VIN/VEL [V/rpm]	2	Speed constant of the analog input, expressed in rpm per input Volt. It allows modifying the gain, to transform the speed analogue reference in rpm, according to the following formula:  $Vel = Kv \cdot (Vin + Voff)$ where, Vel = speed in rpm required to the motor; Kv = speed constant; Vin = voltage analogue reference (from -10V to +10V); Voff = analogue input offset (from -5V to +5V).  It is recommended to use the whole dynamic range of the input, so as to increase the signal/noise ratio. Min=0, Max=+350.
1.6.6	OFFSET [V]	2	Offset voltage of the analogue input, expressed in Volt. This voltage is added algebraically to the voltage representing the speed analogue reference sent to the driver. In any case, this sum can not exceed the limits of the analogue input ( $\pm 10V$ ). For further information, please refer to Kv data. Min=-5.000, Max=+5.000.
1.6.7	READY TIME [s]		Delay for the activation of the READY-OUT signal, when the driver is ready to be enabled. It allows postponing the request of enabling, starting from the moment when the driver is no longer in error status. Min=0, Max=+20.

### 7.2.9.3 Analogue controller status

The VISIO displays some "Messages" about the analogue interface status.

Please remember that the priority of the messages about the analogue interface is lower than the "driver errors". In case of simultaneous messages of driver error and analogue interface, the driver error will be signalled first.

A message concerning the analogue interface does not require to carry out the procedure to cancel it; it will be automatically cancelled when the required conditions are fulfilled. By contrast, the driver error must be cancelled by means of the option RESET ERROR on the LCD. If the error persists, the operation will have no effect.

WARNING codes	
Warning text	Explanation
WARN 50	At the driver start, if the auxiliary voltage is available, you must wait for the minimum mains voltage before proceeding.

WARN 51	At the driver start, the driver reset signal must not be activated.
WARN 52	At the driver start, the motor enabling signal must not be activated

### 7.2.10 Service menu

The service menu is present only when the parameter CONTROLLER is set as SERVICE [1.3.1].

#### 7.2.10.1 Models for brushless motor and for SERCOS II COSMOS

Menu	Entry	Lev.	Description
1.7	>SERVICE	-	This section includes the parameters for controlling the motor by means of the VISIO.
1.7.1	DRIVE STATE	-	Driver status; see chapter 9.2 or 10.1 in order to decode any errors
1.7.2	ERROR RESET	3	Error cancellation. If the error is irretrievable or the problem is not solved, the error will recur again. Options=No, Yes
1.7.3	CONTROL MODE	-	Motor control mode in SERVICE mode.
1.7.4	ENABLE DRIVE	3	Driver enabled to SERVICE mode. If the driver is not in error state, it will be possible to enable it, by setting this entry. In this case, the motor will be energized. If the values of the parameters RAMP and SPEED REF, [1.5.5] and [1.5.6], are different from zero, the motor will be operated. WARNING: if the setting of the parameters RAMP and SPEED REF is carried out while the driver is disabled, no ramp will be executed, but the system will try to reach the final speed as soon as it is enabled. Options:No, Yes
1.7.5	RAMP [rpm/s]	3	It determines the acceleration/deceleration ramp of the motor for the mode "SERVICE control VELOCITY". Min=0rpm/s, Max +3500rpm/s
1.7.6	SPEED REF [rpm]	3	It sets the motor speed for the mode "SERVICE control VELOCITY". Min=-3500rpm, Max=+3500rpm
1.7.7	SPEED [rpm]	-	Motor rotation speed

#### 7.2.10.2 Models for asynchronous motor

Menu	Entry	Lev.	Description
1.7	>SERVICE	-	In this section it is possible to command the motor and set some parameters locally, by means of the interface VISIO 3000. For this purpose, it is necessary to set the parameter CONTROLLER as SERVICE [1.3.1].
1.7.1	ERROR RESET	3	It allows you to come out from the error condition. Options:No, Yes.
1.7.2	ENABLE DRIVE	3	It allows you to enable or disable the driver. Options: Enabled, Disabled.

1.7.3	ACC RAMP [Hz/s]	3	Frequency ramps acceleration value
1.7.4	DEC RAMP [Hz/s]	3	Frequency ramps deceleration value
1.7.5	FREQ REF [Hz]	3	It allows you to set the speed reference within a range from -128,0 to +128,0 Hz.
1.7.6	FREQ OUT [Hz]	-	It displays the voltage frequency actually generated by the driver.
1.7.7	SPEED [rpm]	-	If present, the encoder displays the motor rotation speed expressed in revolutions per minute.
1.7.8	DIRECTION	3	Motor rotation direction. This parameter allows you to adjust the motor rotation direction to the pre-set reference. Options=Normal, Inverted.

### 7.2.11 External brake menu

The external brake menu is present only if the model is equipped with the dynamic brake output.

#### 7.2.11.1 Models for brushless motor and for SERCOS II COSMOS

Menu	Entry	Lev.	Description
1.8	>E-BRAKE	-	This section includes the parameters for the external brake resistor.
1.8.1	RESISTANCE [Ω]	3	This is the value expressed in ohm of the resistor connected externally. This parameter is set by the supplier. Min=+30Ω, Max=+500Ω
1.8.2	RTH [°C/W]	3	Thermal coefficient of the external resistance. It represents the temperature increase, expressed in °C, depending on the power that the resistor must dissipate, expressed in W. The best dissipation conditions are possible with low values of this constant. This datum is set by the supplier. Min=+0.1°C/W, Max +10.0°C/W
1.8.3	ENV TEMP [°C]	3	Average ambient temperature at which the external resistor is situated. Min=0°C, Max=+500°C
1.8.4	POWER NOM [W]	3	Rated power that can be dissipated by the external resistor. This datum is set by the supplier. Min=0W, Max=+2000W
1.8.5	TEMP MAX [°C]	3	Maximum temperature that can be reached by the external resistor. If this limit is overtaken, the error "Brake resistance temperature too high" is displayed. This datum is set by the supplier. Min=0°C, Max=+350°C

#### 7.2.11.2 Models for asynchronous motor

Menu	Entry	Lev.	Description
1.8	>E-BRAKE	-	This section includes the parameters for the external brake resistor.
1.8.1	USE EXT BRAKE	3	This parameter allows you to select the external brake resistance, in order for the driver to be able to apply the correct thermal model for measuring the temperature of the external brake resistance according to parameters [1.6.2] and [1.6.4].

1.8.2	RESISTANCE [Ω]	3	This is the value expressed in ohm of the resistor connected externally. This parameter is set by the supplier. Min=+30Ω, Max=+500Ω
1.8.3	POWER NOM [W]	3	Rated power that can be dissipated by the external resistor. This datum is set by the supplier. Min=0W, Max=+2000W
1.8.4	RTH [°C/W]	3	Thermal coefficient of the external resistance. It represents the temperature increase, expressed in °C, depending on the power that the resistor must dissipate, expressed in W. The best dissipation conditions are possible with low values of this constant. This datum is set by the supplier. Min=+0.1°C/W, Max +10.0°C/W
1.8.5	MAX TEMP [°C]	3	Maximum temperature that can be reached by the external resistor. If this limit is overtaken, the error "Brake resistance temperature too high" is displayed. This datum is set by the supplier. Min=0°C, Max=+350°C
1.8.6	ENV TEMP [°C]	3	Average ambient temperature at which the external resistor is situated. Min=0°C, Max=+150°C

### 7.2.12 Input/output menu

The input/output menu is available in SERCOS II version only.

Menu	Entry	Lev.	Description
1.9	>I/O	-	It includes the setting and the status of the digital I/O and of the analog output.
1.9.1	OUT BACKUP	2	It defines the behaviour of the power digital outputs when the mains power is absent. 0 = In case of lack of the mains power, the output status is set to 0 (output OFF). 1 = In case of lack of the mains power, the output status is maintained. This function allows setting the power digital outputs in power saving mode, which is very useful for the backup batteries.
1.9.2	OUT TYPE	2	In this section, it is possible to select the type of analogue output. In fact, the connector features one output only: this parameter defines whether the user will use current output (4-20mA) or voltage output (0-10V). If you set current output, the voltage value will display a calibration error. The same problem will occur in case you set voltage output: the current output value will display a calibration error.
1.9.3	SET OUT	2	It sets the size unit to be transferred to the analogue output: <i>SERCOS</i> : the output value is cyclically sent by the control unit of the SERCOS interface. For this setting, the active controller must be "SERCOS". <i>IQ</i> : Direct current reference (active component of the current vector). <i>VEL</i> : Motor current speed reference. <i>ABS-VEL</i> : Reference of the absolute value of the motor current speed. <i>ERR-VEL</i> : Speed error: this is the difference between the motor actual speed and the preset speed. <i>ERR-POS</i> : Position error: this is the difference between the motor actual position and the preset position.
1.9.4	OFFSET [V]	2	See next parameter "OFFSET [mA]".

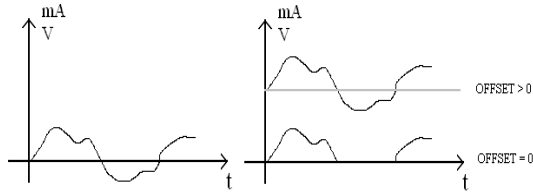
1.9.5	<b>OFFSET [mA]</b>	<p>2</p> <p>These parameters define the offset value which will be added to the analogue output. Since the output is only one, the two parameters depend on each other; therefore, the setting of one parameter will imply the modification of the other one. If you select current output, modify OFFSET[mA]; if you select voltage output, modify OFFSET[V].</p> <p>The setting of an offset value different from zero is very useful in case of negative value of the size unit taken into consideration (IQ,VEL,ERR-VEL,ERR-POS). Since the dynamics of the output signal is strictly positive (4÷20 mA or 0÷10 V), the negative part of the size unit would cause a null output.</p> 
-------	--------------------	--

The following parameters represent the proportionality constants between the analogue output voltage and the selected reference value ( $GRif$ ), according to the following formula:

$$V_{out} = \frac{GRif}{[K - VOUT / GRif]} + [OFFSET [V]]$$

where,

$V_{out}$  = analogue output voltage;

$GRif$  = reference value (IQ, VEL and ABS-VEL, ERR-VEL, ERR-POS);

$[K - VOUT / GRif]$  = proportionality constant;

$[OFFSET[V]]$  = offset value added to the analogue output.

The setting of these constants, as well as of the offset value, allows defining the analogue output dynamics and consequently the full scale value:

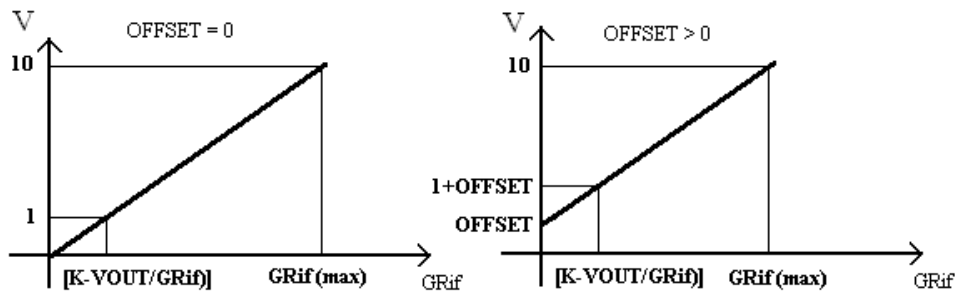

1.9.6	<b>K-VOUT/IQ</b>	<p>2</p> <p>Proportionality constant of the IQ current, expressed in A per V. It defines how many Ampere of the IQ current correspond to <b>1 volt</b> of the output voltage added to an offset value. This parameter is used when the analogue output is set to provide the reference of the IQ current.</p>
1.9.7	<b>K-VOUT/VEL</b>	<p>2</p> <p>Proportionality constant of the motor speed, expressed in rpm per Volt. It defines how many rpm of the motor correspond to <b>1 volt</b> of the output voltage added to an offset value. This parameter is used when the analogue output is set to provide the current speed reference of the motor (VEL and ABS-VEL).</p>

1.9.8	<b>K-VOUT/VEL-ERR</b>	2	Proportionality constant of the motor speed error, expressed in rpm per V. It defines how many rpm of the speed error correspond to <b>1 volt</b> of the output voltage added to an offset value. This parameter is used when the analogue output is set to provide the speed error reference ERR-VEL.
1.9.9	<b>K-VOUT/POS-ERR</b>	2	Proportionality constant of the motor position error, expressed in Degrees per V. It defines how many Degrees of position error correspond to <b>1 volt</b> of the output voltage added to an offset value. This parameter is used when the analogue output is set to provide the position error reference ERR-POS.

The following parameters represent the proportionality constants between the analog output current and the selected reference value ( $GRif$ ), according to the following formula:

$$I_{out} = \frac{GRif}{[K-IOUT/GRif]} + [OFFSET[mA]] + 4mA$$

where,

$I_{out}$  = analogue output current;

$GRif$  = reference value (IQ, VEL and ABS-VEL, ERR-VEL, ERR-POS);

$[K-IOUT/GRif]$  = proportionality constant;

$[OFFSET[mA]]$  = offset value added to the analog output.

The setting of these constants, as well as of the offset value, allows defining the analog output dynamics and consequently the full scale value:

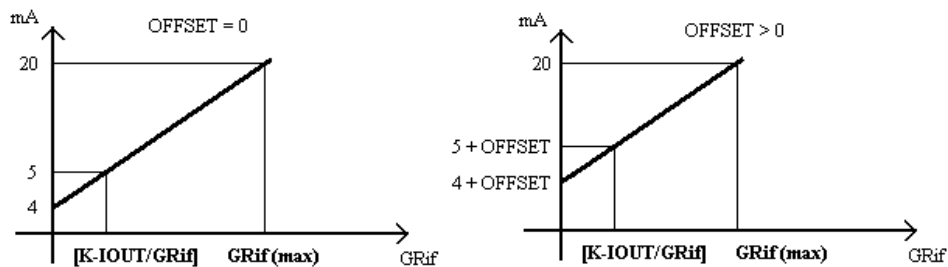

1.9.10	<b>K-IOUT/IQ</b>	2	Proportionality constant of the IQ current, expressed in A per mA. It defines how many Ampere of the IQ current correspond to <b>5 mA</b> of the output current added to an offset value. This parameter is used when the analogue output is set to provide the reference of the IQ current.
1.9.11	<b>K-IOUT/VEL</b>	2	Proportionality constant of the motor speed, expressed in rpm per mA. It defines how many rpm of the motor correspond to <b>5 mA</b> of the output current added to an offset value. This parameter is used when the analogue output is set to provide the current speed reference of the motor (VEL and ABS-VEL).
1.9.12	<b>K-IOUT/VEL-ERR</b>	2	Proportionality constant of the motor speed error, expressed in rpm per mA. It defines how many rpm of the motor correspond to <b>5 mA</b> of the output current added to an offset value. This parameter is used when the analogue output is set to provide the motor speed error reference ERR-VEL.
1.9.13	<b>K-IOUT/POS-ERR</b>	2	Proportionality constant of the motor position error, expressed in Degrees per mA. It defines how many Degrees of motor position error correspond to <b>5 mA</b>



			of the output current added to an offset value. This parameter is used when the analogue output is set to provide the motor position error reference ERR-POS.
--	--	--	---

### 7.2.13 Driver menu

#### 7.2.13.1 Models for brushless motor

Menu	Entry	Lev.	Description
1.10	>DRIVE	-	This section includes the parameters for the driver configuration.
1.10.1	MODEL	-	Code indicating the driver features, as per chapter <a href="#">3.2.2</a> .
1.10.2	VRMS NOMINAL [V]	3	Rms rated voltage for the driver. This parameter must be set according to the mains voltage. The value must coincide with the rms rated voltage of the selected motor [1.4.2]. Otherwise, the error 21 will occur (motor voltage different from driver voltage). Min=+230V, Max=+480V
1.10.3	VBUS DC MAX [V]	4	Maximum DC BUS voltage, beyond which the error 10 occurs (DCBUS voltage beyond maximum limit).
1.10.4	VBUS DC MIN [V]	4	Minimum DC BUS voltage, below which the error 14 occurs (DCBUS voltage too low).
1.10.5	VDC BRAKE ACT[V]	4	DC BUS voltage for the intervention of the brake resistor.
1.10.6	IRMS NOM [A]	3	It sets the rms rated current that will be supplied to the driver. This parameter allows you to limit the current depending on the application to be controlled and according to the exigencies of thermal dissipation. Min=+0.01A, Max=depending on the model and on the switching frequency.
1.10.7	IRMS MAX [A]	4	Maximum rms current that can be supplied by the driver.
1.10.8	SPEED MAX[rpm]	4	Maximum motor rotation speed that can be controlled by the driver.
1.10.9	DRIVE TEMP MAX [°C]	4	Maximum temperature allowed for the driver dissipator.
1.10.10	INT BRAKE TMAX [°C]	4	Maximum temperature allowed for the internal brake resistor.
1.10.11	USE EXT BRAKE	3	Use of the external brake resistor. It allows you to determine whether to use the internal resistor or the external one. If it is set at "No", the driver will use the internal resistor; if it is set at "Yes", the driver will use the external one. Warning: if you set the external resistor use, but you connect the internal one, you can damage it. Options: No, Yes
1.10.12	DISABLE FAN ERR	4	It disables the error of the cooling fan speed.
1.10.13	DISABLE VDC ERR	4	It disables the error of 24 Volt power supply.
1.10.14	DISABLE HST ERR	4	It disables the error of drive overtemperautre.

## 7.2.13.2 Models for asynchronous motor

Menu	Entry	Lev.	Description
1.10	>DRIVE	-	In this section you can set the driver parameters.
1.10.1	MODEL	-	Code indicating the driver features, as per chapter 3.2.2.
1.10.2	VRMS NOM [V]	3	Driver rated voltage. This parameter determines the voltage limits, in order to enable the driver.
1.10.3	I RMS NOM [mA]	4	Rms rated current that the driver can supply. This parameter depends on the driver model and on the PWM frequency.
1.10.4	I PEAK MAX [mA]	4	It displays the maximum peak current that the driver can supply.
1.10.5	FAN TEMP ON [°C]	3	It sets the temperature for the activation of the cooling fan. For the models equipped with brake resistance, the fan intervention is immediate.
1.10.6	DRIVE TEMP MAX [°C]	4	It sets the maximum temperature for the driver operation. Default 100°C. Min 0°C, Max 155°C
1.10.7	DISABLE VDC ERR	4	It disables the error of 24 Volt power supply.
1.10.8	DISABLE HST ERR	4	Drive overheating error disabled.

## 7.2.13.3 SERCOS II COSMOS

Menu	Entry	Lev.	Description
1.10	>DRIVE	-	This section includes the parameters for the driver configuration.
1.10.1	MODEL	-	Code indicating the driver features, as per chapter 3.2.2.
1.10.2	VRMS NOMINAL [V]	3	Driver rms rated voltage. This parameter must be set according to the mains voltage. The value must coincide with the rms rated voltage of the selected motor [1.4.2]. Otherwise, the error 21 will occur (motor voltage different from driver voltage). Min=+230V, Max=+480V.
1.10.3	VBUS DC MAX [V]	4	Maximum DC BUS voltage, beyond which the error 10 occurs (DCBUS voltage beyond maximum limit)
1.10.4	VBUS DC MIN [V]	4	Minimum DC BUS voltage, below which the error 14 occurs (DCBUS voltage too low).
1.10.5	VDC BRAKE ACT [V]	4	DC BUS voltage for the intervention of the braking resistor.
1.10.6	IRMS NOM [A]	3	It sets the rms rated current supplied by the driver. This parameter allows limiting the current according to the application to be controlled or due to thermal dissipation of the driver. Min=+0.01A, Max=depending on the model and on the switching frequency.
1.10.7	IRMS MAX [A]	4	Maximum rms current that can be supplied by the driver.
1.10.8	SPEED MAX [rpm]	4	Maximum motor rotation speed that can be controlled by the driver.

1.10.9	DRIVE TEMP MAX [°C]	4	It sets the driver max operating temperature.
1.10.10	INT BRAKE TMAX [°C]	4	Max temperature allowed for the internal braking resistor.
1.10.11	USE EXT BRAKE	3	Use of the external braking resistor. It determines whether to use the internal resistor or the external one. If it is set to "No", the driver will use the internal resistor; if it is set to "Yes", the driver will use the external one. Warning: if you set the external resistor use, but you connect the internal one, you can damage it. Options: No, Yes.
1.10.12	PWM FREQ [KHz]	4	It disables the speed error of the cooling fan.

### 7.2.14 Ethernet menu

The Ethernet menu is present only in models equipped with controller SERCOS III.

Menu	Entry	Lev.	Description
1.11	>ETHNET	-	In this section it is possible to view and set the parameters of the Ethernet connection.
1.11.1	MAC ADDR	-	It displays the MAC ADDRESS.
1.11.2	IP ADDR	-	Displays the IP address and allows you to set it (in some firmware versions the writing MAC ADDRESS appears instead of IP ADDRESS).
1.11.3	ENABLE DHCP	4	It enables the DHCP client.

### 7.2.15 Encoder menu

The encoder menu is present only in the models for asynchronous motor.

Menu	Entry	Lev.	Description
1.12	>ENCODER	-	This section includes the parameters for the encoder.
1.12.1	ENCODER TYPE	3	Type of encoder present. Options: None, Incr.
1.12.2	ENCODER DIR	3	Encoder direction. This parameter gives you the possibility to reverse or not the reference given by the encoder. Options: Normal, Inverted.
1.12.3	ENCODER RES	3	Number of impulses of the encoder revolution. This parameter is essential for a correct detection of the motor rotation speed [1.1.7].

## 7.2.16 VISIO menu

### 7.2.16.1 Models for brushless motor

Menu	Entry	Lev.	Description
1.13	>VISIO	-	This section includes the operation options of the VISIO 3000.
1.13.1	ALWAYS LIGHT ON	1	It sets the LCD lighting always on or with the possibility to switch off by means of a timer. By setting "No", the light will switch off after some minutes of inactivity. Options: No, Yes
1.13.2	RESET DISPLAY	1	It sets the return to the status display, by means of a timer. By setting "Yes", the driver status will be displayed after 5 minutes of inactivity. Options: No, Yes

### 7.2.16.2 Models for asynchronous motor

Menu	Entry	Lev	Description
1.13	>VISIO	-	This section includes the operation options of the VISIO 3000.
1.13.1	LANGUAGE	2	It sets the language of the messages. Options: English, Italian.
1.13.2	ALWAYS LIGHT ON	1	It sets the LCD lighting always on or with the possibility to switch off by means of a timer. By setting "No", the light will switch off after some minutes of inactivity. Options: No, Yes

### 7.2.16.3 SERCOS II COSMOS

Menu	Entry	Lev.	Description
1.13	>VISIO	-	This section includes the operating options of the VISIO 3000.
1.13.1	ALWAYS LIGHT ON	1	It sets the LCD lighting always on or with the possibility to switch off by means of a timer. By setting "No", the light will switch off after some minutes of inactivity. Options: No, Yes.
1.13.2	RESET DISPLAY	1	It sets the return to the status display, by means of a timer. By setting "Yes", the driver status will be displayed after 5 minutes of inactivity. Options: No, Yes.
1.13.3	LANGUAGE	2	It sets the language of the messages. Options: English, Italian.

### **7.3 Reset to factory parameters**

There is the possibility of resetting the drive and restoring it to the factory parameters; this operation must be carried out if incorrect parameterizations have been made or if parameters have been lost.

It is possible to restore the drive by using the "Arrow up" and "Arrow down" buttons on the VISIO 3000 module; then with the drive off, press the two central buttons of the VISIO 3000 and at the same time insert the 24Vdc power supply connector. As proof that the operation has been performed correctly, the VISIO 3000 will display the message "EEPROM INIT" for about 3 seconds, after which the message will disappear.

## 8 LEDs and address (FlxIO, SERCOS III and Modbus TCP)

The drivers COSMOS 3000 are equipped with several status LEDs and with selectors for the field bus address setting. The LEDs are of different colours and are grouped according to their function, in order to be easily understood; the number and colour depends on the COSMOS models, according to the integrated field bus. Also the number of address selectors changes according to the integrated field bus and can vary from 0 to 2.

### 8.1 Address setting

As you know, the field buses need to identify the devices connected to them in an unequivocal way, in order to ensure a precise data communication. In COSMOS 3000 equipped with Modbus TCP field bus, identification takes place by setting the IP address in the Visio Ethernet menu (7.2.4).

In COSMOS 3000 equipped with field bus SERCOS III and FlxIO, the identification (address) is set by means of rotary selectors installed on the front side.

The address must be unequivocal, otherwise the bus will not operate correctly.

Rotary selectors feature an hexadecimal notation

Here is the decimal-to-hexadecimal conversion table:

<b>Decimal</b>	0	1	2	3	4	5	6	7	8	9	10	11	12	13	14	15
<b>Hexadecimal</b>	0	1	2	3	4	5	6	7	8	9	A	B	C	D	E	F

If only one selector (ADL) is present, the address will correspond to the number selected by the selector arrow.

If there are two selectors (ADL and ADH), the address will correspond to the number selected by the ADH arrow, multiplied by 16 and summed up to the number selected by the ADL arrow. Therefore:

$$Address = ADH * 16 + ADL$$

The address 0 can not be used.

Example 1: ADH set on A, ADL set to 5; the hexadecimal address is A5, the decimal address is  $10 * 16 + 5 = 165$

Example 2: ADH set to 7, ADL set on E; the hexadecimal address is 7E, the decimal address is  $7 * 16 + 14 = 126$

Example 3: ADH set to 0, ADL set on B; the hexadecimal address is 0B, the decimal address is  $0 * 16 + 11 = 11$

## 8.2 LEDs "LINE" and "24VDC"

The two LEDs "LINE" and "24VDC" indicate the status of the main power supply (LINE) and auxiliary power supply (24VDC).

LINE	24VDC	LINE	24VDC
<50V	X	OFF	X
>50V and < VDC BUS MIN	X	FLASH	X
>VDC BUS MIN	X	ON	X
X	<~16V	X	OFF
X	>~16V and <20,4	X	FLASH
X	>21,4	X	ON

*X = Not consistent*

If the main power supply LINE is inferior to VDC BUS MIN, the driver is disabled.

If the auxiliary power supply 24VDC is inferior to 20,4V, the driver might not operate correctly.

## 8.3 LEDs "FLT" and "STS"

FLT and STS are LEDs indicating the driver general status.

FLT (fault) consists of a red LED, while STS (status) consists of an orange LED and a green LED.

Status	FLT	STS	
Hardware error or critical firmware	ON	Seq.	Seq.
Driver retrievable error	OFF	Seq.	Seq.
Driver ready	OFF	OFF	OFF
Driver enabled	OFF	OFF	ON

If the STS LEDs are flashing, the following sequence occurs:

Seq.	Meaning	STS	
1	Error code start	FLASH	FLASH
2	It indicates the tens in the error code	FLASH D	OFF
3	It indicates the units in the error code	OFF	FLASH U
4	Repetition of the sequence from point 1		

After the simultaneous flashing of the orange and green LEDs, count the number of flashing of the orange LED and you will obtain the number of tens in the error code; if you count the flashing of the green LED, you will obtain the number of units in the error code.

Example: 1 flashing of the orange LED, 4 flashing of the green LED: the error code will be 14.

See chapter [9.1](#) for the error decoding.

## 8.4 LEDs I1, I2 and TO

I1, I2 and TO concern the STO safety system. Their meaning is specified in details at paragraph [6.2.3](#).

## 8.5 LEDs A and L

The LEDs A and L concern the field bus connections (F1 and F2). The field bus FlxIO has no LED.

For the field bus Ethernet IP/SERCOS III, the LEDs have the following meaning:

Meaning	A	L
Disconnected cable or no network signal	X	OFF
Network signal present, but data packs absent	OFF	ON
Network signal present, data packs present	FLASH	ON



## 8.6 LEDs FBS

FBS LEDs (fieldbus status) concern the field bus status; the number of LEDs and the colours depend on the integrated field bus.

### 8.6.1 Field bus FxIO

Status	FBS		
Field bus firmware updating	ON		FLASH S
Field bus hardware error	ON		ON
Field bus hardware error	ON		OFF
Field bus initialization	OFF		FLASH S
Field bus communication error	OFF		FLASH Q
Field bus Master not active or regular communication	OFF		ON

FLASH S = 1Hz, FLASH Q = 8Hz

### 8.6.2 Field bus SERCOS III

The signal is given according to the specifications included in the document "Generic Device Profile" version 1.1.2.1.1 dated 31 March 2009, developed by SERCOS III Working Group - TWG Profile".

Status	FBS		
On, CP4 no error, priority 0 (CPT stm)	OFF	OFF	ON
Loopback, changed from fast-forward to loopback, priority 2	OFF	OFF	FLASH
Communication error, depending S-0-1003, priority 0 (CPT stm)	FLASH	OFF	FLASH
SIII C1D, class 1 diagnosis, priority 1	ON	OFF	OFF
On, CP0..CP3, priority 0 (CPT stm)	OFF	ON	OFF
Identification, address allocation or configuration error or other identification purposes, priority 3	OFF	FLASH	OFF
Off, no SERCOS communication, priority 0 (CPT stm)	OFF	OFF	OFF

## 9 LEDs and address (SERCOS II model)

The COSMOS 3000 - version SERCOS II is equipped with several status LEDs.

The LEDs are of different colours and are grouped according to their function, in order to be easily understood.

### 9.1 Address setting

The address must be set by means of Visio operator interface (see paragraph [6.2.8.2](#) for the setting) and must be unequivocal, otherwise the bus will not operate correctly.

### 9.2 P, E, O LEDs

P orange LED indicates that the main power supply is available.

E orange LED indicates that the driver is enabled.

O orange LED indicates that the digital I/O section is enabled.

### 9.3 FBS LEDs

These are signalling LEDs.

F is a red LED, B is an orange LED, whereas S is a green LED.

- If LED F is on, with a fixed light, LEDs B and S indicate the driver error code (see chapter [10.1](#) for error decodification).

Status	FBS		
Driver error	ON	Seq.	Seq.

- If LED F is flashing, LEDs B and S indicate the SERCOS error codes (see chapter [10.2](#) for the error decodification).

Status	FBS		
SERCOS error	FLASH	Seq.	Seq.

In both cases, LEDs B and S are flashing in the following sequence:

Seq.	Meaning	B	S
1	Error code start	FLASH	FLASH
2	It indicates the tens in the error code	FLASH D	OFF
3	It indicates the units in the error code	OFF	FLASH U
4	Repetition of the sequence from point 1		

After the simultaneous flashing of the orange and green LEDs, count the number of flashings of the orange LED and you will obtain the number of tens in the error code; if you count the number of flashings of the green LED, you will obtain the number of units in the error code.

Example: 1 flashing of the orange LED, 4 flashings of the green LED: the error code will be 14.

The driver error message takes priority over the SERCOS error message.

### 9.4 FLT LED

The red Fault LED switches on only in case of a serious hardware error.

### 9.5 D LED

It indicates distortion and/or interruption of SERCOS II optical signal.

## 10 Error codes (FlxIO, SERCOS III and Modbus TCP)

The drivers COSMOS 3000 include two series of error codes: one for the errors deriving from the control board and one for the errors deriving from external causes or from the power section.

### 10.1 Internal errors

These errors derive from the control circuits or from the firmware. They indicate critical problems which imply the stop of all the driver activities.

The error code is represented exclusively on the status LEDs (not on VISIO), according to the modes specified in chapter [8.3](#).

Cod.	Error	Description
01	FATAL_ERROR_INT_RAM	Error in the test of the internal RAM
02	FATAL_ERROR_INT_FLASH	Error in the test of the internal FLASH
03	FATAL_ERROR_EXT_RAM	Error in the test of the external RAM
04	FATAL_ERROR_EXT_FLASH	Error in the test of the external FLASH
05	FATAL_ERROR_ILLEGAL_OP	SW/HW error in the execution of the CPU instructions
06	FATAL_ERROR_ADDRESS	SW/HW error in the execution of the CPU instructions
07	FATAL_ERROR_NMI	Unexpected, non maskable interrupt HW
08	FATAL_ERROR_BANK	SW/HW error in the system interrupt control
09	FATAL_ERROR_MATH	SW/HW error in the execution of the CPU instructions
10	FATAL_ERROR_TRAPA	Unexpected interrupt SW
11	FATAL_ERROR_INT	Unexpected, maskable interrupt HW
12	FATAL_ERROR_TASK	Task creation OS error
13	FATAL_ERROR_RESOURCE	Resource allocation OS error
14	FATAL_ERROR_HW_TEMP	Internal temperature beyond the limits (>85°C)
15	FATAL_ERROR_HW_VOLTAGE	Reserved
16	FATAL_ERROR_FPGA	HW error in the FPGA setting
17	FATAL_ERROR_MODESET	Reserved
18	FATAL_ERROR_INIT	Application initialization error

## 10.2 Control errors

They are generated by external problems or by the driver power section.

An example of external problem could be the motor overload due to a too heavy mechanical load; an example for the errors due to power section could be the brake resistor overheating.

During the error condition the driver can not be enabled. It is necessary to carry out a specific procedure for the elimination of the error status; there are different procedures, according to the selected controller type.

An irretrievable error can not be cancelled by software procedures. Try to disconnect the auxiliary power supply from the driver and then connect it again. If the error persists, it might be necessary to replace it.

The error code is displayed on the VISIO and on the LEDs, according to the modes specified in chapter [8.3](#).

### 10.2.1 Models for brushless motor

Cod.	Error	Description
01	VRef beyond limits	<b>Irretrievable.</b> The detected value of the reference voltage is beyond the tolerance limits.
02	The currents are not balanced	<b>Irretrievable.</b> The sum of the three-phase currents of the motor are not balanced. The current may be wasted down to earth on the motor side and/or a current sensor module may be damaged.
03		Reserved.
04	NTC driver interrupted	The temperature sensor of the driver is interrupted.
05	NTC motor interrupted	The temperature sensor of the motor is interrupted. Make sure that the encoder cable is connected properly.
06	Motor temperature too high	The motor temperature exceeds the limit set in the parameter [1.4.10]. Make sure that the load applied to the motor is correct (no obstructions, nor frictions). If everything is OK or if you are testing the motor and it has not reached the operating temperature yet, it is recommended to increase the limit or to cool the motor. If these hypotheses are all to be discarded, it is recommended to replace the motor with one of a larger size.
07	Driver temperature too high	The temperature inside the driver is too high. It is recommended to increase the ventilation.
08	Intervention of protection	<b>Irretrievable.</b> This error signals the intervention of the hardware protection inside the power board. Here are the main causes: a) over-current in the output phases b) simultaneous conduction of IGBT c) power supply default on the IGBT Gates d) disturb current impulse There are several causes for these defects, both inside and outside the driver: motor cable, motor turning-up, wrong connections of the earth lines. If the error persists, it will be necessary to replace the driver.
09	Converter I out of limits	This error indicates that the data applied to the motor must be better calibrated or that the application requires too quick current increases which can not be controlled by the driver. While waiting for a more precise calibration of the parameters, please reduce the maximum speed rates and the speed increase fronts. Moreover, make sure that the pre-selected motor is the one actually in use.
10	DC BUS voltage exceeding the maximum limit	This error occurs if the brake resistor can not absorb all power generated by the motor. It can also indicate that the mains voltage is higher than the limits permitted or is considerably fluctuating.

11	Hall sensors code not correct	This error occurs if the motor encoder cable is not connected or if the wiring is not correct. It can also occur in case of break-down of the motor encoder or of the hardware inside the driver.
12		Reserved.
13	Brake resistor temperature too high	The brake resistor temperature exceeds the pre-set limits. The cause might be a too high voltage or an excessive mass applied to the motor shaft.
14	DC BUS voltage too low	The mains voltage is not enough or one of the phases of the main power supply is absent. It is recommended to check the power supply line and the parameter [1.7.2].
15	Corrupted data in EEPROM	This error occurs due to the EEPROM memory damaged. It is possible to restore the factory parameters as described in paragraph 7.3 of this manual.
16	Too high speed	This error occurs when the parameter [1.4.9] is not properly installed or when a too high integrative gain implies an excessive adjustment, which leads the motor out of the limits permitted.
17	SW no longer under control	<b>Irretrievable.</b> The microprocessor does not execute the main programme
18	Torque time limit overtaken	This error occurs when the time set in parameter [1.3.5] is inferior to the time when the motor torque overtakes the pre-set maximum torque value.
19		Reserved.
20		Reserved.
21	Motor voltage different from driver voltage	The rated voltage set for the driver is different from the motor voltage. This problem causes an excessive power supply to the motor windings.
22	Excessive current for disabled driver	<b>Irretrievable.</b> While the driver was disabled, the sensors detected too high current. This problem is due to the hardware bad functioning.
23	Field bus hardware error	<b>Irretrievable.</b> During the HW test on the field bus control section, some errors occurred.
24	Excessive deviation of position	This error occurs when the position control is active and the driver can not position the motor in the required position. This error could be due to an excessive load which can not be controlled or to a position too distant from the present one. The error is not stored in EEPROM in order to avoid saturating the available positions, because the error might be frequent.
25		Reserved.
26	FAULT in the STO circuit	It was not possible to enable the driver due to the fault in the safety circuit. Make sure the mains voltage is supplied to the connector of the safety circuit.
27	No signal of STO enabling	The driver could not be enabled because there were no signals to the safety circuit.
28	Auxiliary voltage out of range	The auxiliary voltage (24VDC) is out of the permitted range (<20.4V or >28V).
29	Ventilation not enough	At least one of the fans is running at insufficient speed. Check if there are any obstructions that prevent the fans from operating correctly.

## 10.2.2 Models for asynchronous motor

Cod.	Error	Description
03	Auxiliary voltage out of range	The auxiliary voltage (24VDC) is out of the permitted range (<20.4V or >28V).
05	NTC motor interrupted	The temperature sensor of the motor is interrupted. Make sure that the encoder cable is connected properly.
06	Motor temperature too high	The motor temperature exceeds the limit set in the parameter [1.4.10]. Make sure that the load applied to the motor is correct (no obstructions, nor frictions). If everything is OK or if you are testing the motor and it has not reached the operating temperature yet, it is recommended to increase the limit or to cool the motor. If these hypotheses are all to be discarded, it is recommended to replace the motor with one of a larger size.
07	Driver temperature too high	The temperature inside the driver is too high. It is recommended to increase the ventilation.
08	Intervention of protection	<b>Irretrievable.</b> This error signals the intervention of the hardware protection inside the power board. Here are the main causes: a) over-current in the output phases b) simultaneous conduction of IGBT c) power supply default on the IGBT Gates d) disturb current impulse There are several causes for these defects, both inside and outside the driver: motor cable, motor turning-up, wrong connections of the earth lines. If the error persists, it will be necessary to replace the driver.
09	Maximum current overtaken	This error indicates that the current supplied to the motor exceeds the maximum value permitted; this value is calculated by choosing the lowest value among the maximum current accepted by the motor and the maximum current accepted by the driver.
10	DC BUS voltage exceeding the maximum limit	This error occurs if the brake resistor can not absorb all power generated by the motor. It can also indicate that the mains voltage is higher than the limits permitted or is considerably fluctuating.
13	Brake resistor temperature too high	The brake resistor temperature exceeds the pre-set limits. The cause might be a too high voltage or an excessive mass applied to the motor shaft.
14	DC BUS voltage too low	The mains voltage is not enough or one of the phases of the main power supply is absent. It is recommended to check the power supply line and the parameter [1.7.2].
15	Corrupted data in EEPROM	This error occurs due to the EEPROM memory damaged. It is possible to restore the factory parameters as described in paragraph 7.3 of this manual.
18	Current limit for time limit overtaken	See description of [1.3.9] in the menu VISIO 3000.
26	Ventilation not enough	At least one of the fans is running at insufficient speed. Check if there are any obstructions that prevent the fans from operating correctly.
27	Diagnostic problem	The inverter was disabled due to some problems in the hardware diagnostic. If the problem persists, it is recommended to replace the device.

28	Mains voltage problem	There are some problems to the three-phase mains voltage, due to the absence of one or more phases and/or lack of voltage. It is recommended to check the correct operation of the power supply protection systems.
29	FAULT in the STO circuit	It was not possible to enable the driver due to the fault in the safety circuit. Make sure the mains voltage is supplied to the connector of the safety circuit.
30	STO circuit enabling	The driver safety circuit has no external consent signals

### 10.3 Warnings

#### 10.3.1 Models for brushless motor

Code	Message	Description
27	Absence of STO enabling signals	It was not possible to enable the driver, due to no consent signals to the safety circuit.

#### 10.3.2 Models for asynchronous motor

Cod.	Message	Description
26	Ventilation not enough	At least one of the fans is running at insufficient speed rate. Check if there are any obstructions that prevent the fans from operating correctly.

## 11 Error codes (SERCOS II model)

The drivers COSMOS 3000 - SERCOS II model feature two series of error codes: the errors due to the driver and the errors due to SERCOS II field bus.

### 11.1 Driver errors

The error code is indicated on the FBS LEDs according to the criteria in chapter 8.3.

As long as the driver is in error condition, it can not be enabled. It is necessary to carry out a specific procedure to cancel the error status; the procedure is different according to the selected controller.

An **irretrievable** error can not be cancelled through software procedures. Try to disconnect the power supply from the driver logic and then connect it again. If the error persists, replace the driver.

Here is a list of the errors:

Code	Error	Description
1	VRef beyond limits	<b>Irretrievable.</b> The detected value of the reference voltage is beyond the tolerance limits.
2	The currents are not balanced	<b>Irretrievable.</b> The sum of the three-phase currents of the motor are not balanced. The current may be wasted down to earth on the motor side and/or a current sensor module may be damaged.
4	NTC driver interrupted	The temperature sensor of the driver is interrupted.
5	NTC motor interrupted	The temperature sensor of the motor is interrupted. Make sure the cable "ENCODER IN" is connected properly.
6	Motor temperature too high	The motor temperature exceeds the limit set in "MOTOR TEMP MAX". Make sure that the load applied to the motor is correct (no obstructions, nor frictions). If everything is OK or if you are testing the motor and it has not reached the operating temperature yet, it is recommended to increase the limit or to cool the motor. If these hypotheses are all to be discarded, it is recommended to replace the motor with one of a larger size.
7	Driver temperature too high	The inner temperature is too high. It is recommended to increase the driver ventilation.
8	Intervention of the protection	<b>Irretrievable.</b> This error signals the intervention of the hardware protection inside the power board. Here are the main causes: a) over-current in the output phases b) simultaneous conduction of IGBT c) power supply default on the IGBT Gates d) disturb current impulse There are several internal/external causes for these defects: motor cable, motor turning-up, wrong connections of the earth lines. If the error persists, it will be necessary to replace the driver.
9	Converter I out of limits	This error indicates that the data applied to the motor must be better calibrated or that the application requires too quick current increases which can not be controlled by the driver. While waiting for a more precise calibration of the parameters, please reduce the maximum speed rates and the speed increase fronts. Moreover, make sure that the pre-selected motor is the one actually in use.



10	DC bus voltage exceeding the maximum limits	This error may occur if the braking resistor can not absorb all power generated by the motor or is interrupted. It can also indicate that the mains voltage is higher than the limits permitted or is considerably fluctuating. If an external brake resistor is not available, make sure there is a jumper to use the internal resistor.
11	Hall sensors code not correct	This error occurs if the motor encoder cable is not connected or if the wiring is not correct. It can also occur in case of break-down of the motor encoder or of the hardware inside the driver.
13	Brake resistor temperature too high	The brake resistor temperature exceeds the pre-set limits. The cause might be a too high voltage or an excessive mass applied to the motor shaft.
14	DC bus voltage too low	The mains voltage is not enough. It is recommended to check the power supply line and the parameter <i>VnomDrv</i> .
15	Corrupted data in EEPROM	It occurs due to EEPROM memory damaged. It is possible to restore the factory parameters as described in paragraph 7.3 of this manual.
16	Too high speed	This error occurs when the parameter <i>VelmotMAX</i> is not properly installed or when a too high integrative gain implies an excessive adjustment, which leads the motor out of the limits permitted.
17	SW non longer under control	<b>Irretrievable.</b> The microprocessor does not execute the main programme.
18	Torque time limit overtaken	This error occurs when the time set in parameter <i>Tclim</i> is inferior to the time when the motor torque overtakes the pre-set maximum torque value.  When the torque level exceeds the pre-set limit (*), a timer is increased. When the torque returns below the maximum level, the timer is decreased. If the timer exceeds the pre-set value (**), an error is signalled. This is a safety function available for the user, in order to protect the application.
21	Motor voltage different from driver voltage	The rated voltage set for the driver is different from the motor voltage. This problem causes an excessive power supply to the motor windings.
22	Excessive current for disabled driver	<b>Irretrievable.</b> While the driver was disabled, the sensors detected too high current. This problem is due to the hardware malfunction.
23	SERCON chip hardware error	<b>Irretrievable.</b> During the HW test on the SERCON chip, some reading/writing errors occurred. The specific error code is indicated in the SERCOS error list. <b>Make sure the SERCOS module has been properly connected.</b>

24	Excessive deviation of position	This error occurs when the position control is active and the driver can not position the motor in the required position. This error could be due to an excessive load which can not be controlled or to a position too distant from the present one. The error is not stored in EEPROM in order to avoid saturating the available positions, because the error might be frequent.
25	I/O disabling	This error occurs when digital I/O are used and an excessive current is required to one or more outputs. It is recommended to check the absorption of the loads applied to the outputs and/or the presence of short-circuits to positive or negative. If the error persists and no conditions beyond limits occur, <b>it will be necessary to replace the driver.</b>

## 11.2 SERCOS errors

### 11.2.1 Error codes

The SERCOS error code is displayed on the FBS LEDs according to the criteria indicated in chapter [8.3](#). Here is a list of the errors.

Code	Description
00 / OK	No error
21	Communication error during the transition from phase 0 to phase 1. It may occur when no address is associated to the device.
22	Communication error during the transition from phase 1 to phase 2.
23 e 24	Communication error during the transition from phase 2 to phase 3.
25	Communication error during the transition from phase 3 to phase 4.
28	Transition to a different phase not allowed.
29	Loss of 2 consecutive MST.
30	Loss of 2 consecutive MDT.
32	Loss of communication (optical signal interruption)
40	SERCON chip not found.
41	SERCON chip version not correct.
42	SERCON chip software reset error.
43	Reading/writing error of the SERCON chip DPRAM.

The codes equal to or higher than 40 refer to **hardware** problems in the control logic of the SERCOS protocol. As a consequence, these errors cause the irretrievable drive error 23.

The remaining codes concern an error condition that occurred during SERCOS **communication**. They do not reveal hardware problems in the driver, but a wrong information exchange with the master, an excessive attenuation of the optical signal or simply a wrong setting of the communication parameters (address, speed, optical power, operating mode...).

Please note that this type of errors takes a lower priority as compared to the "driver errors". In case of simultaneous presence of SERCOS error and driver error, the driver error will be signalled first.

### 11.2.2 Solution of communication problems

This paragraph describes some typical causes generating problems during SERCOS communication and how to discover them.

If you consider the error list (21÷32) in the previous paragraph, you can find the situations listed here below:

#### 11.2.2.1 Errors from 21 to 25

They occur during the phase increase in SERCOS communication SERCOS. In fact, before the system becomes operational, it must be synchronized with the control unit; the synchronization procedure consists of 4 standard phases according to the interface specifications.

**Error 21:** the device *was not addressed* by the control unit. This condition is not necessarily a problem: if you are not going to enable the axis controlled by the driver, you can avoid considering the device. The SERCOS ring will continue working. Otherwise, it is necessary to check the address setting and the controller, as indicated in paragraph "SERCOS interface configuration".

**Error 22:** the device was correctly addressed but it can not change the phase. This may be due to the absence of the address of another device searched by the control unit, which consequently interrupted the communication.

**Error 23:** it may occur at the beginning of phase 2. The system did not initialize the non-cyclic communication (see standard SERCOS). This may be due to the device and/or control unit failure.

**Error 24 and 25 :** transition from phase 2 to phase 3 (24) or from phase 3 to phase 4 (25) was not possible. This is due to wrong exchange of configuration parameters (time, structure of the cyclic message, unsuccessful procedural commands). Check the control unit programme.

#### 11.2.2.2 Errors from 28 to 30

These errors are strictly linked to phase 4, in which the communication is synchronized with the control unit and is fully operational.

**Error 28:** It indicates the control unit's attempt to carry out a phase change that is not allowed. In fact, for the interface specifications, only the transitions to phase 0 are considered as valid.

**Error 29 and 30:** they signal the loss of a part of SERCOS message structure twice in the device. Together with error 32, they identify where the problem occurs inside the ring.

#### 11.2.2.3 Error 32

It can occur at any time during the communication. It indicates an interruption of the light signal transmitted by the optical fibre, due to an excessive attenuation or total absence of the signal. Here are the possible causes:

1. The optical fibre features one or more zones where the bend radius is too narrow;
2. The connection is made by means of fixed or mobile joints which imply high signal losses;
3. The device in previous position inside the ring is not working.

#### 11.2.2.4 Examples of errors

In order to better understand the previous errors, we will make some examples of typical situations that might occur. We will consider a SERCOS ring with 4 devices:

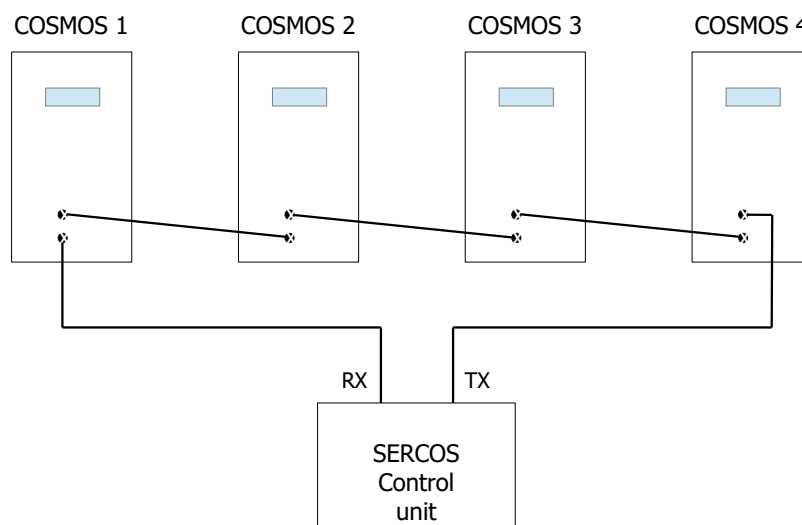

**Example of SERCOS ring**

**EXAMPLE 1:**

<b>COSMOS 1</b>	<b>COSMOS 2</b>	<b>COSMOS 3</b>	<b>COSMOS 4</b>
ERROR 29 or 30	ERROR 29 or 30	ERROR 32	ERROR 32

The problem occurs between *COSMOS 2* and *COSMOS 3*. The control unit is working properly. It is recommended to proceed as follows:

1. Check the optical fibre section between the TX of *COSMOS 2* and the RX of *COSMOS 3*: if possible, check the attenuation applied, reduce too narrow bend radii or replace the optical fibre, if it is damaged.
2. Extract the fibre from the TX of *COSMOS 2* and make sure that the transmitter emits light; otherwise, the driver is damaged and needs to be replaced.
3. If the above problems do not exist, replace the *COSMOS 3*.

This example is valid for an arbitrary number of devices and for all sections of optical fibre.

**EXAMPLE 2:**

<b>COSMOS 1</b>	<b>COSMOS 2</b>	<b>COSMOS 3</b>	<b>COSMOS 4</b>
ERROR 32	ERROR 32	ERROR 32	ERROR 32

The problem occurs between the control unit and the first device in the ring. It is recommended to proceed in the same way as indicated in the previous example.

**EXAMPLE 3:**

<b>COSMOS 1</b>	<b>COSMOS 2</b>	<b>COSMOS 3</b>	<b>COSMOS 4</b>
ERROR 29 or 30	ERROR 29 or 30	ERROR 29 or 30	ERROR 29 or 30

The problem occurs between the last device in the ring and the control unit. Refer to example 1 in order to find the fault.

**EXAMPLE 4:**

<b>COSMOS 1</b>	<b>COSMOS 2</b>	<b>COSMOS 3</b>	<b>COSMOS 4</b>
ERROR 22	ERROR 21	ERROR 22	ERROR 22

The address or the setting of the active controller in the *COSMOS 2* is not correct. Follow the procedure indicated in paragraph [6.2.8.2](#).



The above instructions should not be regarded as an infallible guide. The combinations of the error codes and the problems causing the errors depend on several conditions inherent in a complex communication system such as the SERCOS.

## 12 Firmware update

Further to upgrades or features implementation, COSMOS 3000 servodrives can be updated to a later firmware release. The firmware can be updated from your PC via USB connection.

### 12.1 Update on PC via USB connection

To carry out this operation you need a PC running Windows XP or later OS with a free USB port. Smittec proprietary software Winmicro and the drivers for the USB port of COSMOS-3000 must be already installed. Refer to the instructions included in the installation file.

1. Connect the USB cable (type A->mini-B) - mini-B side – to COSMOS 3000 servodrive; it doesn't need to be switched off.
2. Connect the USB cable – side A – to a free USB port
3. Switch on the COSMOS 3000 servodrive
4. Start Smittec Winmicro software

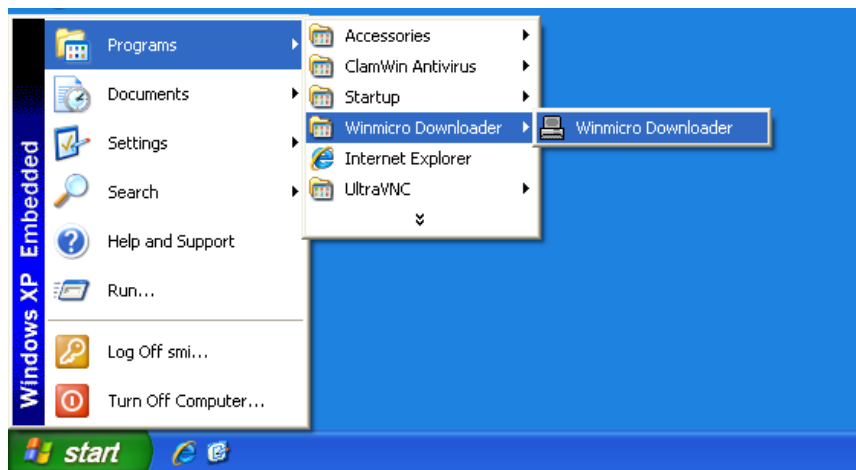

5. Once started, the following window will pop up

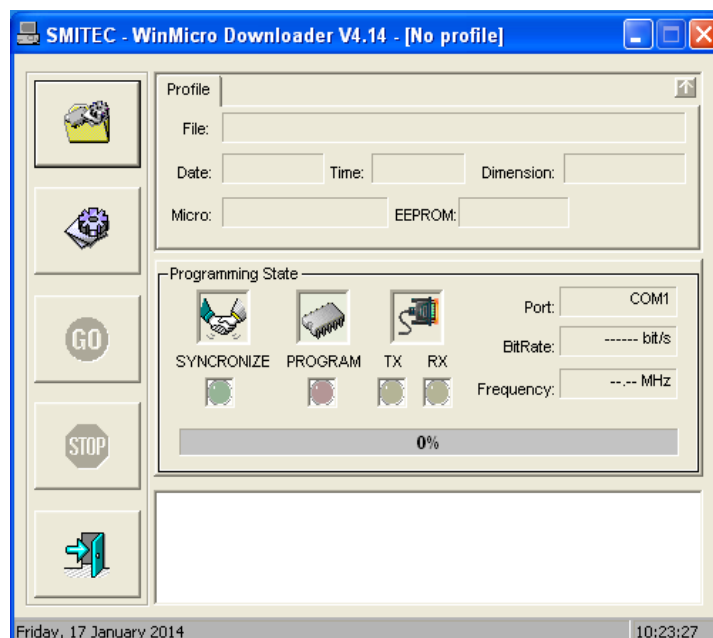

- Open the program menu clicking on the top left icon.

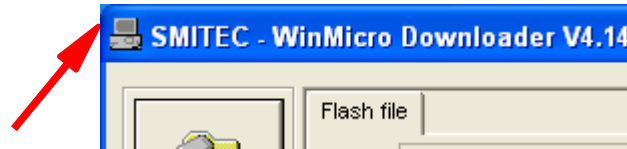

- Unflag the option "Enable Profiler"

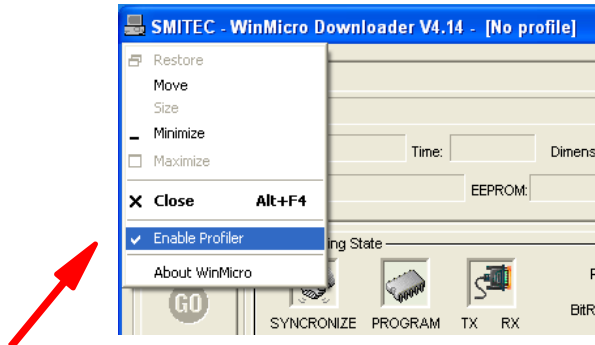

- Click on the "Settings" button



- The Settings window will open: set the serial port number you will use for the programming (the COSMOS 3000 USB port is recognized by Windows as serial port); as a rule it's the higher COM number available.

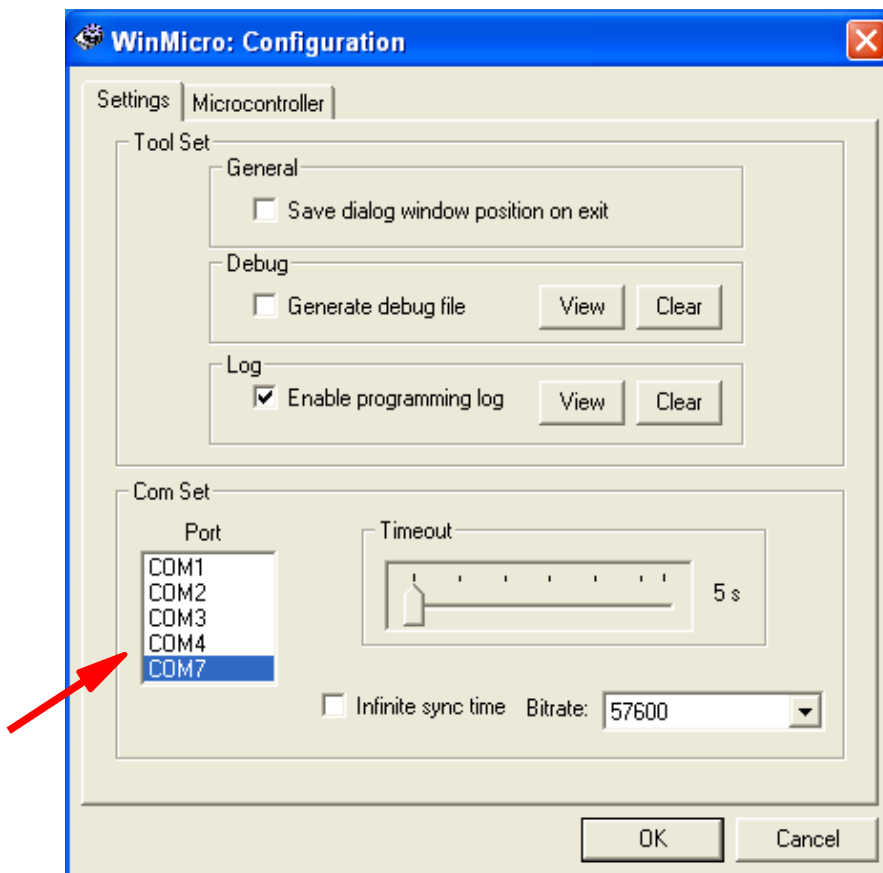

- Switch to Microcontroller window and set the microcontroller type, which in COSMOS 3000 is SH7211F

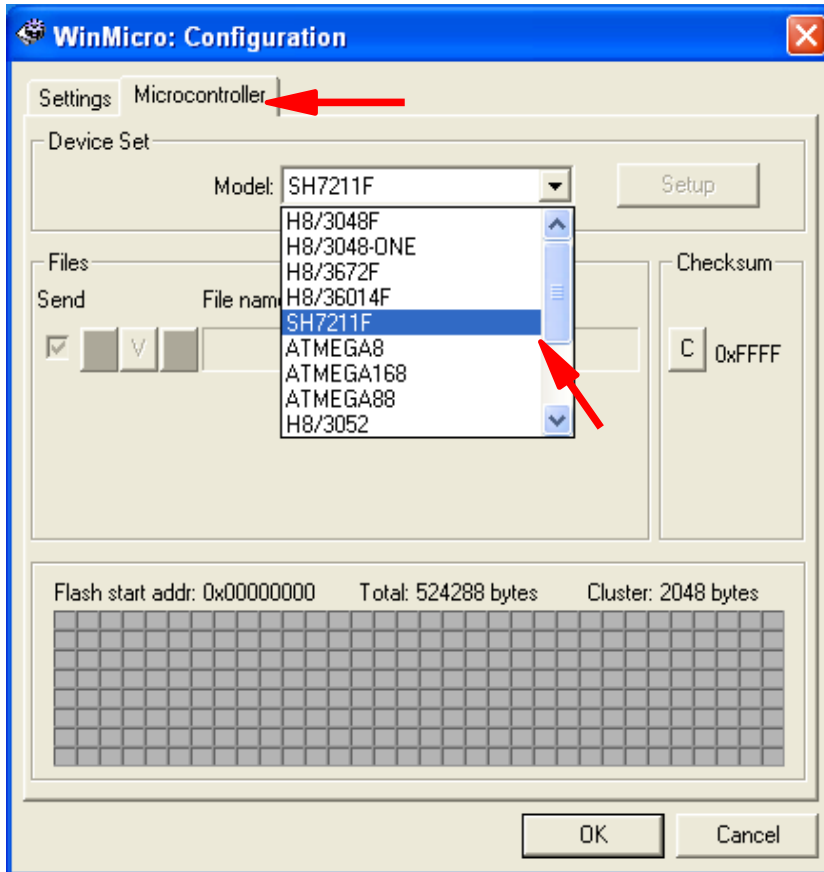

- Click on the OK button
- Click on the button in the main window



- The window for the selection of the file for the firmware update will pop up: make sure you select the correct file

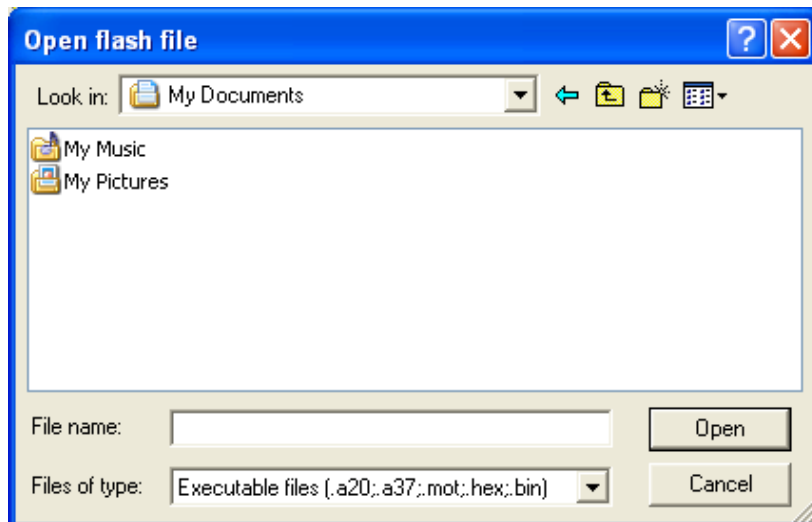

- Once the file has been uploaded, the main Winmicro window will feature some info on the file and on the selected controller; if the COSMOS 3000 is switched on, the USB cable is properly connected to the PC and to the servodrive, and the selected port is correct, the USB symbol will pop up beside the word "Port".

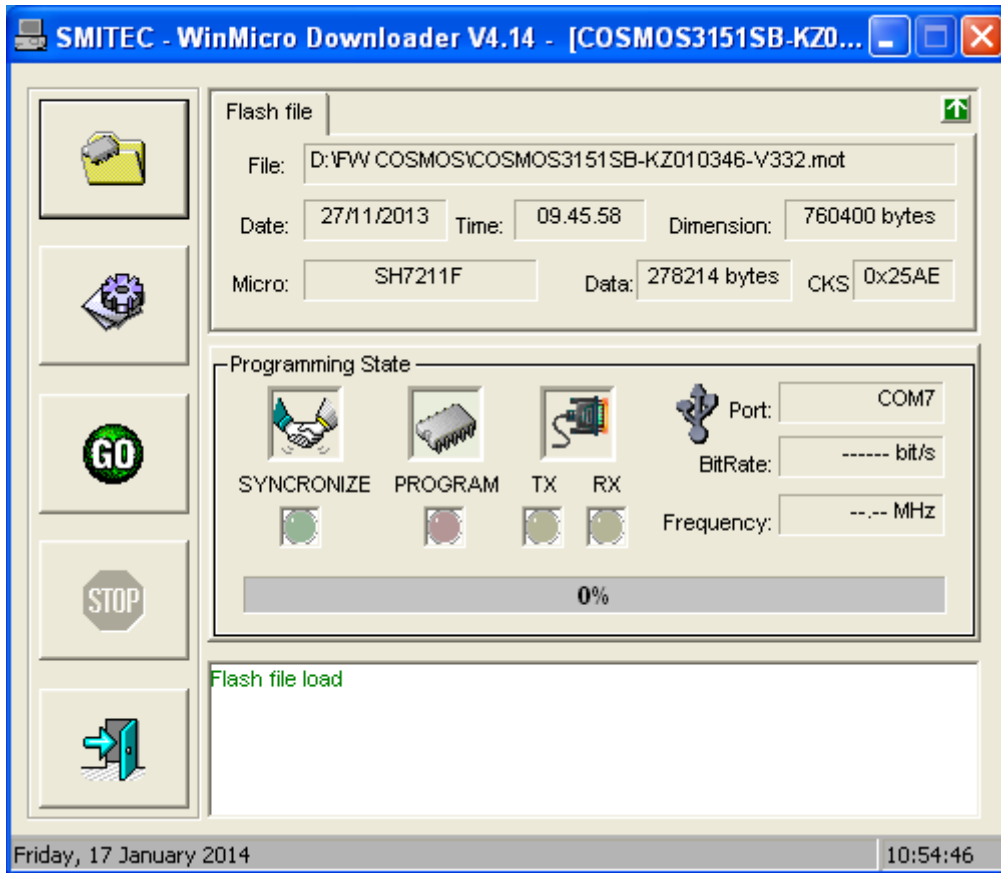

- Click on the GO button to start programming



- During programming, status messages will pop up in the lower window and the progress index will proceed

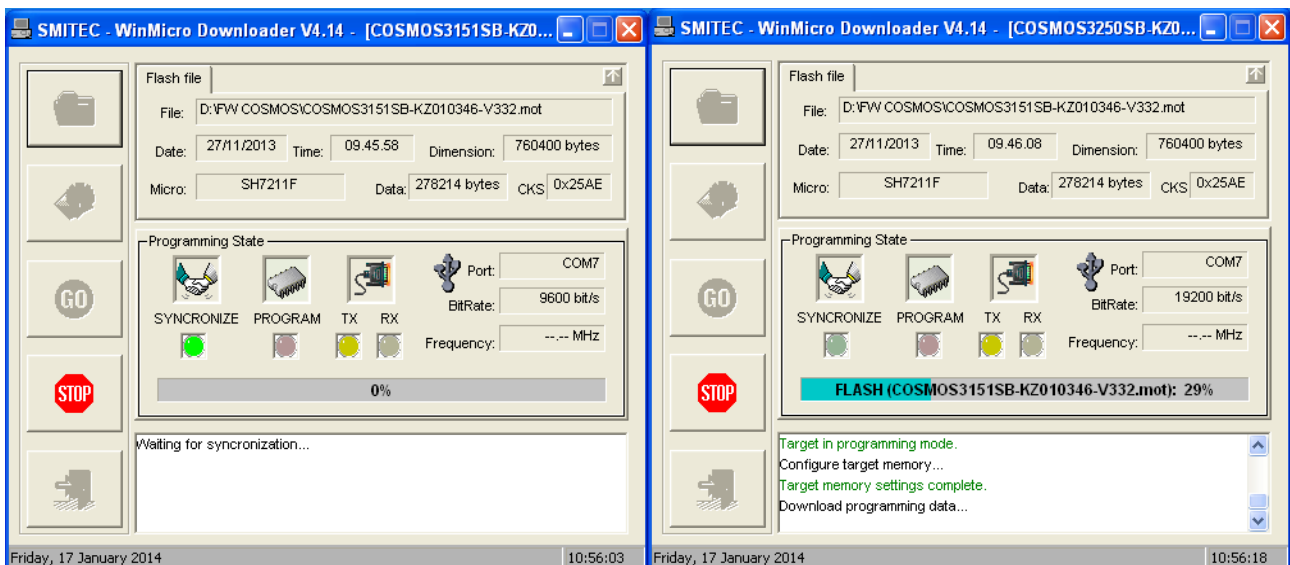



17. At the end of programming the lower window will notify the operation success and the time employed.
18. In case of failure with message "Synchronization Error", make sure that the microcontroller type, the selected file and port number are correct.
19. Once the update has been completed, exit the program by clicking on the following button



## 13 Maintenance



Before performing any type of maintenance, remove power to the device, wait 6 minutes and disconnect all electrical connections.

### 13.1 Replacement of fan blower

#### 13.1.1 COSMOS Type 315X/325X

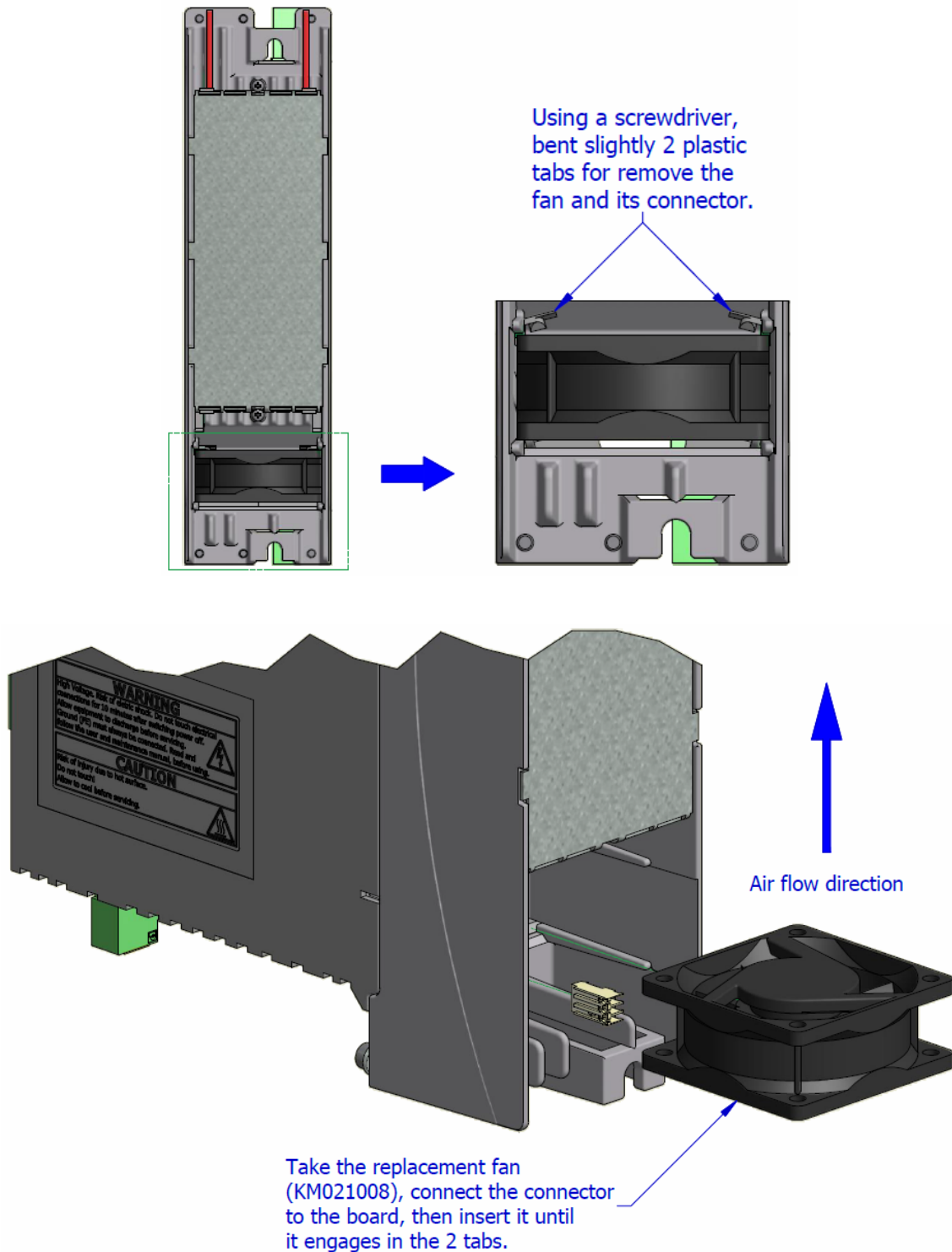

### 13.1.2 COSMOS Type 350X

For safety reasons, the fans are not replaceable by the user.

## 13.2 Replacement of dynamic brake resistor

### 13.2.1 COSMOS Type 325X

- Disconnect the wires of the resistor from BRAKE R/J2 connector
- Unscrew the two screws that hold resistor on the back of the heatsink
- Screw the new resistor KG020098
- Connect the wires of the new resistor in BRAKE R/J2 connector

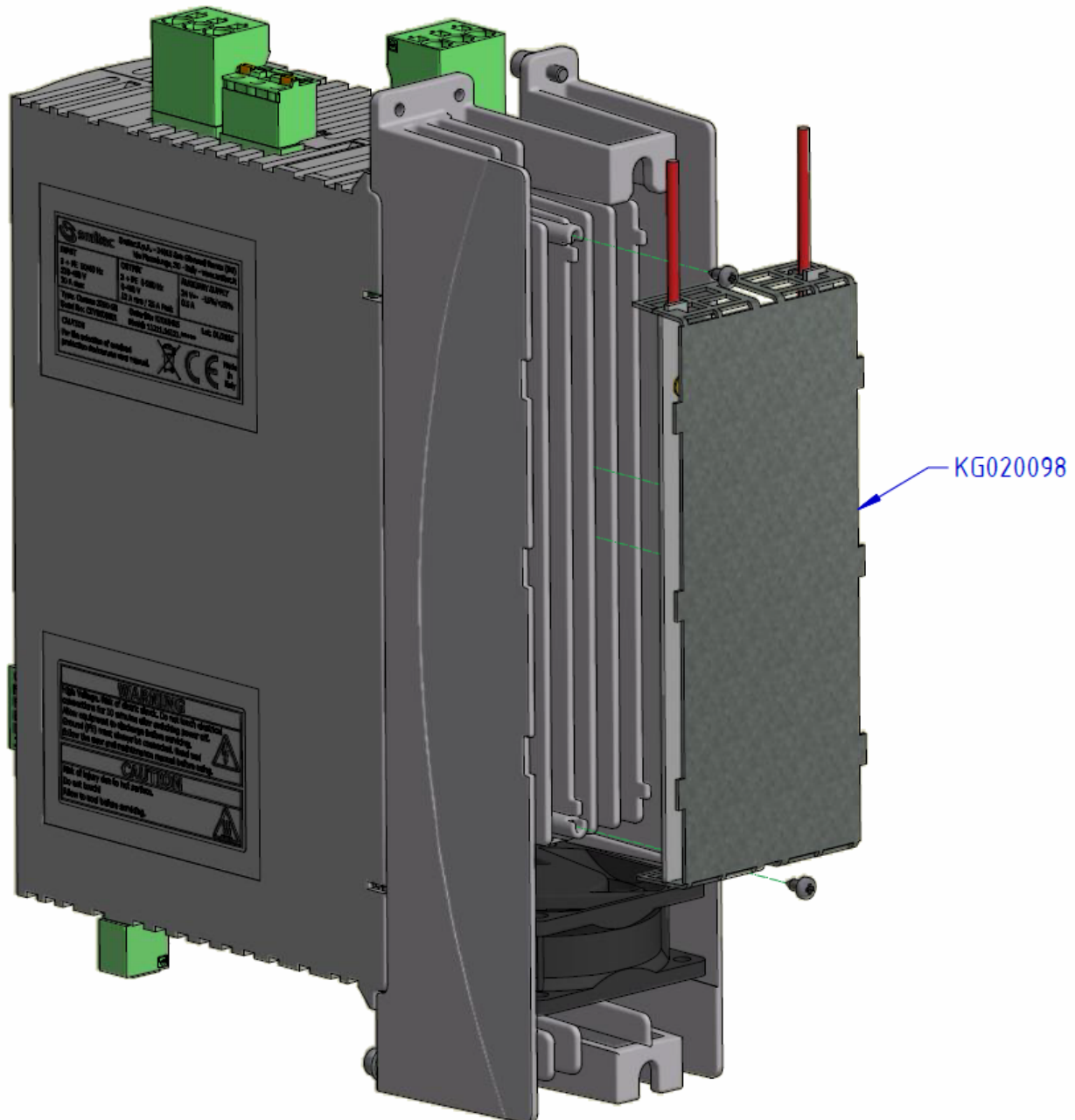

## 14 Appendices

### 14.1 List of settable motors

COSMOS 3000 drives can manage various brushless motors as long as the relative sets of operating parameters are correctly set.

To simplify this operation, COSMOS 3000 drives already have the parameter sets of various motor models stored inside them; these can be recalled via the Visio menu or via remote setup.

The list of selectable motors depends on the firmware version loaded in the drive; below is the list of motors with preset parameters that can be selected according to the firmware version (major firmware versions always include the list of previous versions).

COSMOS 3250-SB	COSMOS 3xxx-FB	COSMOS 3151-SB	COSMOS 3500-SB
FW V 6.13 ↓	FW V 6.03 ↓	FW V 6.13 ↓	FW V 6.13 ↓
EM100146 - 100 8H3	EM100146 - 100 8H3	EM100146 - 100 8H3	EM100146 - 100 8H3
EM100147 - 100 10H2	EM100147 - 100 10H2	EM100147 - 100 10H2	EM100147 - 100 10H2
EM100151 - 100 4H3	EM100151 - 100 4H3	EM100151 - 100 4H3	EM100151 - 100 4H3
EM100152 - 100 8H3	EM100152 - 100 8H3	EM100152 - 100 8H3	EM100152 - 100 8H3
EM100158 - 100 8H3	EM100158 - 100 8H3	EM100158 - 100 8H3	EM100158 - 100 8H3
EM100178 - 100 10H2	EM100178 - 100 10H2	EM100178 - 100 10H2	EM100178 - 100 10H2
FW V 6.00 ↓	FW V 5.11 ↓	FW V 4.00 ↓	FW V 5.00 ↓
B10541P - 296 1200	B10541P - 296 1200	B10541P - 296 1200	B10541P - 296 1200
B10541P - 296 2000	B10541P - 296 2000	B10541P - 296 2000	B10541P - 296 2000
B10661P - 296 1200	B10661P - 296 1200	B10661P - 296 1200	B10661P - 296 1200
B10661P - 296 2000	B10661P - 296 2000	B10661P - 296 2000	B10661P - 296 2000
B5602P - 268 2000	B5602P - 268 2000	B5602P - 268 2000	B5602P - 268 2000
B6304P - 170 3000	B6304P - 170 3000	B6304P - 170 3000	B6304P - 170 3000
B6304P - 296 3000	B6304P - 296 3000	B6304P - 296 3000	B6304P - 296 3000
B6306P - 171 3000	B6306P - 171 3000	B6306P - 171 3000	B6306P - 171 3000
B6306P - 296 3000	B6306P - 296 3000	B6306P - 296 3000	B6306P - 296 3000
B6308P - 170 3000	B6308P - 170 3000	B6308P - 170 3000	B6308P - 170 3000
B6308P - 296 3000	B6308P - 296 3000	B6308P - 296 3000	B6308P - 296 3000
B7108P - 171 3000	B7108P - 171 3000	B7108P - 171 3000	B7108P - 171 3000
B7108P - 296 2000	B7108P - 296 2000	B7108P - 296 2000	B7108P - 296 2000
B7108P - 296 3000	B7108P - 296 3000	B7108P - 296 3000	B7108P - 296 3000
B7116P - 171 3000	B7116P - 171 3000	B7116P - 171 3000	B7116P - 171 3000
B7116P - 296 2000	B7116P - 296 2000	B7116P - 296 2000	B7116P - 296 2000
B7116P01 - 296 3000	B7116P01 - 296 3000	B7116P01 - 296 3000	B7116P01 - 296 3000
B7116P02 - 296 3000	B7116P02 - 296 3000	B7116P02 - 296 3000	B7116P02 - 296 3000
B7120P - 296 2000	B7120P - 296 2000	B7120P - 296 2000	B7120P - 296 2000
B7120P - 296 3000	B7120P - 296 3000	B7120P - 296 3000	B7120P - 296 3000
B7128P - 296 2000	B7128P - 296 2000	B7128P - 296 2000	B7128P - 296 2000
B7128P - 296 3000	B7128P - 296 3000	B7128P - 296 3000	B7128P - 296 3000
EM100070 - 296 3000	EM100070 - 296 3000	EM100070 - 296 3000	EM100070 - 296 3000
EM100071 - 296 2000	EM100071 - 296 2000	EM100071 - 296 2000	EM100071 - 296 2000
EM100072 - 296 2000	EM100072 - 296 2000	EM100072 - 296 2000	EM100072 - 296 2000



<b>COSMOS 3502-DB</b>			
FW V 6.00 ↓			
AB-B5603P - 155 3000			
AB-B5603P - 268 3000			
AB-B6306P - 171 3000			
AB-B6306P - 296 3000			
AB-B6310P - 171 3000			
AB-B6310P - 296 3000			
AB-B7116P - 171 3000			
AB-B7116P - 296 3000			
B10541P - 296 1200			
B10541P - 296 2000			
B10661P - 296 1200			
B10661P - 296 2000			
B5602P - 268 2000			
B6304P - 170 3000			
B6304P - 296 3000			
B6306P - 171 3000			
B6306P - 296 3000			
B6308P - 170 3000			
B6308P - 296 3000			
B7108P - 171 3000			
B7108P - 296 2000			
B7108P - 296 3000			
B7116P - 171 3000			
B7116P - 296 2000			
B7116P01 - 296 3000			
B7116P02 - 296 3000			
B7120P - 296 2000			
B7120P - 296 3000			
B7128P - 296 2000			
B7128P - 296 3000			
EM100070 - 296 3000			
EM100071 - 296 2000			
EM100072 - 296 2000			
EM100073 - 296 2000			
EM100074 - 296 3000			
EM100075 - 296 4500			
EM100076 - 296 3000			
EM100078 - 296 3000			
EM100079 - 296 3000			
EM100080 - 296 3000			
EM100081 - 296 3000			

EM100082 - 296 3000			
EM100083 - 296 2000			
EM100086 - 296 3000			
EM100088 - 296 4500			
EM100094 - 296 2000			
EM100095 - 296 2000			
EM100096 - 296 2000			
EM100097 - 296 3000			
EM100098 - 296 3000			
EM100099 - 296 4500			
EM100100 - 296 2000			
EM100101 - 296 2000			
EM100102 - 296 3000			
EM100103 - 296 3000			
EM100104 - 296 2000			
EM100105 - 296 2000			
EM100106 - 296 2000			
EM100107 - 296 2000			
EM100108 - 296 3000			
EM100109 - 296 3000			
EM100110 - 296 3000			
EM100111 - 296 3000			
EM100125 - 296 2000			
UL503 - 175 3000			
UL503 - 327 3000			
UL505 - 185 3000			
UL505 - 337 3000			
UL508 - 177 3000			
UL508 - 338 3000			
UL708 - 189 3000			
UL708 - 331 3000			
UL714 - 184 3000			
UL714 - 314 3000			
UL714 - 332 3000			