

Smitec S.p.A., via Carlo Ceresa 10, 24015 San Giovanni Bianco (BG), Italy, www.smitec.it



Installation, use and maintenance manual



BEFORE STARTING UP THE SERVOMOTORS ICOS 3210 SERIES, CAREFULLY READ THIS MANUAL AND FOLLOW ALL INSTRUCTIONS, IN ORDER TO ENSURE MAXIMUM SAFETY

SERVOMOTORS WITH INTEGRATED DRIVE ICOS 3210 SERIES



The technical data and the drawings in this manual might have been modified later; always refer to the latest version.

Summary

1 Preface	4
2 General warnings	5
3 Safety instructions	7
3.1 General information	7
3.2 Precautions during handling and assembly	7
3.3 Precautions against risk of Electric Shock	8
3.4 Precautions against hot components	8
3.5 Residual risks	9
3.6 Limitations of use	9
4 Data sheet	10
4.1 Description	10
4.2 Reference documents	11
4.3 Technical data	11
4.3.1 Mechanical features	11
4.3.2 Environmental specifications	14
4.3.3 Power supply	16
4.3.4 Digital inputs	18
4.3.5 Digital outputs	18
4.3.6 Analogue inputs	18
4.4 Configurations / order codes	18
4.5 Accessories	19
4.6 Electromagnetic compatibility (EMC)	19
4.7 Mechanical specifications	20
4.7.1 Weight	20
4.7.2 Overall dimensions for models without engine brake	20
4.7.3 Overall dimensions models equipped with engine brake	21
4.8 Holding brake	22
4.8.1 Description	22
4.8.2 Features	22
4.8.3 Warnings on the use of the brake	23
4.8.4 Connector view	24
5 Installation and start-up	25
5.1 Preliminary operations	25
5.2 Installation mode	26
5.3 Mechanical assembly	27
5.3.1 Fastening	27
5.3.2 Torque transmission	28
5.4 Connections and LEDs	29
5.4.1 DC power supply - J1	30
5.4.1.1 Conductors and protective devices	33
5.4.1.1.1 Protection for UL applications	33
5.4.1.1.2 Protection for other applications	33
5.4.2 Field bus - J4 and J5	35
5.4.3 Auxiliary power supply 24V - J6	37
5.4.4 I/O - J7	39
5.4.4.1 24V digital inputs	40
5.4.4.2 24V digital outputs	41
5.4.4.3 Analogue input 4÷20mA	42
5.4.5 LEDs	43
5.4.5.1 References signaling LEDs (STS)	43
5.4.5.2 LED1 behavior	44
5.4.5.3 LED2 and LED3 behavior	44
5.4.6 Installation criteria for UL certification	45
5.5 Addressing	46

5.5.1 Manual addressing	46
5.5.2 Automatic addressing	47
6 Firmware upgrade	48
7 Storage	49
8 Maintenance	50
9 Disposal and demolition	51
10 Analytical index	52

1 Preface

This manual provides all necessary information for the installation, use and maintenance of the servodrives ICOS 3210.

The instructions included in this manual are addressed to the following professionals:

User	User is a person, a company or an institution that buys the equipment and uses it for the purposes it was designed for.
User/operator	User or operator is a person authorized by the user to operate on the equipment.
Specialized personnel	It refers to all persons with specific competence, able to recognize and avoid the dangers deriving from the use of the equipment.

The present instructions must be made available to all the above individuals.





2 General warnings



These assembly instructions are an integral part of the equipment, and must be kept for future reference until it decommissioned.

The user should be informed that the present instructions reflect the state of the art at the moment when the equipment was sold; they will remain fully acceptable despite subsequent upgrades based on new technical update.

	<p>DO NOT USE THE EQUIPMENT, NOR MAKE ANY INTERVENTION BEFORE INTEGRALLY READING AND UNDERSTANDING THIS MANUAL.</p>
<p>IN PARTICULAR, ADOPT ALL SAFETY PRECAUTIONS AND PRESCRIPTIONS INDICATED IN THIS MANUAL.</p>	
<p>THE EQUIPMENT MUST NOT BE USED FOR PURPOSES DIFFERENT THAN THE ONES DESCRIBED IN THIS MANUAL; SMITEC S.p.A. SHALL NOT BE HELD RESPONSIBLE FOR ANY DAMAGES, INCONVENIENCES OR ACCIDENTS DUE TO THE NON-COMPLIANCE WITH THESE PRESCRIPTIONS.</p>	

In order to make the manual consultation easier, the following symbols have been adopted:

	<p>Indication of "PROHIBITED ACTION".</p>
	<p>The symbol "DANGER" is used when non-compliance with the prescriptions or misuse may cause serious injuries.</p>
	<p>The symbol "DANGER FROM HOT SURFACES" is used when non-compliance with the prescriptions or misuse may cause serious injuries.</p>
	<p>The symbol "DANGER FROM ELECTRICAL SHOCK" is used when non-compliance with the prescriptions or misuse may cause serious injuries.</p>



	The symbol "USE OF INDIVIDUAL PROTECTIONS" means that protective gloves must be worn.
	The symbol "USE OF INDIVIDUAL PROTECTIONS" means that protective glasses must be worn.
	Indication of "INFORMATION OF PARTICULAR RELEVANCE".

The safety prescriptions aim at establishing a series of behaviors and obligations to be complied with, while performing the activities described later on in this manual.



These prescriptions constitute the prescribed method of operating the device, in a way that is safe for personnel, equipments and environment.

3 Safety instructions

3.1 General information

	<p>Do not install or use the equipment before integrally reading and understanding this manual. In case of difficulties of interpretation, contact SMITEC technical service.</p> <p>It is absolutely forbidden to use the equipment for different purposes than the ones described in this manual. The technical data and the drawings in this manual might have been modified later; always refer to the latest version. All upgrades can be requested to SMITEC S.p.A. directly.</p>
	<p>Make sure that the personnel is qualified and adequately informed about the risks he may run and how to avoid them.</p>
	<p>Servodrives ICOS 3210 can be used only after classifying the final machine operating zone and after checking the safety levels, which must comply with the machine safety levels.</p>

3.2 Precautions during handling and assembly

	<p>Use adequate tools during the assembly, in order to avoid crushing or abrasions.</p>
	<p>Metal components and sharp surfaces may cause cuts and tears. In case of contact, be very careful and wear the personal protection equipment.</p>

3.3 Precautions against risk of Electric Shock

	<p>The power supply connector is subject to high voltage during the servodrive operation; be careful (danger of Electric Shock).</p>
	<p>During installation and maintenance, disconnect the device from the mains power supply. Risk of Electric Shock.</p>
	<p>Some components (such as the aluminium heat sink) are made of conductive materials. They must be safely connected to the protective conductor (PE/Ground) by using the specific terminal strips, in order to avoid Electric Shock.</p>
	<p>Never use the device if it is partially or totally disassembled. Risk of Electric Shock and/or damages to people and properties.</p>

3.4 Precautions against hot components

WARNING

	<p>The parts of the apparatus can reach an extremely high temperature in operating mode or post-operation; take particular care not to touch the parts of the equipment in these cases, or use special protections and precautions during handling: Hot Surface, Risk of Burn.</p>
---	--

AVERTISSEMENT

	<p>Les pièces de l'appareil peuvent atteindre une température extrêmement élevée en mode de fonctionnement ou post-opération; veuillez particulièrement à ne pas toucher les pièces de l'équipement dans ces cas, ou utilisez des protections et des précautions spéciales lors de la manipulation: Surface Chaude, Risque de Brûlure.</p>
---	--

	<p>The manufacturer of a servodrive ICOS 3210 must take all precautions in order to avoid the operator's contact with hot components, to prevent the risk of burning.</p>
---	---

3.5 Residual risks

	<p>The apparatus generates an electromagnetic field during operation. Danger for people with pacemakers, metal prostheses or hearing aids.</p>
---	--

3.6 Limitations of use

	<p>The servodrives ICOS 3210 are not safety devices; do not rely on them to carry out safety functions (for example: safe stop, safe reduced speed, etc...).</p>
	<p>The operating temperature range of the servodrive is 0 ÷ 55°C; the operating temperature range at rated current (without derating) is 0 ÷ 45°C.</p>

4 Data sheet

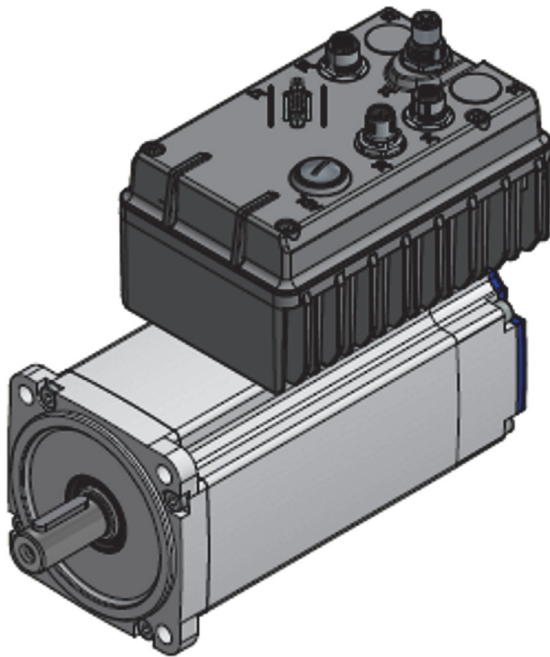

Front view

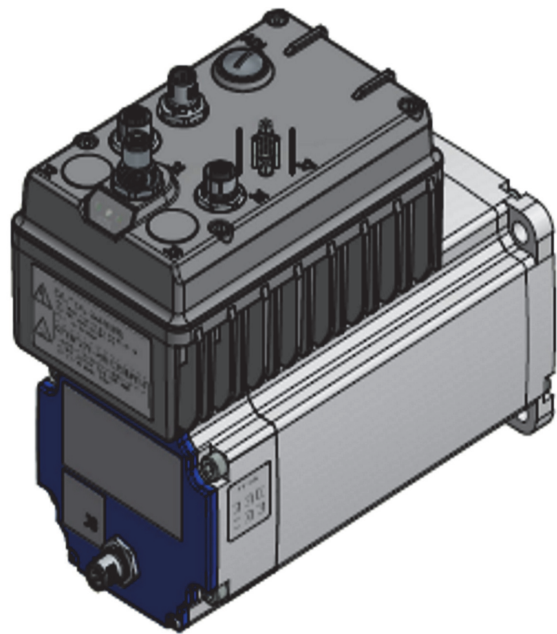

Rear view (model with brake)

4.1 Description

The servomotors ICOS 3210 are brushless AC servomotors (BLAC) with integrated servodrive. The aluminium case enables heat dissipation without needing external fans (“fanless”), forming an extremely compact and reliable unit.

The group includes several models (with different torque, different speed, different overall size, etc...) to better fit different applications.

The motor can be equipped with two different types of encoders: both incremental and absolute; the latter, for safe retention of the position even in the absence of power, can in turn be single-turn or multi-turn.

The control unit, based on a microprocessor, controls an intelligent IGBT module (IPM), in order to ensure a sophisticated, reliable control of the motor. This is possible also thanks to the FixIO field bus, based on insulated, real-time RS 485 serial port. It is possible to check the speed, the position and the motor torque, in a very flexible way. It is possible to upgrade the firmware via field bus, in a quick way and without needing external connections. The field bus insulation ensures better immunity to EMC interferences and improves electrical ruggedness. The 32-bit microcontroller ensures a detailed diagnosis of the device, which is very useful during the system development phase.

In order to grant maximum flexibility, the servodrives ICOS 3210 are equipped with several analogue/digital I/O, to interface with standard sensors and actuators.

4.2 Reference documents

Code	Description
DK400197	Use and programming manual ICOS 32XX
DK400076	FLXIO / FLXMOD integration manual

4.3 Technical data

4.3.1 Mechanical features

		Rated torque	Inrush torque
		EM700031	4.0 Nm
Delivered torque	EM700032	4.0 Nm	12.1 Nm
	EM700033	4.0 Nm	12.1 Nm
	EM700034	6.0 Nm	18.21 Nm
	EM700035	6.0 Nm	12.5 Nm
	EM700036	6.0 Nm	12.5 Nm
	EM700037	6.0 Nm	18.21Nm
	EM700038	6.0 Nm	12.5 Nm
	EM700039	4.0 Nm	12.1 Nm
	EM700040	6.0 Nm	12.5 Nm
	EM700041	6.0 Nm	18.21 Nm
	EM700042	6.0 Nm	18.21 Nm
	EM700047	6.0 Nm	12.5 Nm

Rotation speed		Rated speed	Maximum speed
	EM700031	3000 rpm	3500 rpm
	EM700032	3000 rpm	3500 rpm
	EM700033	3000 rpm	3500 rpm
	EM700034	2000 rpm	2250 rpm
	EM700035	3000rpm	3500 rpm
	EM700036	3000 rpm	3500 rpm
	EM700037	2000 rpm	2250 rpm
	EM700038	3000 rpm	3500 rpm
	EM700039	3000 rpm	3500 rpm
	EM700040	3000 rpm	3500 rpm
	EM700041	2000 rpm	2250 rpm
	EM700042	2000 rpm	2250 rpm
EM700047	3000rpm	3500 rpm	

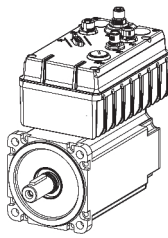
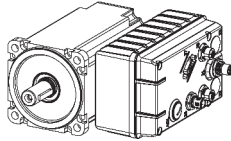
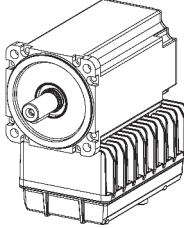
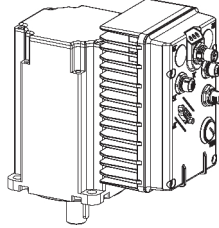
<p>Mechanical power supplied to the shaft (it depends on the assembly position, as indicated in the pictures A, B, C and D)</p>	<p>A</p> 					
			<p>B</p> 			
			<p>C</p> 			
			<p>D</p> 			
			A (kW)	B (kW)	C (kW)	D (kW)
	EM700031	0.77	1.10	0.94	0.84	
	EM700032	0.77	1.10	0.94	0.84	
	EM700033	0.77	1.10	0.94	0.84	
	EM700034	0.91	1.14	0.90	0.77	
	EM700035	0.89	1.27	0.95	0.79	
	EM700036	0.89	1.27	0.95	0.79	
	EM700037	0.91	1.14	0.90	0.77	
	EM700038	0.89	1.27	0.95	0.79	
	EM700039	0.77	1.10	0.94	0.84	
EM700040	0.89	1.27	0.95	0.79		
EM700041	0.91	1.14	0.90	0.77		
EM700042	0.91	1.14	0.90	0.77		
EM700047	0.89	1.27	0.95	0.79		

Rotor moment of inertia	EM700031	$3.48 \cdot 10^{-4} \text{ kg} \cdot \text{m}^2$
	EM700032	$5.82 \cdot 10^{-4} \text{ kg} \cdot \text{m}^2$
	EM700033	$3.48 \cdot 10^{-4} \text{ kg} \cdot \text{m}^2$
	EM700034	$5.01 \cdot 10^{-4} \text{ kg} \cdot \text{m}^2$
	EM700035	$5.01 \cdot 10^{-4} \text{ kg} \cdot \text{m}^2$
	EM700036	$7.36 \cdot 10^{-4} \text{ kg} \cdot \text{m}^2$
	EM700037	$5.01 \cdot 10^{-4} \text{ kg} \cdot \text{m}^2$
	EM700038	$5.01 \cdot 10^{-4} \text{ kg} \cdot \text{m}^2$
	EM700039	$5.82 \cdot 10^{-4} \text{ kg} \cdot \text{m}^2$
	EM700040	$7.36 \cdot 10^{-4} \text{ kg} \cdot \text{m}^2$
	EM700041	$7.36 \cdot 10^{-4} \text{ kg} \cdot \text{m}^2$
	EM700042	$7.36 \cdot 10^{-4} \text{ kg} \cdot \text{m}^2$
	EM700047	$5.01 \cdot 10^{-4} \text{ kg} \cdot \text{m}^2$
Shaft diameter (extendable for all models of the ICOS-FB family)	19 mm	

4.3.2 Environmental specifications

Operating temperature (Maximum air temperature)	$0^\circ \div +45^\circ\text{C}$ with full-load operation
	$0^\circ \div +55^\circ\text{C}$ with derating of the delivered torque
Environment of use	Use in Pollution degree 2 Environment
Degree of protection	IP65

Derating of the delivered torque as compared to the rated torque as a function of the environment temperature for motors EM700031, EM700032, EM700033 and EM700039.

The possible assembly positions, previously described at paragraph 4.3.1 (Mechanical features) are indicated in the legend of the picture.

Derating torque delivered with respect to the nominal value [%]

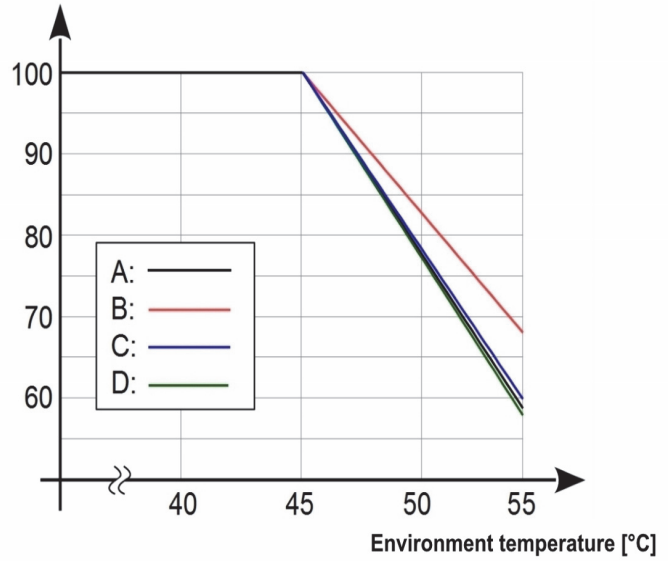

Derating of the delivered torque as compared to the rated torque as a function of the environment temperature for motors EM700035, EM700036, EM700038, EM700040 and EM700047.

The possible assembly positions, previously described at paragraph 4.3.1 (Mechanical features) are indicated in the legend of the picture.

Derating torque delivered with respect to the nominal value [%]

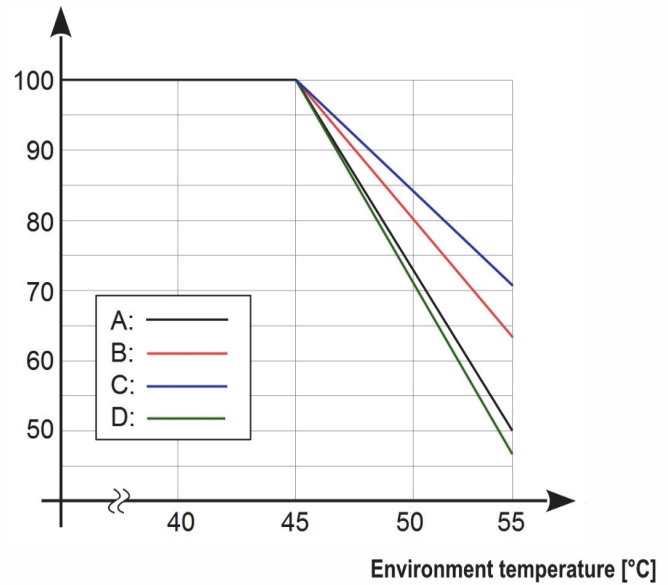

<p>Derating of the delivered torque as compared to the rated torque as a function of the environment temperature for motors EM700034, EM700037, EM700041 and EM700042.</p> <p>The possible assembly positions, previously described at paragraph 4.3.1 (Mechanical features) are indicated in the legend of the picture.</p>	<p>Derating torque delivered with respect to the nominal value [%]</p> <table border="1"> <caption>Derating torque data from graph</caption> <thead> <tr> <th>Environment temperature [°C]</th> <th>A [%]</th> <th>B [%]</th> <th>C [%]</th> <th>D [%]</th> </tr> </thead> <tbody> <tr> <td>45</td> <td>100</td> <td>100</td> <td>100</td> <td>100</td> </tr> <tr> <td>55</td> <td>70</td> <td>75</td> <td>85</td> <td>80</td> </tr> </tbody> </table>	Environment temperature [°C]	A [%]	B [%]	C [%]	D [%]	45	100	100	100	100	55	70	75	85	80
Environment temperature [°C]	A [%]	B [%]	C [%]	D [%]												
45	100	100	100	100												
55	70	75	85	80												
<p>Air humidity during operation</p>	<p>5 ÷ 85% not condensing</p>															
<p>Storage temperature</p>	<p>-25 ÷ +55°C</p>															
<p>Air humidity during stocking</p>	<p>5 ÷ 95%</p>															
<p>Air humidity during transportation</p>	<p>5 ÷ 95%</p>															
<p>Maximum altitude</p>	<p>1000 m a.s.l. at rated output current 2000 m a.s.l. with current derating</p>															
<p>Output current derating as a function of altitude</p>	<table border="1"> <caption>Output current derating data from graph</caption> <thead> <tr> <th>Altitude h [m]</th> <th>I_{out} [%]</th> </tr> </thead> <tbody> <tr> <td>0</td> <td>100</td> </tr> <tr> <td>1000</td> <td>100</td> </tr> <tr> <td>4000</td> <td>70</td> </tr> </tbody> </table>	Altitude h [m]	I _{out} [%]	0	100	1000	100	4000	70							
Altitude h [m]	I _{out} [%]															
0	100															
1000	100															
4000	70															

4.3.3 Power supply

<p>Mains voltage</p>	<p>325 VDC ± 15%</p>
<p>Maximum short-circuit current</p>	<p>5 kA at the installation point</p>

Mains power supply max. absorption	EM700031	3.6A DC
	EM700032	3.6A DC
	EM700033	3.6A DC
	EM700034	3.9A DC
	EM700035	4.1A DC
	EM700036	4.1A DC
	EM700037	3.9A DC
	EM700038	4.1A DC
	EM700039	3.6A DC
	EM700040	4.1A DC
	EM700041	3.9A DC
	EM700042	3.9A DC
	EM700047	4.1A DC
Auxiliary mains voltage	24 VDC -15 ÷ +20%; ripple max 5% of the rated value	
Auxiliary mains power supply max. absorption (references par. 5.4.3)	24V_MAIN	165 mA
	24V_I/O	Current 1.0 A max (digital outputs + Vs)

4.3.4 Digital inputs

Number of inputs	6 inputs: 2 digital inputs and 4 inputs/outputs (I/O)
Number of inputs (only for EM700047)	2 digital inputs
Type	24 V digital inputs, compatible with type 1 and type 3, according to IEC 61131-2
Input sampling interval	1 ms min

4.3.5 Digital outputs

Number of outputs	4 inputs/outputs (I/O)
Number of outputs (only for EM700047)	4 digital outputs
Type	24 V digital outputs - current-sourcing pnp type
Deliverable current on single output	700 mA
Total deliverable current	1 A
Protections	Short-circuit, overload and overtemperature. This protection is self-resetting.
Max frequency of output upgrade	1 kHz

4.3.6 Analogue inputs

Number of inputs	1
Type	4 ÷ 20 mA analogue input
Input current range	4 ÷ 20 mA DC
Resolution	12 bit

4.4 Configurations / order codes

Up to date we defined some standard configurations of servodrives, with an order code and a number made of 4 figures and 2 letters, called "Type", indicating the series, the maximum current, the hardware version, the communication bus and the controlled motors. The type is indicated on the servodrive label.

Order code	Model	Description
EM700031	ICOS 3210-FB-	Ø95 4Nm 230V 3000rpm single turn encoder
EM700032	ICOS 3210-FB-	Ø95 4Nm 230V 3000rpm single turn encoder with integrated motor brake

EM700033	ICOS 3210-FB-	Ø95 4 Nm 230V 3000 rpm multi turn encoder
EM700034	ICOS 3210-FB-	Ø95 6 Nm 230V 2000 rpm single turn encoder
EM700035	ICOS 3210-FB-	Ø95 6Nm 230V 3000rpm single turn encoder
EM700036	ICOS 3210-FB-	Ø95 6Nm 230V 3000rpm single turn encoder with integrated motor brake
EM700037	ICOS 3210-FB-	Ø95 6Nm 230V 2000rpm multi turn encoder
EM700038	ICOS 3210-FB-	Ø95 6Nm 230V 3000rpm multi turn encoder
EM700039	ICOS 3210-FB-	Ø95 4Nm 230V 3000rpm multi turn encoder with integrated motor brake
EM700040	ICOS 3210-FB-	Ø95 6Nm 230V 3000rpm multi turn encoder with integrated motor brake
EM700041	ICOS 3210-FB-	Ø95 6Nm 230V 2000rpm single turn encoder with integrated motor brake
EM700042	ICOS 3210-FB-	Ø95 6Nm 230V 2000rpm multi turn encoder with integrated motor brake
EM700047	ICOS 3210-FB-	Ø95 6Nm 230V 3000rpm single turn encoder

4.5 Accessories

The following table lists the accessories of the servodrives ICOS 3210 series, including their order code:

Order code	Item
KZ010451	DC bus power supply unit ICOS-PS 3161
EP200328	Push-pull connector for the main power supply
KF131326	Connector with termination resistor for FlxIO bus, type M12

4.6 Electromagnetic compatibility (EMC)

The servodrives/inverters comply with EN IEC 61800-3 requirements for installation in environment 2 (“*Second environment*”), category C3. The servodrive must be installed according to the installation criteria described in the manual of the power supply unit ICOS-PS 31XX. The manual code is DK400183.

The servodrive installation can be considered as adequate when it complies with the installation criteria of its power supply unit (ICOS-PS) and no more than six servodrives (ICOS) are installed downstream.

The installer shall make sure that the device meets the standard requirements (EN IEC 61800-3 for the installation in environment 2 “*Second environment*”, category C3).

4.7 Mechanical specifications

4.7.1 Weight

The following table indicates the weight of the different models:

TYPE	Weight (kg)
EM700031 and EM700033	5.5 kg
EM700032 and EM700039	6.4 kg
EM700034, EM700035, EM700037, EM700038 and EM700047	6.6 kg
EM700036, EM700040, EM700041 and EM700042	7.5 kg

4.7.2 Overall dimensions for models without engine brake

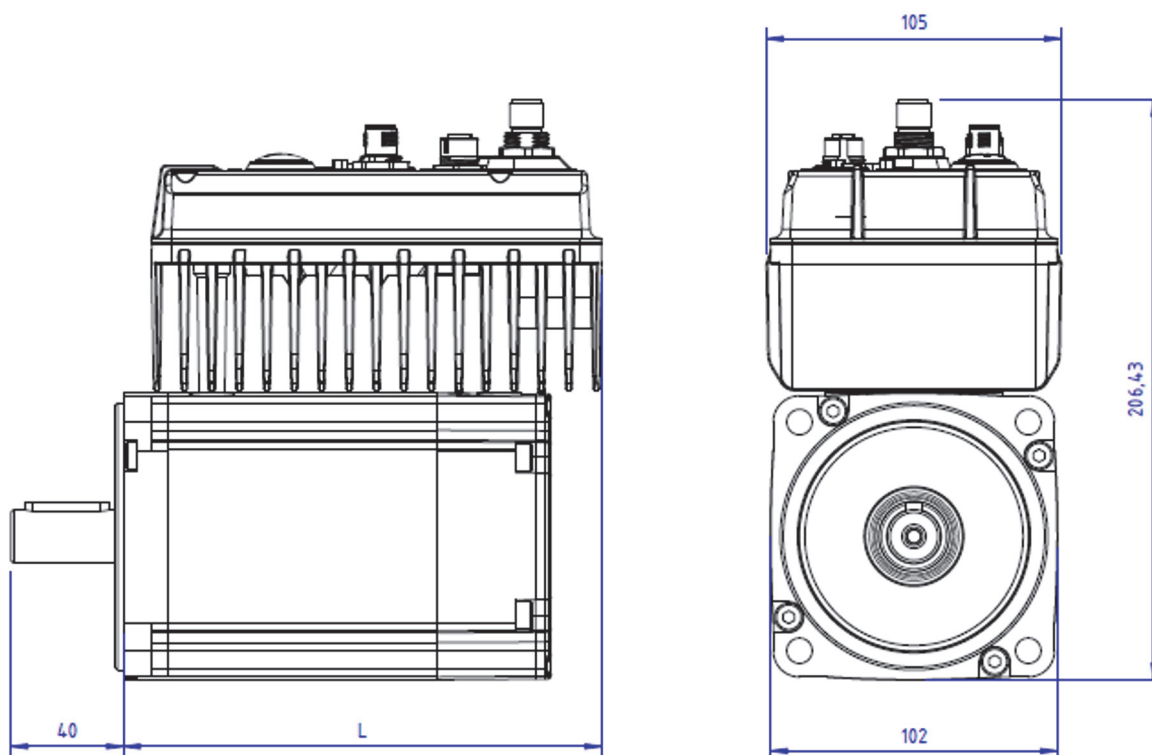

Below is a summary table of the length (L) expressed in millimetres (mm) of the various ICOS 3210-FB models without engine brake:

SMITEC code	Length (L)
EM700031 and EM700033	170 mm
EM700034, EM700035, EM700037, EM700038 and EM700047	192 mm

4.7.3 Overall dimensions models equipped with engine brake

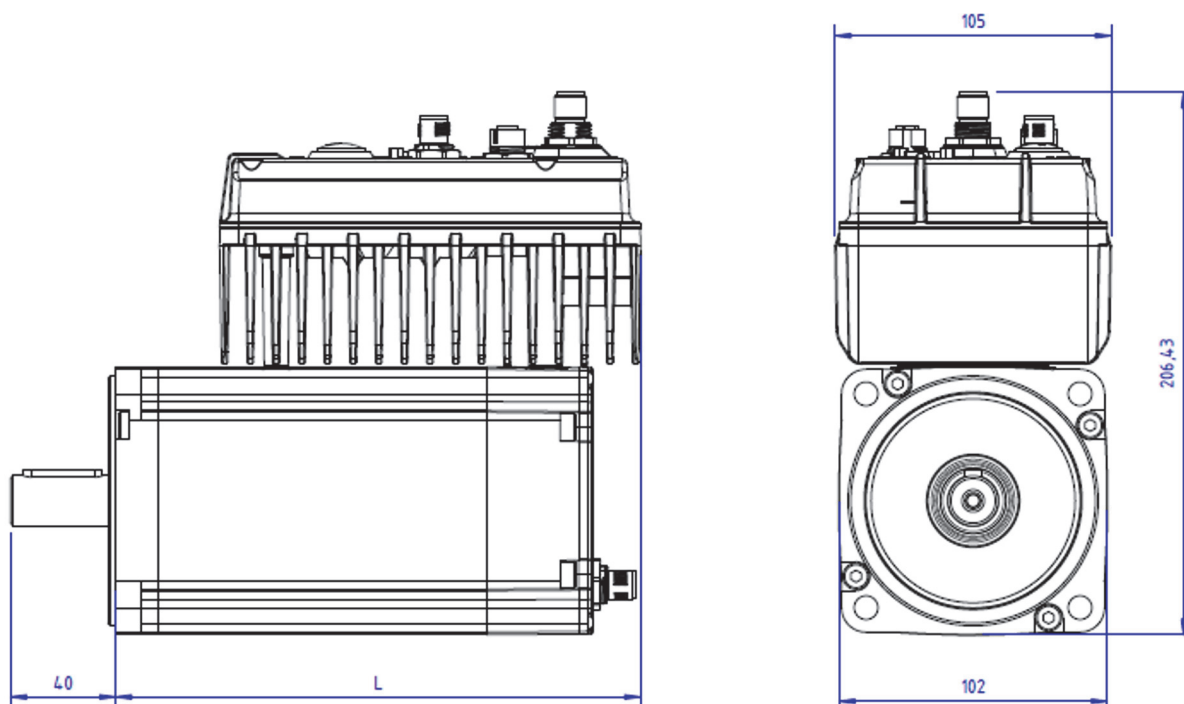

Below is a summary table of the length (L) expressed in millimetres (mm) of the various ICOS 3210-FB models equipped with engine brake:

SMITEC code	Length (L)
EM700032 and EM700039	199,5 mm
EM700036, EM700040, EM700041 and EM700042	221,5 mm

4.8 Holding brake

4.8.1 Description

The holding brake is totally integrated in the motor. This is an electromagnetic brake and needs 24Vdc power supply. On ICOS devices, the motor is free to run if the brake is powered; by contrast, the brake stops the motor if it is not powered with 24Vdc voltage.

4.8.2 Features

Power supply voltage	24 Vdc +/- 10%
Power consumption	18.0 W
Current consumption	0.75 A DC
Nominal braking torque @ 20°C	9 Nm
Nominal braking torque @ 100°C	8 Nm
Stopping time (from interruption of the 24Vdc power supply to reaching the rated value of the braking torque)	7 ms
Insertion delay time (from the interruption of the 24Vdc power supply up to the initial increase in the nominal value of the braking torque)	2 ms
Release delay time (from the insertion of the 24Vdc power supply voltage up to the initial decrease in the nominal value of the braking torque)	40 ms

4.8.3 Warnings on the use of the brake

	<p>Do not start the motor while the brake is applied. Risk of damaging the motor and the brake.</p>
	<p>The servodrive can supply a higher torque than the brake resisting torque. To stop the motor in a safe way, disable the servodrive simultaneously to the brake activation.</p>
	<p>To ensure a safe stop of the motor, make sure that the torque on the rotor is lower than the brake resisting torque. Risk of uncontrolled behaviour with possible damages to people and properties.</p>

4.8.4 Connector view

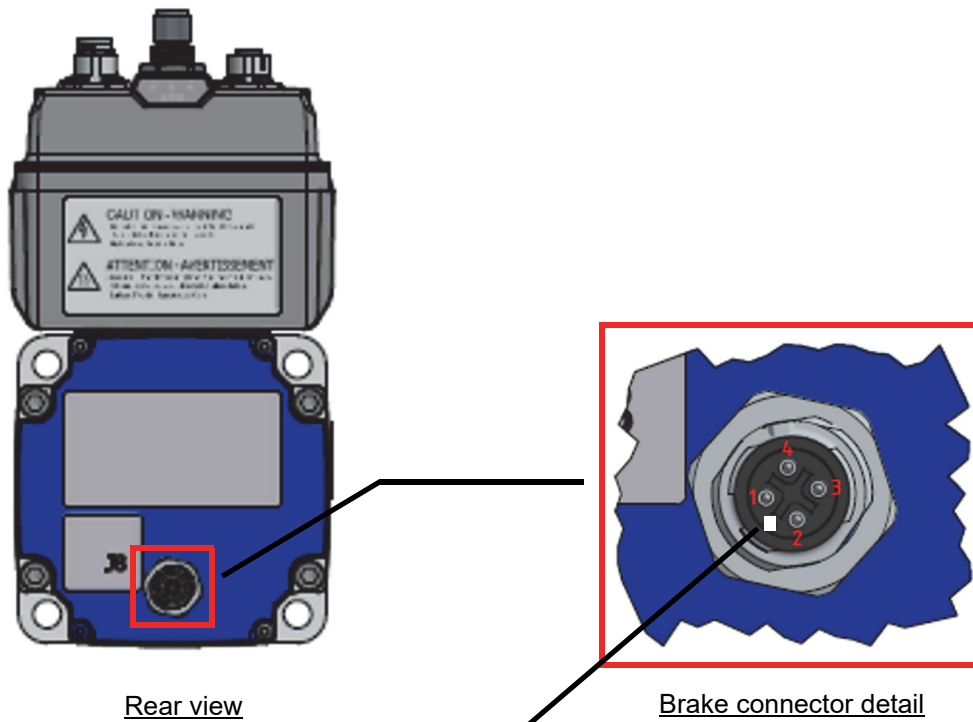

Rear view

Brake connector detail

Respect the orientation taking as a reference the white polarization indicated

Brake connector pinout table

Pin 1	NC
Pin 2	NC
Pin 3	GND
Pin 4	VCC

5 Installation and start-up

5.1 Preliminary operations

Before starting up the device, make the following checks:

- Check the perfect integrity of the device and its components.
- Make sure that all manuals necessary for installation are available.
- Read this manual integrally.

WARNING

	<p>Metal parts and all "live" parts can under certain conditions cause cuts and tears. Pay particular attention in case of contact and use suitable personal protective equipment (PPE).</p>
---	--

AVERTISSEMENT

	<p>Les pièces métalliques et toutes les pièces sous tension peuvent, dans certaines conditions, provoquer des coupures et des déchirures. Portez une attention particulière en cas de contact et utilisez un équipement de protection individuelle (EPI) approprié.</p>
---	---

WARNING

	<p>Use adequate tools during the assembly, in order to avoid crushing or abrasions.</p>
---	---

AVERTISSEMENT

	<p>Lors du montage de l'appareil, utilisez des outils appropriés pour éviter tout risque de blessure, d'écrasement, d'abrasion, etc.</p>
---	--

5.2 Installation mode

During the installation of the device, the upper and lower part and the side parts must have a free space of at least 100 mm compared to other electronic and / or mechanical components.

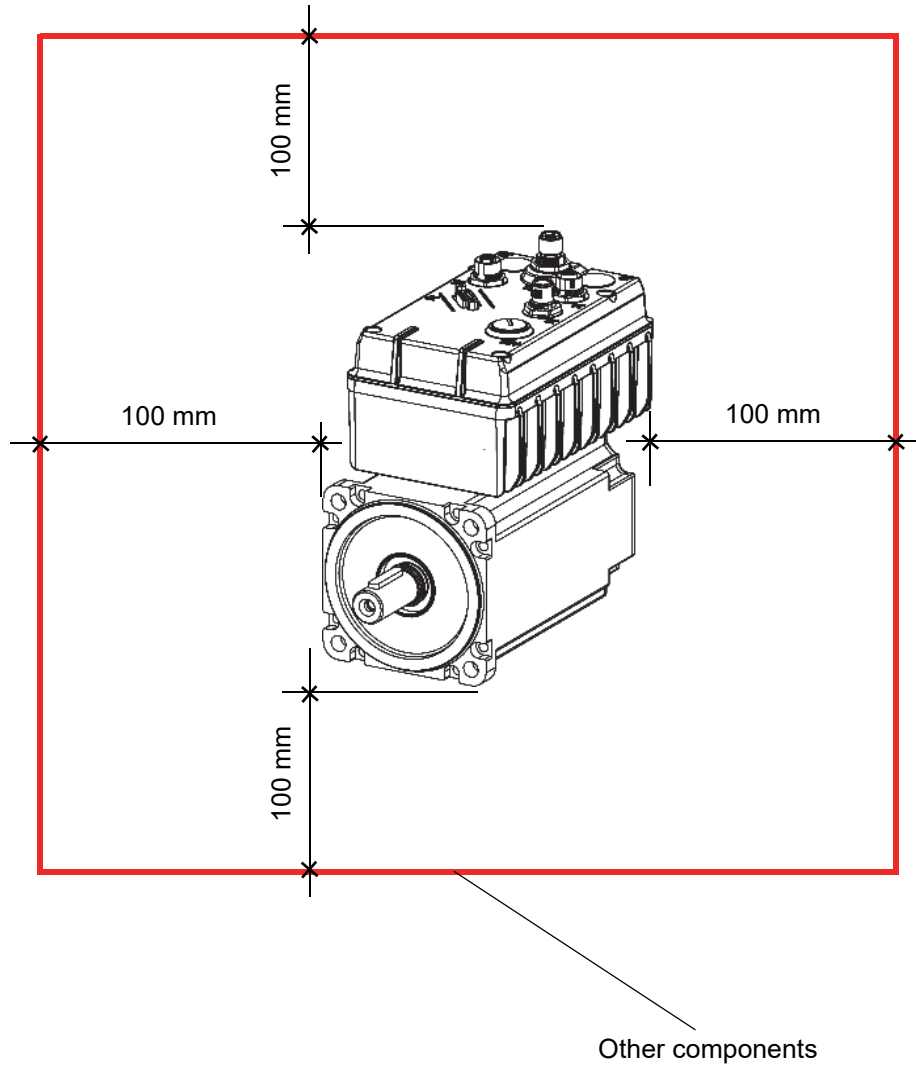

5.3 Mechanical assembly



5.3.1 Fastening

Tighten the flange with steel bolts, 8.8 grade or higher grade. The recommended tightening torques are indicated in the following table, which refers to new bolts with not lubricated threads.

THREAD SIZE	TIGHTENING TORQUE [Nm]
M6	10
M8	24
M10	48
M12	83

Reduce the tightening torque if the threads are lubricated (max. reduction 20% with MoS2 lubricant) Use flat washers for the bolts. In case of strong vibrations and/or shock loads, use Grover washers or apply threadlocker paste (Loctite 243 type or equivalent type).

Make sure the bearing surface is clean and flat (no dents or scratches, etc...), in order to avoid misalignment.

	During the servodrive assembly, always wear the personal protective equipment (PPE).
	

5.3.2 Torque transmission

The torque is transmissible with direct coupling or with belt or gears.

In case of direct coupling, try to reduce the axial and radial misalignment which would cause an additional pressure on bearings. This would considerably reduce their life and would cause vibrations. The misalignment can be measured by means of a centesimal comparator. The misalignment limit is equal to 0.03 mm both in radial and axial sense.

In case of belts, make sure that the motor shaft is perfectly parallel to the pulley axis. The pinion and the pulley must be aligned, in order to avoid undesired axial loads on the bearings and heavy wear of the drive belt. The belt tensioning must comply with the manufacturer's instructions and must not cause excessive radial load on the bearing, which would reduce its life.

In case of gears, observe their distance during the motor assembly. If you use helical gears, make sure the axial load does not damage the motor bearing. Check the radial load generated by the gears (especially with large pressure angles), in order to avoid a strong reduction of the bearing fatigue life. When assembling the pinion on the shaft, avoid radial stress to the motor bearing by using adequate tools.

For further information about the calculation of the bearings fatigue life depending on the load and on the rotation speed, please refer to Standard ISO 281.

5.4 Connections and LEDs

All connections of servodrives ICOS 3210 are ensured by removable connectors; the following picture shows the connectors position:

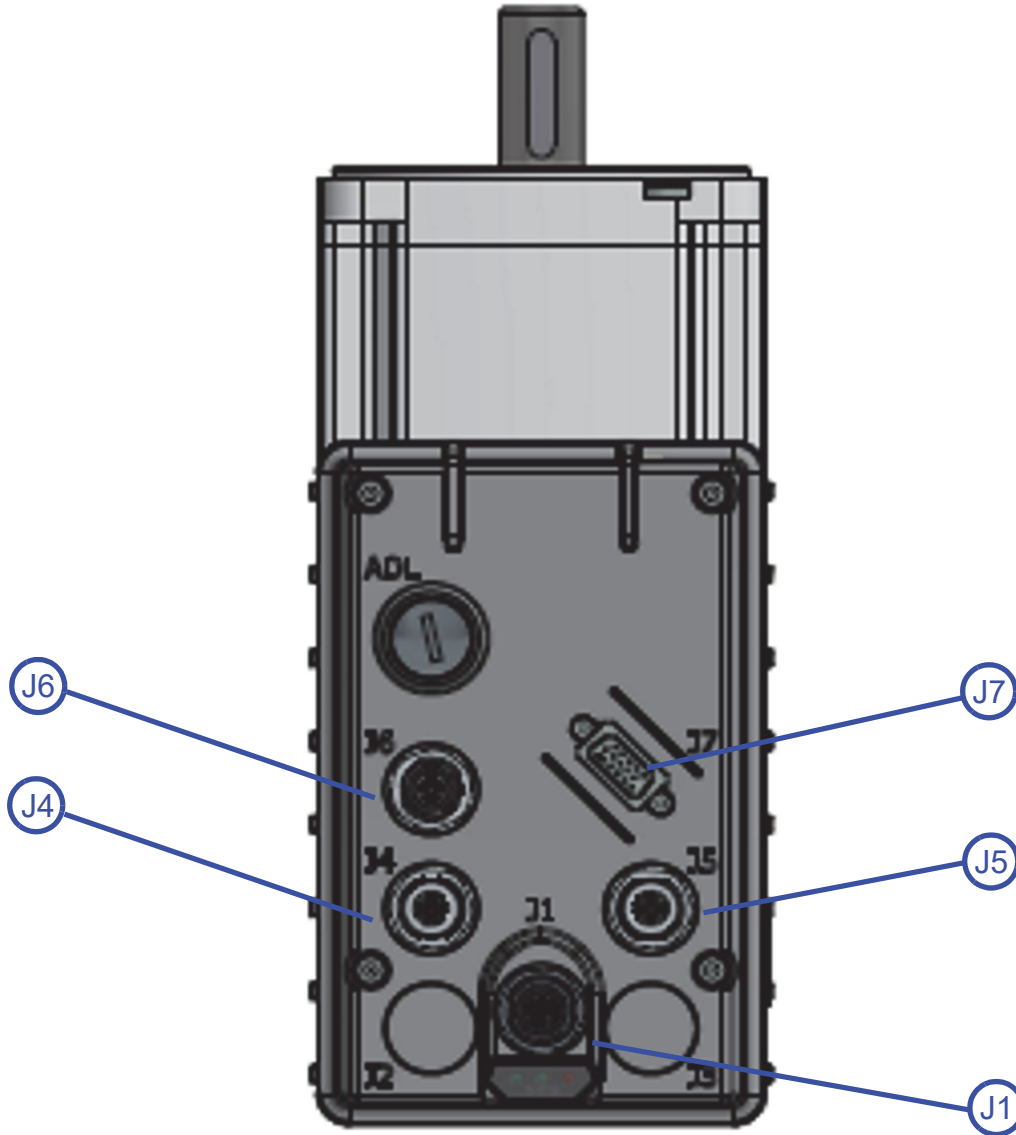

The following table describes the function of each connector:

Connections	
Code	Description
J1	DC power supply
J2	reserved
J3	reserved
J4	Field bus - output
J5	Field bus - input
J6	auxiliary power supply
J7	I/O

5.4.1 DC power supply - J1

These are the connections of the main power supply (DC bus), with corresponding connection of the protection earth (PE/Ground).

CAUTION



Large capacitors inside the device. Risk of Electric Shock; wait at least No. 600 seconds (10 minutes) after disconnecting power. Do not connect or disconnect cable and connectors before that time.

ATTENTION



Hautes capacités présentes à l'intérieur de l'appareil. Risque de choc électrique; attendez au moins 600 secondes (10 minutes) après la mise hors tension. Les câbles et les connecteurs ne doivent pas être connectés ou déconnectés avant la fin du temps indiqué.

The following picture shows the connector and the pin configuration:

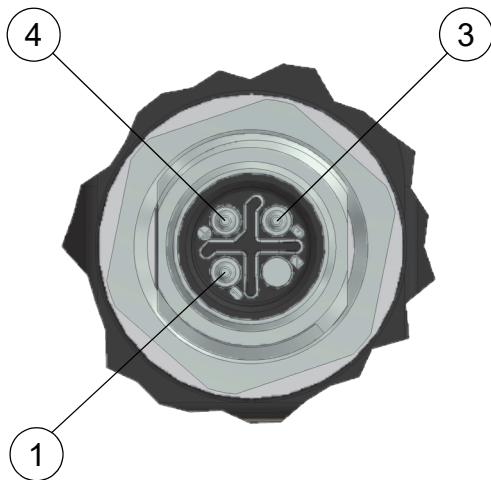

Main power supply	
Pin	Signal
1	B+ (positive)
2	NC
3	B- (negative)
4	PE (Ground)

Connector type: Phoenix Contact SACC-DSI-M12MSS-3P-M16/0,5 PE (1411653) * **	
Features	
Rated voltage	630 V
Rated current	16 A
N. poles	3
Mass resistance	≤ 3 mΩ
Insulation resistance	≥ 100 MΩ
Standards	M12 connector
Contact material	CuZn
Contact surface material	Au
Contact insert material	PA
Ring material	CuZn alloy, nickel
Seal material	FKM
Inflammability class according to UL 94	V0
*= Use 60 °C / 75 °C wires only	
**= Use Copper Conductors only	

The following picture shows the recommended connection scheme:

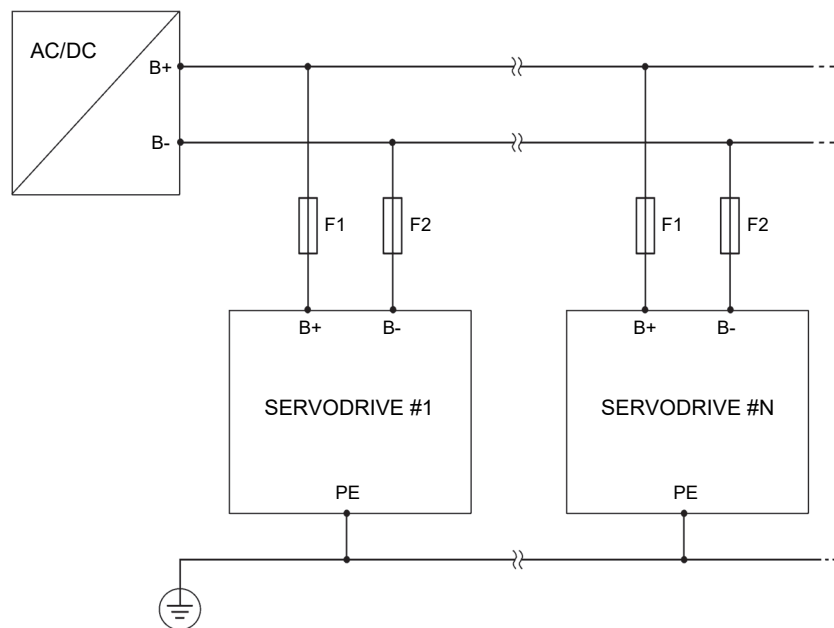

The mains voltage is obtained from the mains power supply through the power supply unit; be careful to the voltage polarity while making the connections.

CAUTION



For safety reasons, the device must always operate with PE (Ground) connection; risk of Electric Shock and/or malfunctions.

ATTENTION



Pour des raisons de sécurité, l'appareil doit toujours fonctionner avec la connexion PE (Ground) insérée; risque d'électrocution et / ou de dysfonctionnement de l'appareil.

CAUTION



The servomotor generates high earth leakage current; do not power the servomotor without PE (Ground) connection, to avoid the risk of Electric Shock if you touch metal components (such as the heat sink).

ATTENTION



Le servomoteur génère un courant de fuite élevé vers la terre; ne pas alimenter le servomoteur sans connecter PE (Ground) pour éviter le risque de choc électrique en touchant des parties métalliques exposées (par exemple, le dissipateur de chaleur).

5.4.1.1 Conductors and protective devices

5.4.1.1.1 Protection for UL applications



This device is Suitable For Use On A Circuit Capable Of Delivering Not More Than 5000 Arms Symmetrical Amperes, 325Vdc Maximum when protected by semiconductor fuse model FR10GR69V20 by Mersen.

5.4.1.1.2 Protection for other applications

The conductors cross section for wiring the connector must be equal to 1.5 mm²/ 16 AWG.

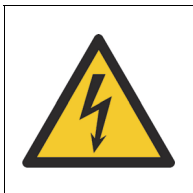

The use of conductors with lower section than the recommended value might cause fire or damage to people or property.

The device and the supply conductors must be protected against overload and short-circuits, by means of protective devices, able to interrupt continuous currents.

CAUTION



The use of an inadequate overcurrent protection device could cause a failure to intervene, with danger for people and things. Furthermore, spurious protection interventions may occur.

ATTENTION.



L'utilisation d'un dispositif de protection contre les surintensités inadéquat pourrait entraîner une absence d'intervention et entraîner des risques pour les personnes et les objets. De plus, des interventions de protection parasites peuvent se produire.

For an adequate protection of the device and of the conductors (according to IEC 60204-1), it is recommended to use fuses connected in series to both power supply lines. The protective conductor (PE/ Ground) must never be sectioned.

The following table indicates the recommended fuse features:

Class	gPV (IEC 60269-6)
Size	10x38 mm (13/32" x 1 1/2")
Rated current	12 A
Operating voltage	500V min.

The following table lists some adequate fuses:

Manufacturer	Part-number
Littelfuse	0SPF012.T
Littelfuse	KLKD012.T
Bussmann	PV-12A10F
Italweber	1463012
Mersen (Ferraz Shawmut)	HP6M12
Schrack	ISV10012

The breaking capacity of the fuse must not be lower than the maximum short-circuit current at the installation point; the short-circuit current must be limited to max. 5 kA at the servodrive input.

Should the servodrive be included in a machine, refer to the Standard EN 60204-1 for further details about its size.

The servodrive is not directly connected to the main power supply and does not integrate any filter to reduce emissions; the filtering must be ensured by the power supply unit and/or by an adequately sized filter. The acceptable levels of emission depend on the environmental and operating conditions (number of servodrives, cable length, current values, rules in force); the user is responsible for the choice of the filter.

5.4.2 Field bus - J4 and J5

	<p>Refer to the FlxIO bus integration and FlxMod system DK400076 manual for the correct definition of the connection topology of the FlxIO bus.</p>
---	---

The servomotors include an interface for the FlxIO field bus; it is based on an insulated electrical interface RS485 and ensures a reliable real-time check of complex applications.

The connections are made by means of connectors J4 and J5 situated on the front panel; the following picture shows the pin configuration of these connectors (the picture refers to connector 5; connector 4 is the same, but rotated by 180°).

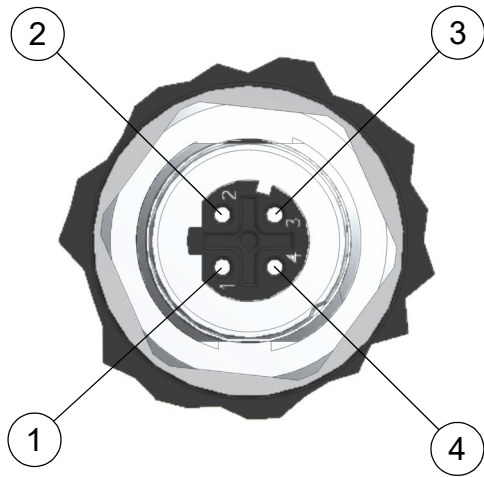

Field bus FlxIO			
J5 (input)		J4 (output)	
Pin	Signal	Pin	Signal
1	DATA+	1	DATA+
2	GND	2	GND
3	DATA-	3	DATA-
4	ADDR_IN	4	ADDR_OUT

Connector type: Phoenix Contact SACC-DSI-FSD-4CON-L180 SCO (1551503) * **	
Features	
Rated voltage	250 V
Rated current	4 A
N. poles	4
Standards	M12 connector IEC 61076-2-101
Degree of protection	IP67
Contact material	CuZn
Contact surface material	Au
Contact insert material	PA 66
Seal material	NBR

Screw material	CuZn alloy, nickel
Inflammability class according to UL 94	V0
*= Use 60 °C / 75 °C wires only **= Use Copper Conductors only	

The connections must be made with adequate cables for RS485 serial interfaces (shielded cables and at least a twisted pair with 120Ω impedance for differential signals); the following picture shows an example of cable wiring.

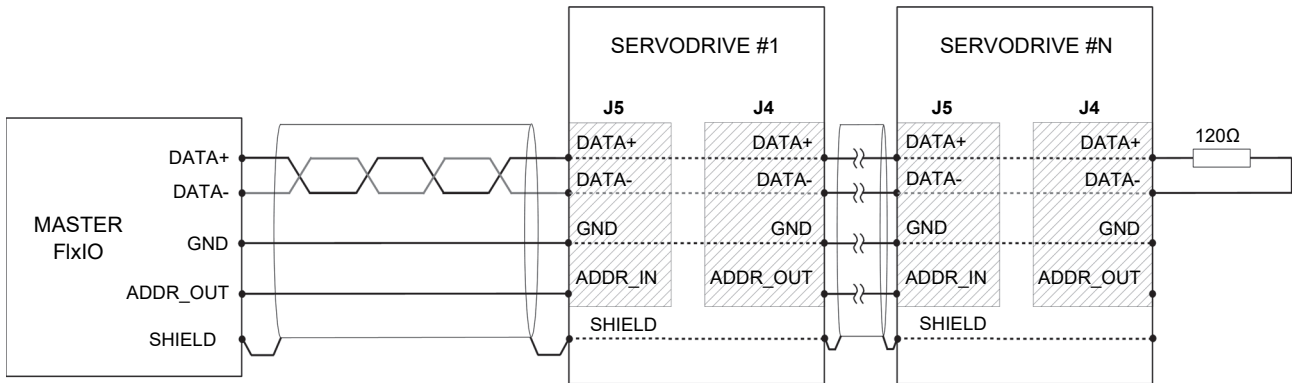

To prevent signal reflection, a 120Ω terminal resistor must be installed. The resistor is integrated in the connector KF131326, to be connected to connector J4. The termination is usually integrated in the master device. The mass connection (GND), though not essential for operation reasons, is recommended to improve the system immunity to EMC interferences.

The auxiliary addressing line (ADDR_IN and ADDR_OUT) is reserved to the automatic assignment of the address. This issue will be explained in details in paragraph 7.4 (Addressing).

5.4.3 Auxiliary power supply 24V - J6

This is the connector for the connection of auxiliary power supply 24V; the pin configuration is indicated here below:

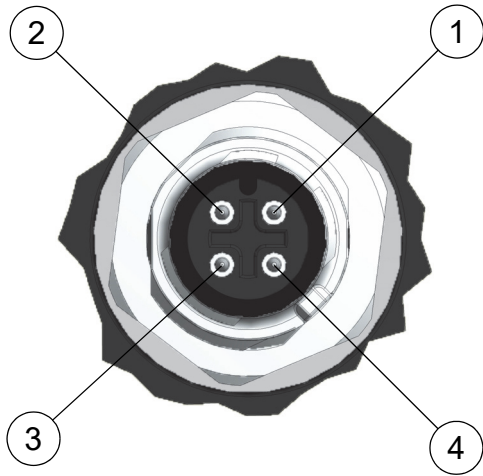

Auxiliary power supplies	
Pin	Signal
1	24V_I/O
2	NC
3	GND
4	24V_MAIN

Connector type: Phoenix Contact SACC-DSI-MS-4CON-L180 SCO - 1553459 * **	
Features	
Rated voltage	250 V
Rated current	4 A
N. poles	4
Mass resistance	≤ 3 mΩ
Insulation resistance	≥ 100 MΩ
Standards	M12 connector IEC 61076-2-101
Contact material	CuZn
Contact surface material	Au
Contact insert material	PA 66
Ring material	CuZn alloy, nickel
Seal material	FKM
*= Use 60 °C / 75 °C wires only	
**= Use Copper Conductors only	

Two different power supplies are provided: 24V_MAIN and 24V_I / O; they share the same ground (GND). The first one (24V_MAIN) is used to feed the control section of the device, while the second one (24V_I / O) feeds the 24V digital outputs and supplies power to any external sensors through pin 6 of J7 (ref. 5.4.4).

	<p>Check the voltage polarity before connecting the servodrive, in order to avoid damages to the device.</p>
	<p>The 24V cables must be protected against over-currents. Some types of power supply units function as a protection. For further details about the protections size, refer to the IEC 60204-1.</p>

Many installations feature two different types of 24V power supply: one for the power section and another one for the control section (usually supplied by UPS). The double supply avoids the machine switch off in case of blackout or power supply interruption due to external causes (for example in case of emergencies).

It is therefore advisable to connect only the 24V_MAIN power supply under backup, in this way the size of the UPS will be reduced.

This feature also allows the digital outputs to be disconnected (if required for safety reasons, for example) without turning off the servomotor.

	<p>If the auxiliary supply voltage is generated by two different power supply units, they must absolutely share the same ground. Otherwise the servodrives and/or the power supply units might be damaged.</p>
---	--

The auxiliary supply voltage must be stable and within the limits of the servodrives (refer to the paragraph on this subject). If this voltage is outside the prescribed limits, the servodrive might be damaged.

	<p>For safety reasons, these power supply must be supplied by a PELV power supply unit, with ground terminal connected to earth (preferably at one point only, in order to avoid ground loops).</p>
---	---

5.4.4 I/O - J7

This is the connector for I/O connection; here is the pin configuration of the connector:

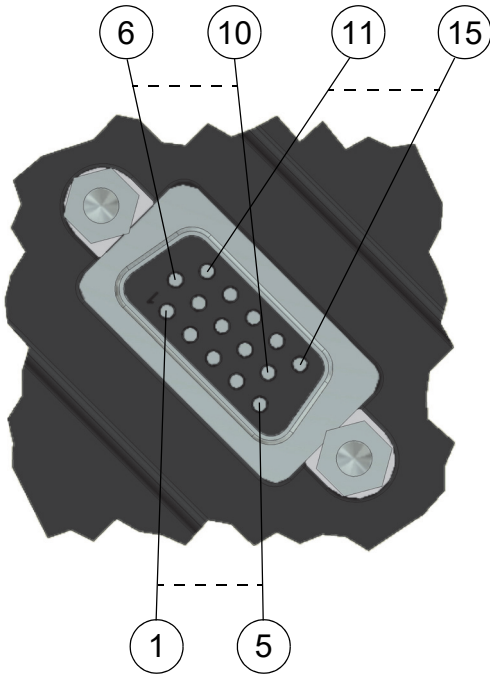

I/O	
Pin	Signal
1*	Digital I/O #4
2*	Digital I/O#3
3*	Digital I/O #2
4*	Digital I/O #1
5	GND digital I/O
6	Vs (24V)
7	Reserved
8	Reserved
9	Reserved
10	GND digital I/O
11	Digital input #2
12	Digital input #1
13	GND input 4÷20 mA
14	Input 4÷20 mA
15	Reserved

Note: pin 6 of the connector (Vs 24V) is to be used exclusively to power any sensors or actuators external to the drive; the maximum current that can be taken is 700mA. The maximum total current that can be taken from Vs and from the digital outputs is 1A.

* Note: for code EM700047 only, pins 1, 2, 3 and 4 are digital outputs and not I/O

Connector type: Amphenol F 15P / 3F 0° 2,29MM DSUB WP (HDB-15PFFP-SL8001) * **	
Features	
Rated current	5 A
N. poles	15
Resistance of contact	≤20 mΩ
Isolation resistance	≥500 MΩ to DC500V
Contact material	Copper alloy, gold-plated
Connector body material	Nylon 9T or PBT
Body material	Steel, nickel-plated
Seal material	Silicone
Screw material	Copper alloy, nickel-plated

*= Use 60 °C / 75 °C wires only
 **= Use Copper Conductors only

The following paragraphs describe the I/O, their wiring and how to use them.

5.4.4.1 24V digital inputs

The servomotors feature six general-purpose 24V digital inputs; four of them have a double function of input and output (I/O). Only the EM700047 servomotor, differs from the other models, due to the presence of 4 non-I/O digital outputs.

These inputs are typically used to acquire data from sensors with a digital output, which are very common in the industrial field (example: photocells, limit switches, etc...).

The following picture shows an example of how a sensor is connected; in most applications, an ordinary unshielded cable can be used for the wiring.

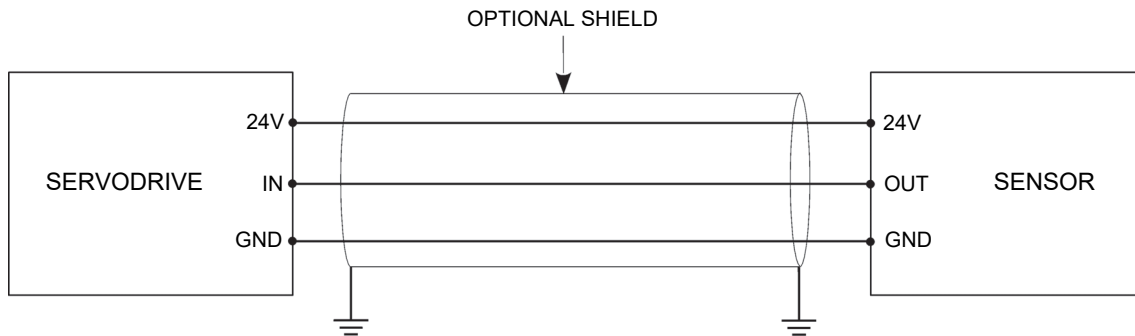

However, if the operating environment is affected by significant electrical noise or the distances to be covered are significant, it might be necessary to use a shielded cable. In this case, the shield must be connected to the connector shell of the servodrive, with low RF impedance; the shield is totally ineffective if it is left floating. In most cases, it can be useful to connect the shield to earth on the other end of the cable; this is to be avoided if it causes ground loops due to different potentials between the shielded cable ends. Therefore, a correct connection must be determined according to the application.

Signal quality may be further improved by keeping the cables as far away as possible from noise sources such as power cables, inverters, power supply units, relays, etc...



Check the sensor polarity before connection; inverted polarity can damage the sensor and/or the servodrive.

5.4.4.2 24V digital outputs

The servomotors, as already said for the digital inputs, feature four general-purpose 24V digital I/O (current-sourcing pnp). Only the EM700047 servomotor, differs from the other models, due to the presence of 4 non I/O digital outputs.

They are typically used for piloting 24V actuators (such as solenoid valves, relay or contactor coils, lamps, etc...) or for generating digital signals (for example, for communicating with a PLC).

The following picture shows an example of actuator connection; in most applications, the wiring does not require a shielded cable, unless it is a source of interference for other devices in the nearby.

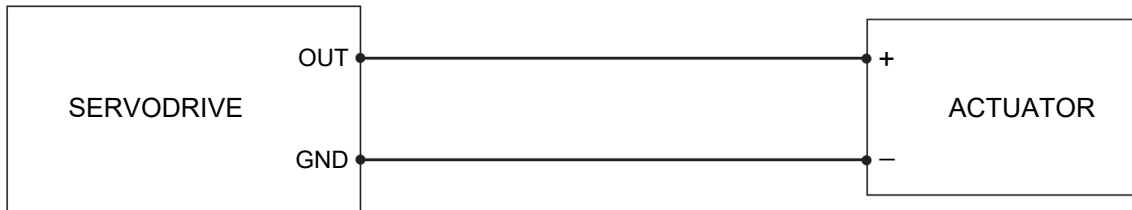

If a digital signal must be generated for communicating with another device (such as a PLC), the recommended connection scheme is as follows:

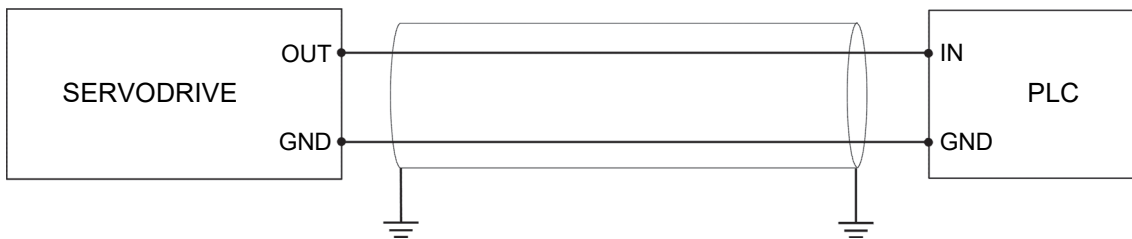

In this case, there is greater likelihood of electrical interferences, therefore it is recommended to use shielded cables to make connections; the shield must be connected to the connector shell of the servodrive with a low RF impedance connection; the shield is totally ineffective if it is left floating. In most cases, it can be useful to connect the shield to earth on the other end of the cable; this is to be avoided if it causes ground loops due to different potentials between the shielded cable ends. Therefore, a correct connection must be determined according to the application.

It is important to consider that the inputs and outputs are electrically connected to each other (I/O). Should an output be activated, the corresponding input will read this status. For example, if an output is powered by 24Vdc, the corresponding input will read this voltage (with the exception of the EM700047 servomotor).

5.4.4.3 Analogue input 4÷20mA

The servodrives are equipped with one analogue input for 4÷20 mA signals. The use of sensors with current outputs is very common in the industrial field, thanks to better immunity to electrical interferences, as compared to voltage signals. A further advantage is represented by the easy detection of a disconnected cable (current absence).

The most common type of sensor only features two contacts: one for 24V power supply and one as an output; this is the recommended connection scheme:

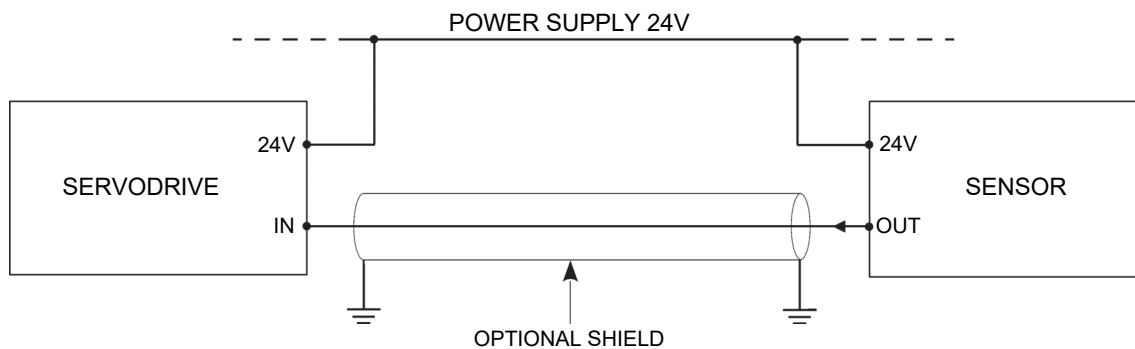

If possible, the sensor must be directly powered by the servodrive connector, as indicated in the following picture:

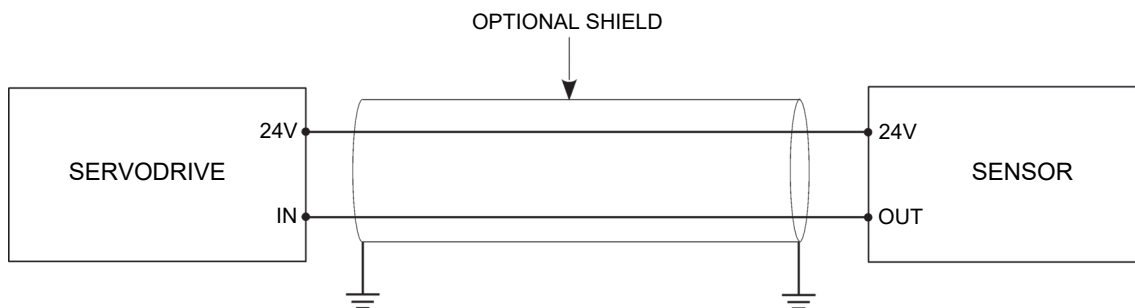

Since the 4÷20 mA signals have a good immunity to electrical interferences, a non-shielded cable can be used for the wiring in most cases. However, in case of long-distance branches or harsh environments, the use of shielded cables is preferable. If possible, keep the cables as far away as possible from noise sources (power cables, inverters, switched-mode power supplies, contactors, motors, etc...).

5.4.5 LEDs

The device has 3 LED indicators, marked with the STS label, which inform the user about the state of the field bus (FlxIO), of the supply lines and of the operating condition.

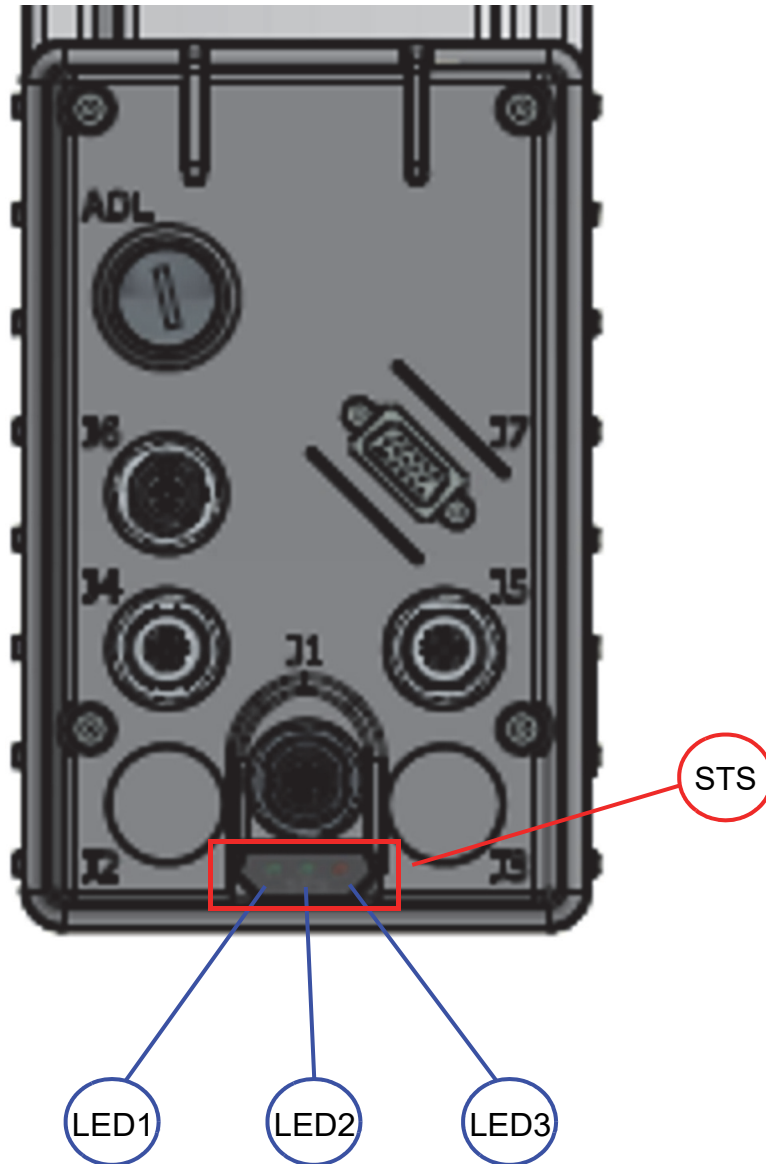

5.4.5.1 References signaling LEDs (STS)

Name	Function
LED1	State of the 24V I/O power supply line (green LED)
LED2	Fieldbus status (green LED)
LED3	Fieldbus status (red LED)

5.4.5.2 LED1 behavior

LED1 (green)	Meaning
ON	24V I/O supply voltage present
OFF	24V I/O supply voltage absent

5.4.5.3 LED2 and LED3 behavior

They take on the following meaning, in accordance with the FlixIO standard, based on their switching on and off and the frequency with which they flash:

LED2 (green)	LED3 (red)	Meaning
Flash 1Hz	ON	Controller firmware update dedicated to FlixIO communication
ON or OFF	ON	Controller hardware fault dedicated to FlixIO communication
Flash 1Hz	OFF	Initialization of FlixIO communication in progress
Flash 4Hz	OFF	FlixIO communication in error
ON	OFF	Indicates whether the communication of the master FlixIO device is active or not (bootloader phase)

In the event of an error, the diagnostics is returned via the FlixIO bus; so if you need to know the type of error that occurred, you will need to query the system via the FlixIO bus.

5.4.6 Installation criteria for UL certification

	<p>Cord connected device are for use only in NFPA 79 applications.</p>
	<p>Integral solid state short circuit protection does not provide branch circuit protection. Branch circuit protection must be provided in accordance with the Manufacturer Instructions, National Electrical Code and any additional local codes.</p>
	<p>The drive does not provide Motor Overload protection. External or remote Motor Overload protection shall be provided in the end-use applications.</p>
	<p>Motor over-temperature sensing function is provided connecting the UL certified sensor positioned in to the motor, to the control board of the drive. For ICOS Series this connection is internal to the enclosure and was made by the manufacturer.</p>

5.5 Addressing

Like all slave devices with FxIO field bus, the ICOS servodrives need to be addressed for a correct data exchange with the master device. Each slave device must have its own address; two devices with the same address cause communication problems and might cause uncontrolled behaviour of the system. It is possible to address up to 15 devices in the same bus.

The addressing of servodrives can be either manual or automatic; you can find further details in the following paragraphs.

For further details about the FxIO field bus operation and connection topologies, refer to the specific documentation.

5.5.1 Manual addressing



The servodrive address must be set by means of the rotary switch situated on the front panel, accessible by unscrewing a cap (labelled with the word ADL; see picture).

The switch can be set to 16 different positions, from 0 to F (hexadecimal notation), by using a flat screwdriver.

After setting the address, screw the cap, in order to grant the protection degree (IP) of the device.

The following table shows the correspondence between decimal values and hexadecimal values:

Decimal	0	1	2	3	4	5	6	7	8	9	10	11	12	13	14	15
Hexadecimal	0	1	2	3	4	5	6	7	8	9	A	B	C	D	E	F

Address 0 must never be used.

Since the address is acquired by the servodrive only after supplying auxiliary voltage, the setting must be carried out before powering it, otherwise the variation is ignored until the servodrive is started again.

	Make sure the address is correct before powering the devices, otherwise the system behaviour may be uncontrolled; danger to people and/or properties.
	Once you removed the cap, be very careful that nothing falls inside the device, in order to avoid damages or electrical shocks.

5.5.2 Automatic addressing

Up to date, this mode can not be used; however, you can find here a short description.

In this mode, the address of the servodrive is set automatically, according to the order of connection of the devices in the bus. Thanks to the bus cascading, the master device FxIO assigns the addresses in sequence; the first device connected to the master will take address 1, the second device connected in cascade to the first one will take address 2 and so on.

6 Firmware upgrade

Following significant improvements or additional functionalities, the servodrives of the ICOS 3210 series can be updated with a more recent firmware version.

This operation can be carried out through FlxIO field bus (remote programming); if the master device recognizes that the servodrive is programmed with a different FW version as compared to the version loaded in the memory, it automatically re-programmes it. The procedure can be carried out when the devices are started. It is not possible to upgrade a device directly.

To upgrade the servodrives, it is necessary to upgrade the FW of the master device, which will then upgrade the slaves.

7 Storage

The device and its components can be stored in their original packaging and always in a covered place, even if they are packed. Protect the device against dust and atmospheric agents.

Do not stack more than 10 power supply units, in order to avoid overstretching the package and/or device.

The storage temperature should be within -25° and $+55^{\circ}\text{C}$.

8 Maintenance

SMITEC S.p.A. does not recommend any ordinary maintenance of the servodrives ICOS 3210; it is not allowed to disassemble any component, because it might compromise the safety degree of the device.

Any repairs must be performed exclusively by SMITEC S.p.A.

9 Disposal and demolition

The disposal of this device must be carried out according to the laws in force in the country where it was installed. Should the disposal be partial (frame, heat sink, electronic boards), separate the components made of plastic from the components made of aluminium, etc. Their disposal must be in compliance with the law in force in the country where the device was installed.

10 Analytical index

A

Accessories.....	19
Altitude	16
Analogue input.....	42
Assembly	7
Automatic addressing	47
Auxiliary power supply	37

D

DC power supply.....	30
Degree of protection	14
Delivered torque.....	11
Digital inputs	40
Digital outputs	18

E

Electrocution	8
Electromagnetic field.....	9

F

Fastening	27
Field bus	35
FLxIO	35, 46

H

Handling.....	7
Holding brake.....	21

I

I/O	39
Individual protections	6

J

J1	29, 30
J4	29, 35
J5	29, 35
J6	29
J7	29, 39

M

Manual addressing.....	46
Mechanical power	13

O

Operating temperature.....	14
----------------------------	----

P

Positioning	25
Power supply	16
Preliminary operations	25

R

Rotation speed	12
Rotor moment of inertia.....	14

S

Shaft diameter	14
Storage temperature	16

T

Torque transmission.....	28
--------------------------	----

W

Weight	20
--------------	----