

Smitec S.p.A., via Carlo Ceresa 10, 24015 San Giovanni Bianco (BG), Italy, www.smitec.it



Installation, use and maintenance manual



BEFORE USING THE MODULES OF THE HELCON 10XX SERIES, YOU MUST READ THIS INSTALLATION AND USE MANUAL CAREFULLY AND FOLLOW ALL THE INDICATIONS TO GUARANTEE THE MAXIMUM SAFETY

CONTROL MODULE IR LAMPS HELCON 10XX SERIES



The technical data and the drawings in this manual might have been modified later; always refer to the latest version.

Summary

1 Preface	3
2 General warnings	4
3 Safety instructions	6
3.1 General information	6
3.2 Precautions during handling and assembly	6
3.3 Precautions against the risk of electrocution	7
3.4 Precautions against contact with hot parts	7
3.5 Residual risks	7
4 Technical data	8
4.1 Environmental characteristics	8
4.2 Electrical characteristics	9
4.2.1 Lamp pilot outputs	9
4.3 Mechanical specifications	10
4.3.1 Weight	10
4.3.2 Dimensions	10
4.4 Order codes	11
4.5 Accessories	11
5 Installation and commissioning	12
5.1 Preliminary operations	12
5.2 Mechanical assembly	13
5.2.1 Positioning and fixing	13
5.3 Connections	16
5.3.1 Power supply - J1	17
5.3.1.1 Connection scheme	18
5.3.1.2 Electromagnetic compatibility	20
5.3.2 Fieldbus - Connector J2 and J3	20
5.3.3 24VDC input power supply - J4 connector	22
5.3.4 24VDC power supply - J5 connector	23
5.4 LEDs	24
5.4.1 Fieldbus status	24
5.4.2 Auxiliary power supply status	25
5.5 Addressing	25
5.5.1 Manual addressing	26
5.5.2 Automatic addressing	27
5.6 Power output	28
5.6.1 HELCON 1008	28
5.6.2 HELCON 1010	29
5.6.3 HELCON 1010 RETROFIT	30
6 Operation and diagnostics	31
7 Storage	32
8 Firmware upgrade	33
9 Maintenance	34
9.1 Fuse replacement	34
9.2 Replacement of the SSR module	35
9.3 Assembly of additional ventilation kit	37
9.4 Periodic maintenance - Clamping of fuse terminals	39
9.4.1 Model without current distributor	39
9.4.2 Model with current distributor	40
10 Disposal and demolition	41
11 Analytical index	42

1 Preface

This manual provides all necessary information for the installation, use and maintenance of the control module IR lamps HELCON 10XX series.

The instructions included in this manual are addressed to the following professionals:

User	User is a person, a company or an institution that buys the equipment and uses it for the purposes it was designed for.
User/operator	User or operator is a person authorized by the user to operate on the equipment.
Specialized personnel	It refers to all persons with specific competence, able to recognize and avoid the dangers deriving from the use of the equipment.

The present instructions must be made available to all the above individuals.





2 General warnings



These assembly instructions are an integral part of the equipment, and must be kept for future reference until it decommissioned.

The user should be informed that the present instructions reflect the state of the art at the moment when the equipment was sold; they will remain fully acceptable despite subsequent upgrades based on new technical update.

	<p>DO NOT USE THE EQUIPMENT, NOR MAKE ANY INTERVENTION BEFORE INTEGRALLY READING AND UNDERSTANDING THIS MANUAL.</p>
<p>IN PARTICULAR, ADOPT ALL SAFETY PRECAUTIONS AND PRESCRIPTIONS INDICATED IN THIS MANUAL.</p>	
<p>THE EQUIPMENT MUST BE USED FOR PURPOSES DIFFERENT THAN THE ONES DESCRIBED IN THIS MANUAL; SMITEC S.p.A. SHALL NOT BE HELD RESPONSIBLE FOR ANY DAMAGES, INCONVENIENCES OR ACCIDENTS DUE TO THE NON-COMPLIANCE WITH THESE PRESCRIPTIONS.</p>	

In order to make the manual consultation easier, the following symbols have been adopted:

	<p>Indication of "PROHIBITED ACTION".</p>
	<p>The symbol "DANGER" is used when non-compliance with the prescriptions or misuse may cause serious injuries.</p>
	<p>The symbol "DANGER FROM HOT SURFACES" is used when non-compliance with the prescriptions or misuse may cause serious injuries.</p>
	<p>The symbol "DANGER FROM ELECTRICAL SHOCK" is used when non-compliance with the prescriptions or misuse may cause serious injuries.</p>



	The symbol "USE OF INDIVIDUAL PROTECTIONS" means that protective gloves must be worn.
	The symbol "USE OF INDIVIDUAL PROTECTIONS" means that protective glasses must be worn.
	Indication of "INFORMATION OF PARTICULAR RELEVANCE".

The safety prescriptions aim at establishing a series of behaviors and obligations to be complied with, while performing the activities described later on in this manual.



These prescriptions constitute the prescribed method of operating the device, in a way that is safe for personnel, equipments and environment.

3 Safety instructions

3.1 General information

	<p>Do not install or use the equipment before integrally reading and understanding this manual. In case of difficulties of interpretation, contact SMITEC technical service.</p> <p>It is absolutely forbidden to use the equipment for different purposes than the ones described in this manual. The technical data and the drawings in this manual might have been modified later; always refer to the latest version. All upgrades can be requested to SMITEC S.p.A. directly.</p>
	<p>Make sure that the personnel is qualified and adequately informed about the risks he may run and how to avoid them.</p>
	<p>The use of the HELCON 10XX series IR lamp control modules is authorized only after classification of the operating area of the final machinery and verification of safety levels, which must be congruent with the safety levels of the unit.</p>

3.2 Precautions during handling and assembly

	<p>Metal components and sharp surfaces may cause cuts and tears. In case of contact, be very careful and wear the personal protection equipment.</p>
	<p>Use adequate tools during the assembly, in order to avoid crushing or abrasions.</p>

3.3 Precautions against the risk of electrocution

	<p>The main power connector is subjected to high voltages during module operation; pay attention (danger of electrocution).</p>
	<p>During all phases of installation and maintenance of the equipment, disconnect it safely from the power supply network. Electrolocation risk.</p>
	<p>Some components of the apparatus (for example: the aluminum heatsink) are made of conductive materials. They must be connected securely to the protective conductor (PE) using the appropriate terminals, to avoid risk of electrolocation.</p>
	<p>Never use the device partially or totally disassembled. Danger of electric shock and / or damage to persons and property.</p>

3.4 Precautions against contact with hot parts

	<p>The parts of the apparatus can reach an extremely high temperature in operating mode or post-operation; take particular care not to touch the parts of the equipment in these cases, or use special protections and precautions during handling: HOT SURFACE, RISK OF BURNS.</p>
	<p>By using the device in the construction of a machine, the manufacturer must take all precautions to avoid the operator's contact with the hot parts, to avoid the risk of burns.</p>

3.5 Residual risks

	<p>The apparatus generates an electromagnetic field during operation. Danger for people with pacemakers, metal prostheses or hearing aids.</p>
---	--

4 Technical data

	<p>All the technical information reported in this section are consistent with the hardware configuration of the HELCON module produced at the date of writing of this document. With the aim of technologically improving or updating the product, SMITEC S.p.A. reserves the right to change the technical characteristics of the HELCON module without prior notice.</p>
---	--

4.1 Environmental characteristics

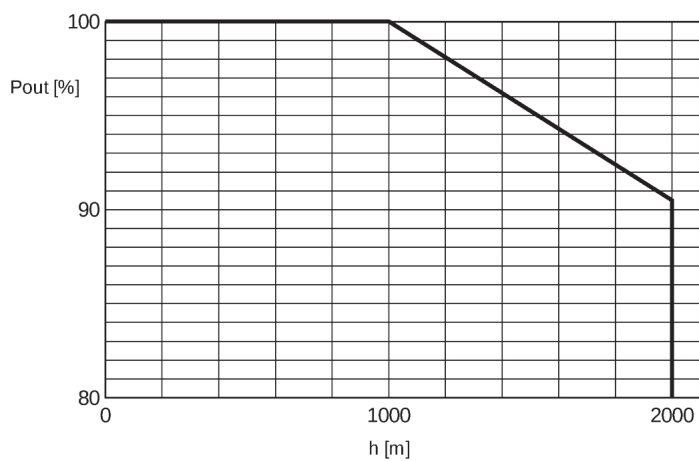
Operating temperature Model: HELCON 1010 Code: KZ010458 e KZ010488	0° ÷ +45°C (without external ventilation kit)										
	0° ÷ +55°C (with external ventilation kit)										
Operating temperature Model: HELCON 1008 Code: KZ010478	0° ÷ +50°C (without external ventilation kit)										
	0° ÷ +55°C (with external ventilation kit)										
Storage temperature	-20°C ÷ +70°C										
Maximum altitude	1000 m a.s.l. at nominal output current										
	2000 m a.s.l. with current derating										
Output current derating as a function of altitude	 <table border="1"> <caption>Data points for Output current derating as a function of altitude</caption> <thead> <tr> <th>Altitude (h [m])</th> <th>Output Current (Pout [%])</th> </tr> </thead> <tbody> <tr> <td>0</td> <td>100</td> </tr> <tr> <td>1000</td> <td>100</td> </tr> <tr> <td>2000</td> <td>90</td> </tr> <tr> <td>2000</td> <td>80</td> </tr> </tbody> </table>	Altitude (h [m])	Output Current (Pout [%])	0	100	1000	100	2000	90	2000	80
Altitude (h [m])	Output Current (Pout [%])										
0	100										
1000	100										
2000	90										
2000	80										
Degree of protection of the enclosure	IP65										

4.2 Electrical characteristics

Main power supply voltage	400VAC -10% ÷ 480VAC +5%
Type of power supply	2PH 50/60 HZ
Maximum short-circuit current	5 kA at the point of installation
Current main power consumption Model: HELCON 1010 Code: KZ010458 and KZ010488	63.8A
Current main power consumption Model: HELCON 1008 Code: KZ010478	60.0A
Power input main power Model: HELCON 1010 Code: KZ010458 and KZ010488	25.5kW
Power input main power Model: HELCON 1008 Code: KZ010478	24.0kW
Auxiliary power supply voltage	24V DC -15 ÷ +20%
Current consumption of auxiliary power supply	0.5A



The input current strongly depends on the impedance of the network; the values shown refer to a perfectly sinusoidal network with zero generator impedance. In real cases there is a reduction in the input current value which can exceed 30%.

4.2.1 Lamp pilot outputs

Type of electric load	Halogen infrared lamps
Utilization category	AC-55b (according to EN 60947-4-3)
Current max. deliverable on a single output	7.5A RMS

4.3 Mechanical specifications

4.3.1 Weight

The following table shows the weight of the various models:

Type	Weight (kg)
KZ010458	15.0 kg
KZ010478	14.1 kg
KZ010488	15.0 kg

4.3.2 Dimensions

External measurements of the only device:

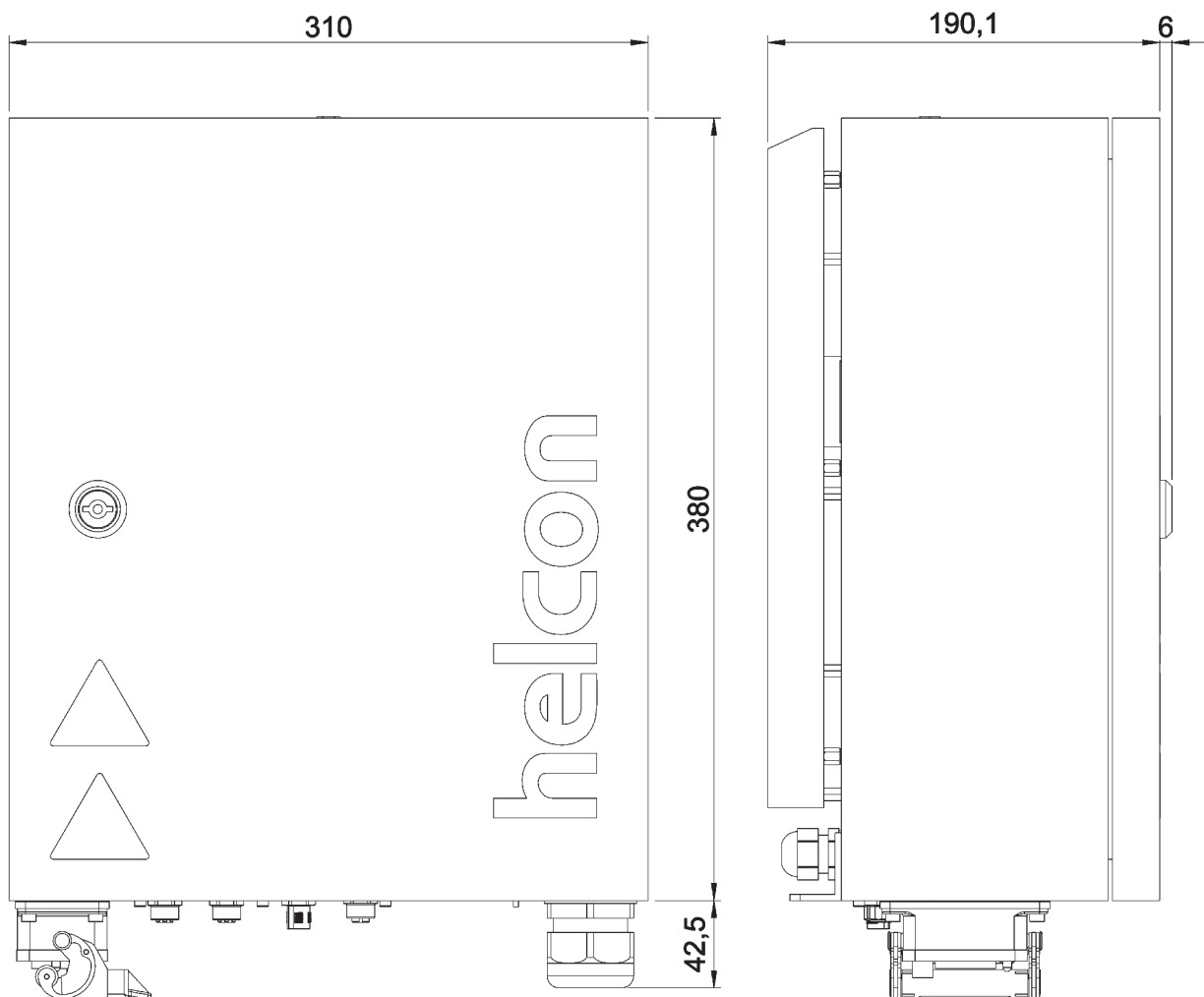

4.4 Order codes

Order code	Model	Description
KZ010478	HELCON 1008	IR 400V single-phase lamps control module with 8ch x 3kW, max 24kW total.
KZ010458	HELCON 1010	IR 400V single-phase lamps control module with 10ch x 3kW, max 25.5kW total.
KZ010488	HELCON 1010 RETROFIT	IR 400V single-phase lamps control module with 10ch x 3kW, max 25.5kW total, with special wiring for retrofitting machines with Olicorp modules.

4.5 Accessories

Below is the list of order codes:





Order code	Article
EE500170	Spare fuse (class gG, 12A 500V RAPID, 10,3x38 mm)
EE500232	Spare fuse (class gG, 1A 500V, 10,3x38 mm)
KS011367	Electronic board static relay module for replacement (SSR)
KM030002	Non-silicone thermal conducting paste for mounting SSR modules. It is supplied in a 35ml syringe.
KG020094	External ventilation kit
KF131326	Connector with termination resistor for FLxIO bus, type M12 male

5 Installation and commissioning

5.1 Preliminary operations

Before putting the device into service, check the following:

- verify the perfect integrity of the unit and its components
- check that all the documentation necessary for the installation is present
- read and understand the following manual in its entirety

	<p>During the installation of the HELCON module, it is necessary to avoid falls and violent impacts which could compromise its regular operation.</p>
	<p>Avoid directly touching the input/output connectors located on the underside of the HELCON module unless you are equipped with suitable protective equipment for static electricity; any discharges on the connectors could in fact damage the device.</p>
	<p>Always make all electrical connections with the equipment off: this will avoid damage to the computer and danger to the operator.</p>
	<p>Use suitable tools when assembling the equipment, to avoid the risk of injury, crushing, abrasion, etc...</p>
	<p>The metal parts and all the "live" parts can under certain conditions cause cuts and tears. Pay particular attention in case of contact and use suitable personal protective equipment (PPE).</p>
	<p>Do not position the device in such a way that it is difficult to disconnect the wiring connected to it.</p>

5.2 Mechanical assembly

5.2.1 Positioning and fixing

The HELCON series modules are suitable for “exposed” mounting; to ensure effective heat dissipation, it is necessary to mount them in a vertical position, using the fixing holes provided for this purpose.

The following image shows the dislocation of the upper fixing holes, which is realized by means of a metal insert with metric thread M6 (MA pitch). The stem portion of the screw entering the insert must not exceed 14 mm (recommended value 12 mm). Use screws with a strength class of 8.8 or higher; the recommended tightening torque is $10 \text{ Nm} \pm 10\%$. In the presence of vibrations, we recommend the use of anti-unscrew washers (for example Grover or Belleville), or use medium braid compound (Loctite 243 or equivalent).

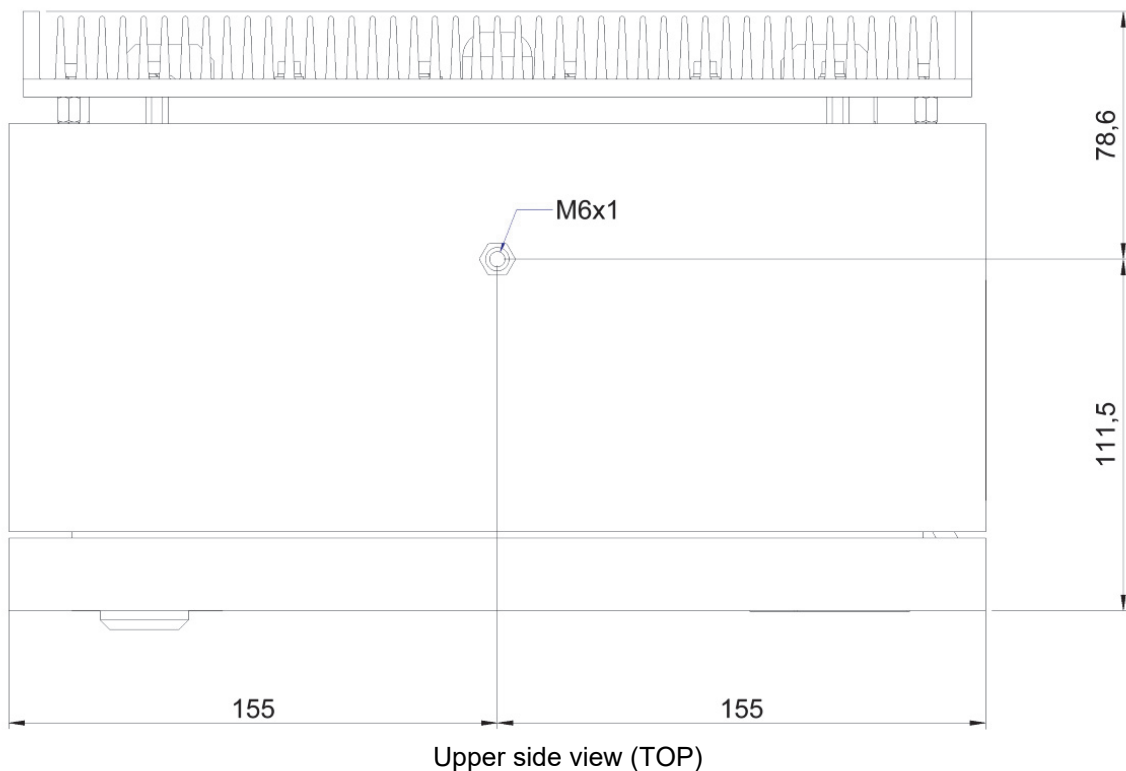

The following image shows the dislocation of the lower fixing holes, made within two metal support ears. The fixation of the device to the support can be carried out by means of through screws fitted with a locknut. As regards the choice of suitable screws, please refer to the above.

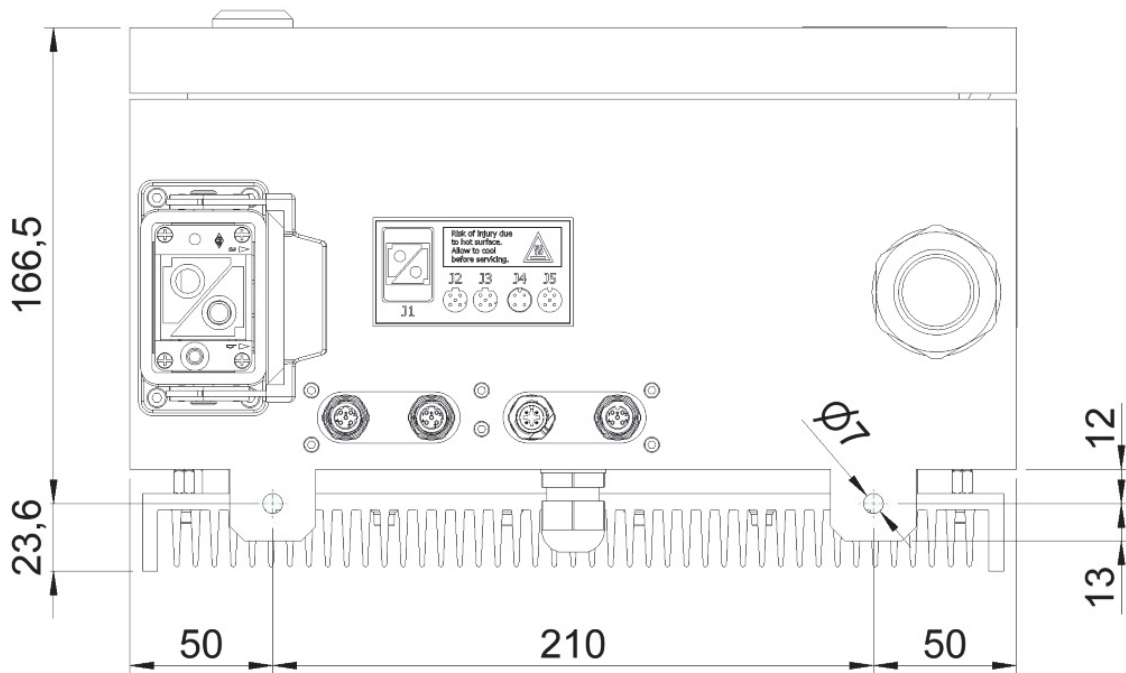

Bottom side view (BOTTOM)

In some installations, the support may be subject to considerable vibration, which could damage the device. In this case, it is recommended to use dampers (“silentblock”) made of elastomeric material, whose characteristics must be determined on the basis of the magnitude and frequency of the vibrations themselves. For how to assemble the same, refer to the manufacturer's instructions.

The HELCON 10XX series modules entrust the heat dissipation to an aluminum heatsink mounted on the back of the same. To ensure optimal performance of the same, it is necessary to keep minimum distances during assembly, both from the mounting wall and from nearby objects.

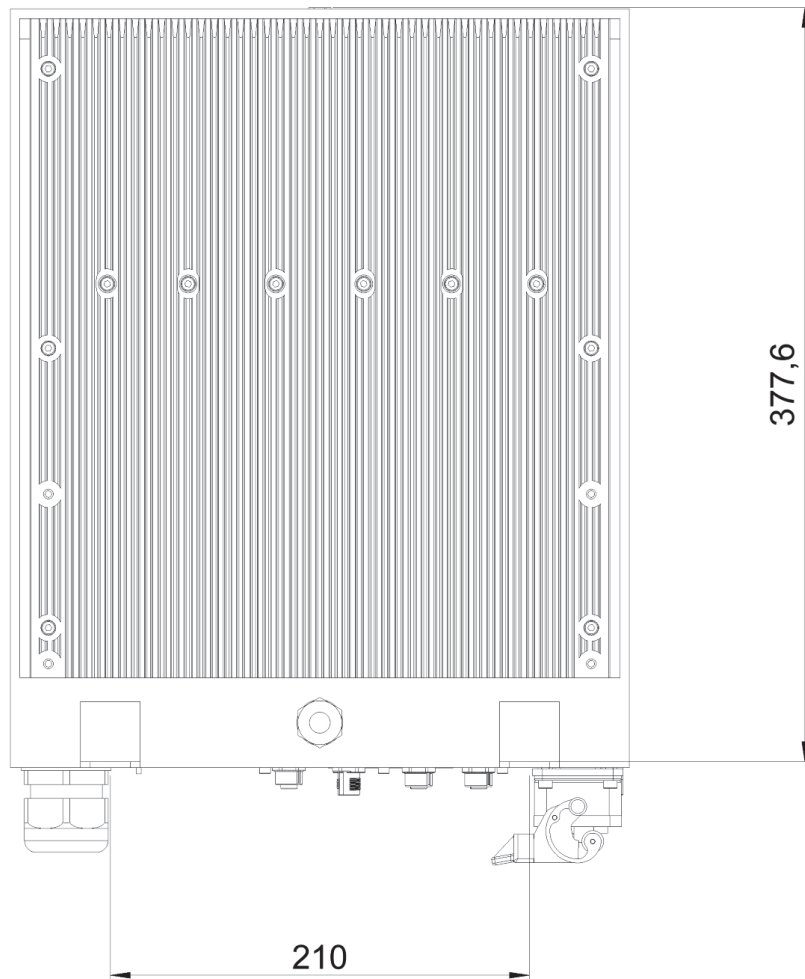

Rear side view (REAR)



Check at regular intervals, the cleaning of the heatsink fins. The dirt accumulated between them prevents the disposal of heat, causing overheating of the module and a possible reduction of its operating life.

If the module is to operate in particularly hot environments, the disposal of heat by natural convection becomes insufficient. In this case, a special external ventilation kit must be used.



External ventilation kit

5.3 Connections

The connectors are located at the bottom.

The following image shows the connections available on the bottom of the equipment:

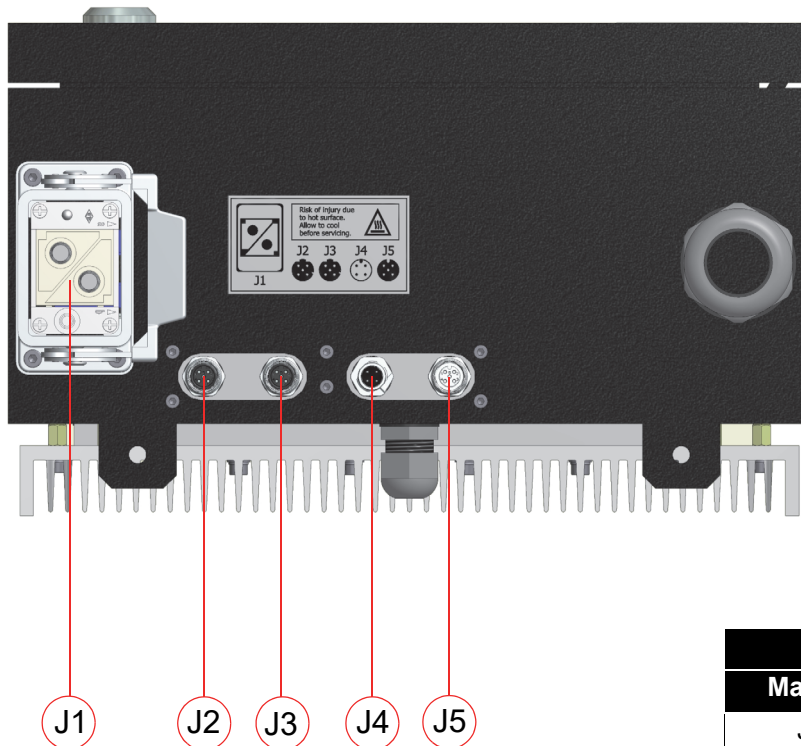

Connections	
Marker	Description
J1	Main power supply
J2	Field bus - input -
J3	Field bus - output -
J4	24V DC - input -
J5	24V DC - output -

5.3.1 Power supply - J1

This is the mains supply (2 PH), using the J1 connector (2-pole 1000V 100A male; manufacturer: Ilme, code CX 02 GM). The image and the pinout of the connector are shown below:

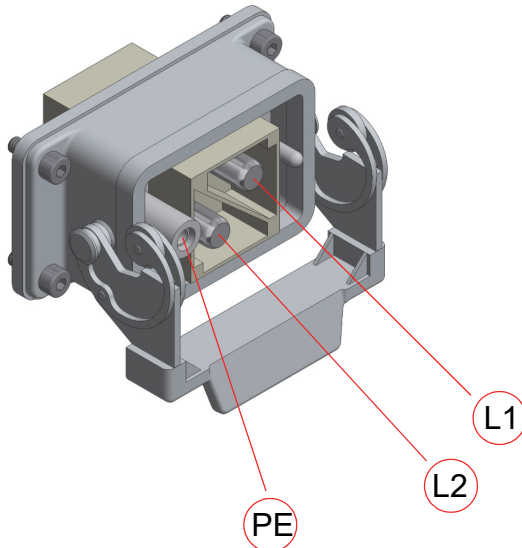

400 VAC power supply	
Marker	Signal
L1	400 VAC network - phase 1
L2	400 VAC network - phase 2
PE	Earth protection

The following paragraphs describe in detail how the connections are to be made.



For safety reasons, the device must always operate with the PE connection inserted; danger of electrocution! The cross-section of the protective conductor (PE) must be not less than that of the phase conductors.

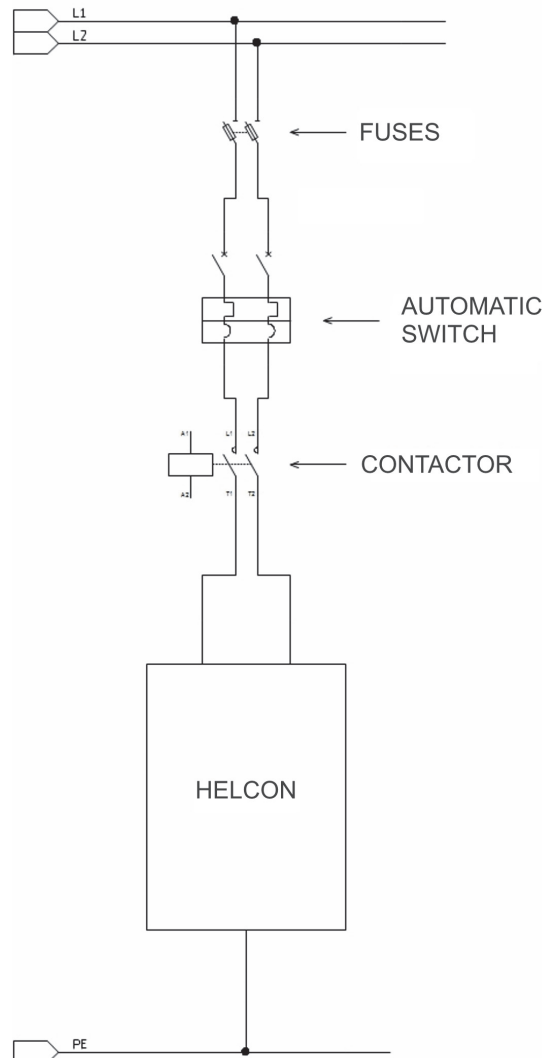

5.3.1.1 Connection scheme

The HELCON 10XX series modules are designed to operate on networks with TT or TN distribution. The operation is not foreseen on IT networks, or with so-called “corner grounded” distributions. The following image illustrates a typical usage scheme:



The protection of the device and of the power supply cables must be carried out by means of circuit breakers of the magnetothermic type with tripping curve C complying with the EN IEC 60947-1 standard. The size of the same must be 63A for modules with 8 outputs and 80A for those with 10 outputs. The short-circuit current provided at the point of installation must not exceed 5 kA.

In the case in which the maximum short-circuit current exceeds this limit, in order to protect the apparatus and avoid damage to people and property, upstream of the automatic circuit-breaker use devices that are suitable to limit the short-circuit current to a value not higher at 5 kA. Such devices could be constituted by fuses, or switches-limiters. Contact SMITEC for information on the sizing of the same.

	<p>Do not install the device where the expected short-circuit current exceeds 5 kA. Danger of fire and damage to people and property.</p>
	<p>The use of an inadequate overcurrent protection device could cause it to fail to intervene, with danger for people and things. Additionally, spurious protection interventions may occur.</p>

The sizing of the power cable depends on various factors:

- Module size (8 or 10 outputs)
- Environment temperature
- Type of cable used
- How to lay the cable

It is necessary to guarantee the protection against short circuit and overload of the cable, respecting the prescriptions contained in the IEC 60204-1 standard. In case the apparatus must equip machinery that must meet different standards, refer to them for more details.

The following table summarizes the minimum sections required for the power supply cable, using cables with PVC insulation of 70 ° C, or XLPE / EPR from 90 ° C, assuming that the above protection devices are used upstream of them. This table presupposes a laying of the cable in free air (similar to the installation category E of IEC 60364-5-52).

Environment temperature [°C]	Modules with 8 outputs (KZ010478)		Modules with 10 outputs (KZ010458 and KZ010488)	
	PVC	XLPE/EPR	PVC	XLPE/EPR
40	16 mm ² / 6 - 5 AWG	10 mm ² / 8 - 7 AWG	16 mm ² / 6 - 5 AWG	16 mm ² / 6 - 5 AWG
45			25 mm ² / 4 - 3 AWG	
50			35 mm ² / 2 AWG	
55	25 mm ² / 4 - 3 AWG			

If you intend to use cables of different types, or the way of laying cables is different from the one illustrated above, please refer to the IEC 60364-5-52 standard for more information on the criteria for dimensioning them.



The use of conductors with a section less than the recommended value could cause fire risk and damage to people and things.

In many installations multiple modules are used at the same time, in this case it is recommended to distribute the same on the various network phases trying to equalize as much as possible the load on the various phases.

5.3.1.2 Electromagnetic compatibility

The HELCON 10XX series modules are designed to operate on industrial type electrical networks, defined as “environment A” by the EN IEC 60947-1 norm (Class A appliance, CISPR 11).

As such, provided they are installed in accordance with this manual by skilled personnel and respecting the rules of good technique, they do not require the installation of additional measures (eg network filters, filtering capacitors, reactors, etc.) to obtain a installation in compliance with current directives.



The device must always work with the PE connection inserted. In the absence of it, it may not meet the requirements of electromagnetic compatibility, as well as being a potential danger to people and things.

In order to avoid interference and / or malfunctions of the module and other equipment, it is advisable to ensure that the power cables are placed at a safe distance from other cables belonging to different circuits, particularly if they transmit analog signals and / or high frequency.

5.3.2 Fieldbus - Connector J2 and J3



Refer to the FlxIO bus integration and FlxMod system DK400076 manual for the correct definition of the connection topology of the FlxIO bus.

The HELCON 10XX modules are equipped with an interface for the FLxIO proprietary fieldbus; it is based on an isolated RS485 electrical interface, and allows a reliable real-time control of complex applications.

Connections are made via connectors J2 and J3 (female, 4-pole, M12, shielded, D-coded, for IP65 Ethernet connections; manufacturer: Phoenix Contact, code 1436550) on the lower panel.

The following illustration shows the pinout of the same (the image shows the connector J2, the connector J3 is the same).

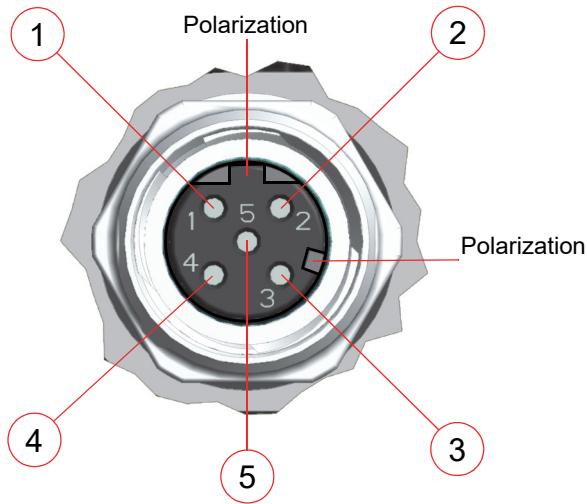

FLxIO field bus			
J2 (input)		J3 (output)	
Pin	Signal	Pin	Signal
1	DATA+	1	DATA+
2	GND	2	GND
3	DATA-	3	DATA-
4	ADDR_IN	4	ADDR_OUT
5	NC	5	NC

The connections must be made with suitable cables for RS485 serial lines (shielded and with at least one twisted pair with 120Ω impedance for the differential signals); the following image shows an example of wiring.

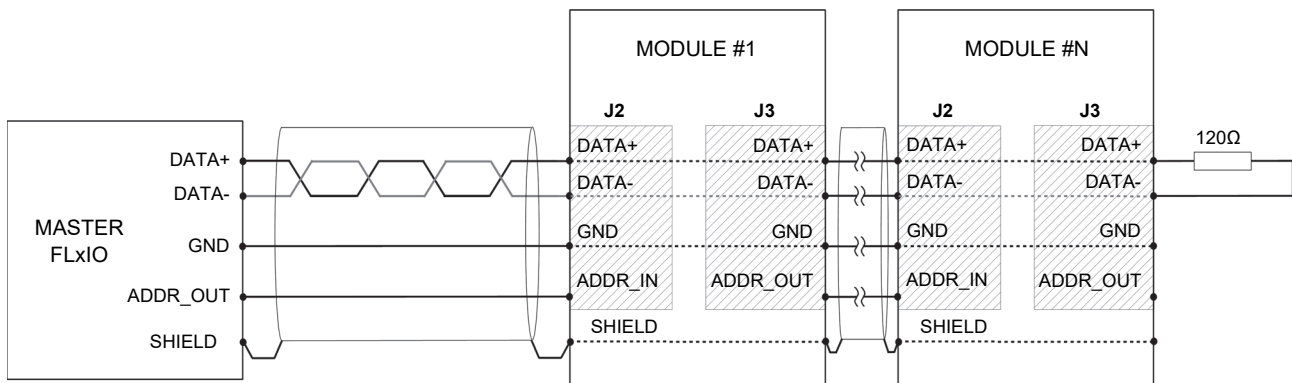

To avoid reflections, which are detrimental to signal quality, especially in the case of long distances, it is necessary to connect a 120Ω termination resistor to the end of the line. To facilitate this termination, the resistor is integrated into the KF131326 connector, to be connected to the J4 connector. The termination at the beginning of the line is usually integrated into the master device. The ground connection (GND), although not essential for functional reasons, is however recommended to improve the immunity of the system against EMC disturbances.

The auxiliary address line (ADDR_IN and ADDR_OUT) is reserved for automatic address assignment.

5.3.3 24VDC input power supply - J4 connector

The J4 connector (4 poles, 90° male type M12, polarization A; manufacturer: Phoenix Contact, code 1436589) makes available the input of the external 24V DC power supply.

The pinout of the connector is shown in the following image:

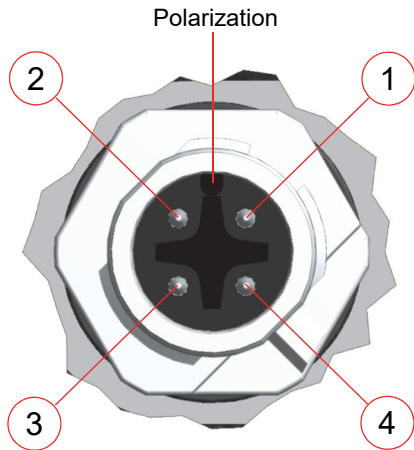

24VDC	
Marking	Signal
1	24V
2	24V
3	GND
4	GND

	<p>Check the polarity of the voltages before connecting the module; risk of damage to the unit.</p>
	<p>The 24V power supply cables must be equipped with overcurrent protection devices. Some types of power supply perform their own protection function.</p>

The voltages to the auxiliary power supplies must be stable and contained within the limits of the HELCON 10XX series modules (refer to the specific paragraph). If these voltages are outside the prescribed limits, the unit may be damaged.

	<p>For safety reasons, these power supplies must be supplied by a PELV power supply, with the ground terminal connected to the ground (preferentially only at one point to avoid ground loops).</p>
---	---

5.3.4 24VDC power supply - J5 connector

The J5 connector (4 poles, 90 ° female type M12, A-coded; manufacturer: Phoenix Contact, code 1436564) makes the output of the external 24V DC power supply available.

The pinout of the connector is shown in the following image:

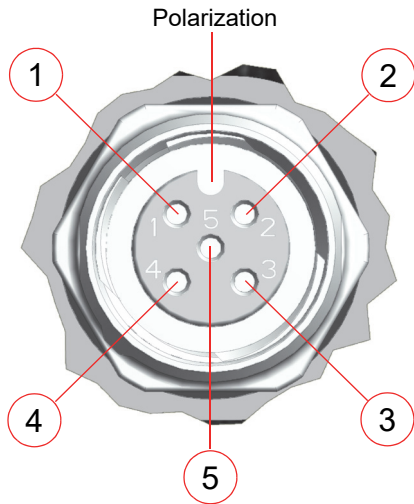

24VDC	
Marking	Signal
1	24V
2	24V
3	GND
4	GND
5	NC

The 24VDC output supplied by the J5 connector is used to eventually connect other modules installed in the ring. A maximum of 8 HELCON modules can be connected in cascade.

5.4 LEDs

The device has LED indicators that inform the user about the status of the fieldbus (FLxIO), of the power supply line and of the operating condition.

5.4.1 Fieldbus status

LEDs have the following meaning, in compliance with the FLxIO standard; they are marked in this manual with the abbreviations FLT and STS:

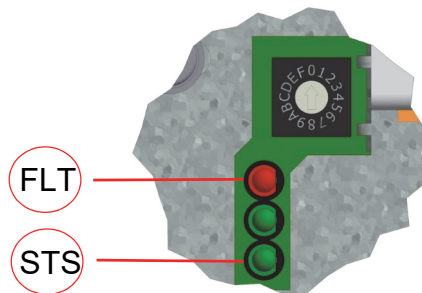

FLT	STS	DESCRIPTION
RED	GREEN	
ON	FLASH 1Hz	Firmware update FLxIO communication controller
ON	ON o OFF	Fault hardware FLxIO communication controller
OFF	FLASH 1Hz	Initialization of FLxIO communication in progress
OFF	FLASH 8Hz	Communication in error
OFF	ON	FLxIO master not active: bootloader phase FLxIO master active: active communication The status is distinguishable by observing the status LED on the coupler

5.4.2 Auxiliary power supply status

The status of the 24VDC power supply line is signaled by the green LED, marked in this manual with the initials PWR.

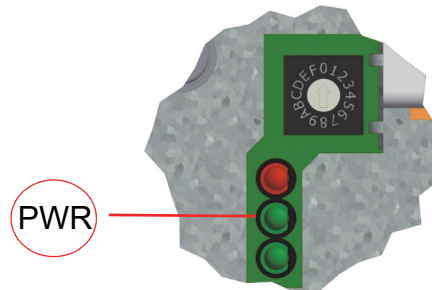

PWR	DESCRIPTION
GREEN	
ON	Presence of 24VDC power supply voltage
OFF	Absence of 24VDC power supply voltage

5.5 Addressing

As with all other FLxIO fieldbus slave devices, the HELCON 10XX series modules also need to be addressed to correctly exchange data with the master device. Each slave device inserted in the same bus must have its own and exclusive address; the presence of two devices with the same address causes communication problems and could lead to uncontrolled system behavior. It is possible to address up to 15 devices in the same bus. The addressing of the HELCON 10XX series modules can be done in two different ways: manual or automatic addressing; in the following paragraphs, they are explained in greater detail.

For more information on the general operation of the FLxIO bus and the possible connection topologies, refer to the relative documentation.

5.5.1 Manual addressing

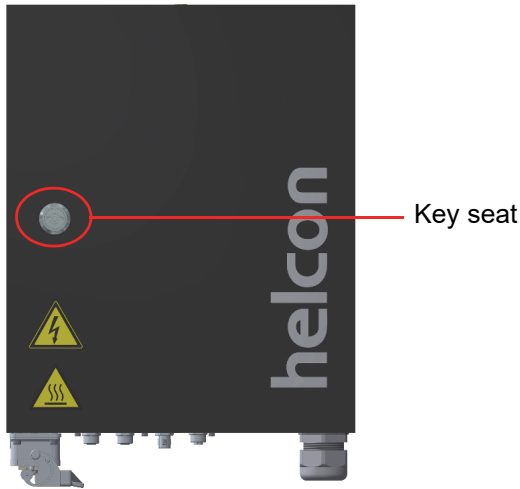

In this mode the module address must be set using the special rotary switch located inside the module, accessible by opening the device's door using the appropriate dedicated key.



Insert the key in the seat indicated in the figure and turn it anticlockwise. The door opens with a folding opening.

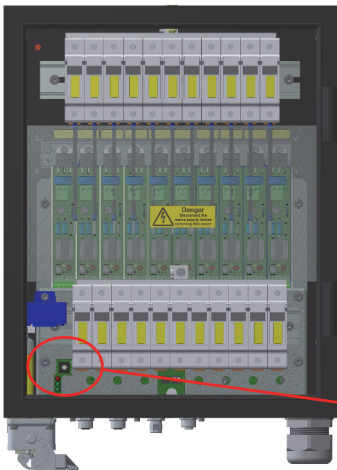

The switch can be set to 16 different positions, from 0 to F (hexadecimal notation), using a small flat-blade screwdriver. After setting the address, close the door with the appropriate key so that the device maintains the IP65 protection rating.

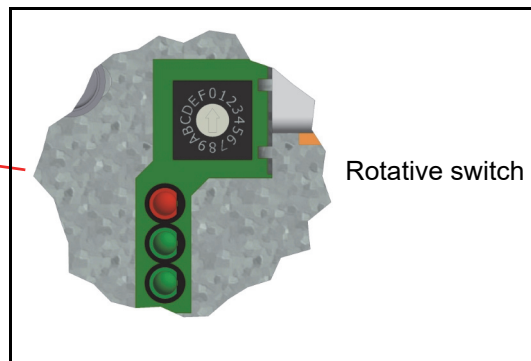

The following table shows the correspondence between decimal and hexadecimal values:

Decimal	0	1	2	3	4	5	6	7	8	9	10	11	12	13	14	15
Hexadecimal	0	1	2	3	4	5	6	7	8	9	A	B	C	D	E	F

Address 0 must never be used.

Since the address is acquired by the module only when the auxiliary voltage is switched on, the setting must be made before powering it, otherwise the variation is ignored until the next power up of the module.



Check the correctness of the address before powering the devices, or the system may have unpredictable behavior; danger of damage to people and/or things.

5.5.2 Automatic addressing

At the date this manual is written this mode can not be used, but a brief description of its operation follows.

In this mode the module address is set automatically according to the order of connection of the device in the bus. In fact, taking advantage of the cascade connection of the bus, the FLxIO master device assigns the addresses sequentially; the first device connected to the master will thus take address 1, the second device connected in cascade to the first will take address 2 and so on.

5.6 Power output

This is the connector for connecting the lamps. The type of connector differs in the various versions of the module.

5.6.1 HELCON 1008

Connector female fruit 16 pole 500V 16A with spring connection made of self-extinguishing thermoplastic resin (code N120770, manufacturer: Weidmuller).

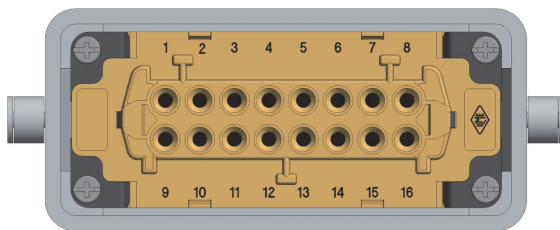

Connector view

Function	Pinout
Lamp 1	PIN 1
	PIN 9
Lamp 2	PIN 2
	PIN 10
Lamp 3	PIN 3
	PIN 11
Lamp 4	PIN 4
	PIN 12
Lamp 5	PIN 5
	PIN 13
Lamp 6	PIN 6
	PIN 14
Lamp 7	PIN 7
	PIN 15
Lamp 8	PIN 8
	PIN 16
Earth protection	PE

5.6.2 HELCON 1010

Connector female 24 pole 500V 16A female with spring connection made of self-extinguishing thermoplastic resin (code CSHF 24, manufacturer: Ilme).

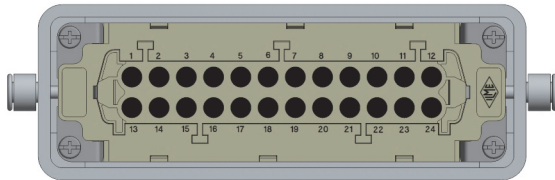

Connector view

Function	Pinout
Lamp 1	PIN 1
	PIN 13
Lamp 2	PIN 2
	PIN 14
Lamp 3	PIN 3
	PIN 15
Lamp 4	PIN 4
	PIN 16
Lamp 5	PIN 5
	PIN 17
Lamp 6	PIN 6
	PIN 18
Lamp 7	PIN 7
	PIN 19
Lamp 8	PIN 8
	PIN 20
Lamp 9	PIN 9
	PIN 21
Lamp 10	PIN 10
	PIN 22
Earth protection	PE

5.6.3 HELCON 1010 RETROFIT

Connector female fruit 32 poles 500V 16A with spring connection made of self-extinguishing thermoplastic resin (code CQEF 32, manufacturer: Ilme).

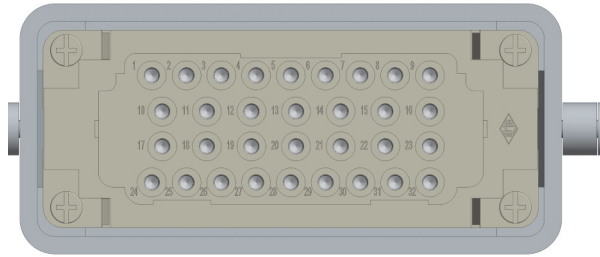

Connector view

Function	Pinout
Lamp 1	PIN 1
	PIN 24
Lamp 2	PIN 2
	PIN 25
Lamp 3	PIN 3
	PIN 26
Lamp 4	PIN 4
	PIN 27
Lamp 5	PIN 5
	PIN 28
Lamp 6	PIN 6
	PIN 29
Lamp 7	PIN 7
	PIN 30
Lamp 8	PIN 8
	PIN 31
Lamp 9	PIN 9
	PIN 32
Lamp 10	PIN 10
	PIN 17
Earth protection	PE

6 Operation and diagnostics

The HELCON 10XX series modules are designed for the control of infrared halogen lamps. Each module allows the piloting of 8 (HELCON 1008) or 10 lamps (HELCON 1010), with control of the power level supplied to each lamp.

The electronics are housed inside a sturdy metal case with IP65 protection rating, suitable for “visible” mounting directly on the machine. It is equipped with a watertight inspection door that can be opened only by means of a special key (supplied). The wiring is ensured by robust removable connectors with mechanical retention, making it easier to replace a defective unit.

An aluminum heatsink mounted on the back of the device allows the thermal dissipation of the module, without the use of additional “fanless” fans. The absence of weary elements increases the reliability of the device.

The device works with two-phase alternating power supply, and the power outputs are made by electronic switches (TRIAC). In order to reduce the harmonic distortion of the absorbed current as much as possible, the module performs the switching of the outputs in correspondence with the zero of the voltage (zero-crossing). Each power output is mounted on a separate module, easily replaceable in case of damage.

The protection fuses of the outputs are housed inside each module, making the installation extremely compact. The interfacing with the process controller is guaranteed by a proprietary FLxIO real-time fieldbus based on RS485. The bus is wired using M12 connectors, allowing standard pre-printed cables to be used.

The internal management electronics also allows the following features:

- Compensation of the mains voltage (the output power output is made independent of the supply voltage).
- Diagnostic check of the lamps.
- Reading of the resistance of the lamps.
- Checking the internal temperature of the device and its diagnostics.

7 Storage

The device and its components can be stored in their original packaging and always in a covered place, even if they are packed. Protect the device against dust and atmospheric agents.

Do not stack more than 3 modules, in order to avoid overstretching the package and/or device.

The storage temperature should be within -20° and $+70^{\circ}\text{C}$.

8 Firmware upgrade

Following significant improvements or additional functionalities, the IR lamp control module can be updated with a more recent firmware version.

This operation can be carried out through FLxIO field bus (remote programming); if the master device recognizes that the module is programmed with a different FW version as compared to the version loaded in the memory, it automatically re-programmes it. The procedure can be carried out when the devices are started. It is not possible to upgrade a device directly.

To upgrade the IR lamp control module, it is necessary to upgrade the FW of the master device, which will then upgrade the slaves.

9 Maintenance



Before carrying out any type of maintenance operation, disconnect power to the device and disconnect all electrical connections.

9.1 Fuse replacement

- Safely disconnect the equipment from the power supply.
- Open the door with the appropriate key provided.
- Open the failed fuse holder door.
- Remove the faulty fuse.
- Insert the replacement fuse. Use only fuses with the same rated current and the same type as the original one.
- Close the fuse holder door making sure it has come to the end of its travel.
- Close the door.

Fuse holder door

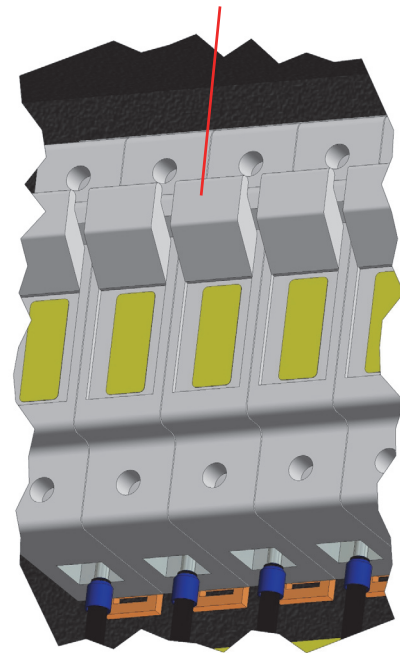

9.2 Replacement of the SSR module

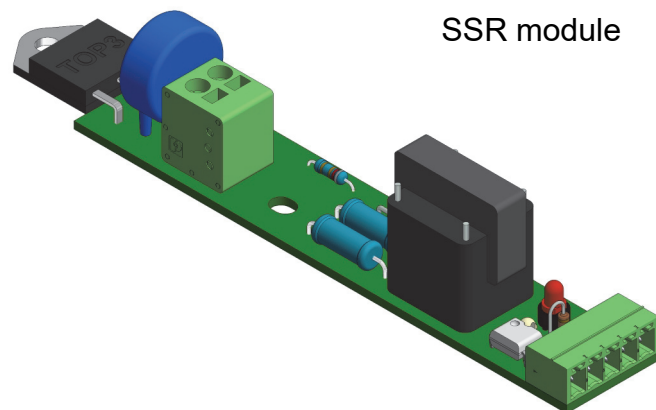

- Safely disconnect the equipment from the power supply.
- Open the door with the appropriate key provided.
- Remove the plexiglass cover to protect the SSR modules using a 4 mm hexagonal key, as shown in the figure below:

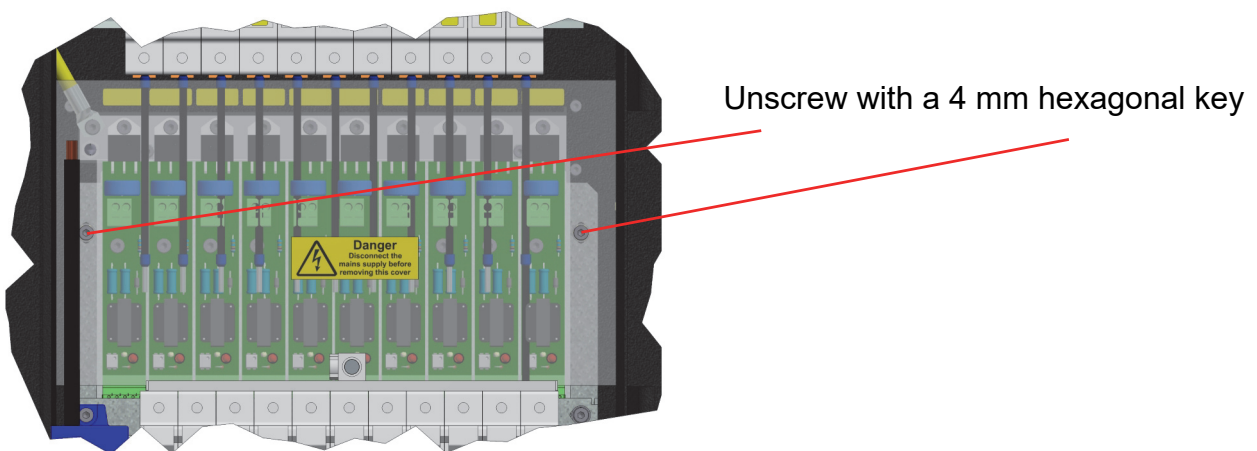

- Disconnect the two wires from the terminal block of the SSR module. For this operation, use a flat-blade screwdriver (recommended blade size 3.5 x 0.6 mm), type Phoenix Contact SZF 1-0.6X3.5 - 1204517 or equivalent. Insert the blade into the appropriate seat of the terminal board and extract the cable. Mark the cables to avoid inverting them during wiring.

- Unscrew the two fixing screws of the defective SSR module using a 4 mm hexagonal key, as shown in the following image:

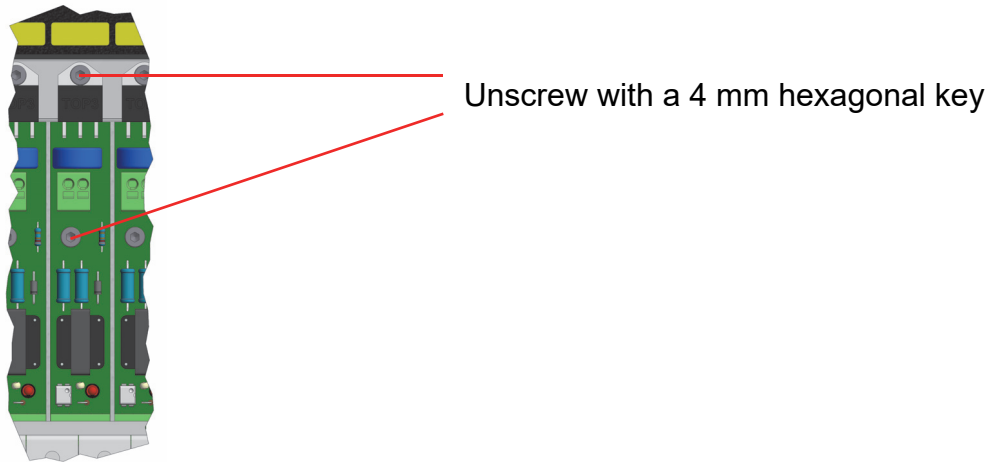

- Remove the SSR module by sliding it upwards, disengaging it from the green interface connector with the CPU board. Be careful not to pry up the connector to avoid damaging it, but try to pull it out horizontally.
- Remove the old layer of thermoconductive paste on the aluminum bar below, and replace it with a thin and uniform layer of thermoconductive paste (available on request).
- Fit the replacement module by inserting the connector fully.
- Reposition the fixing screws in place; sprinkle the stem of the upper fixing screw (the one that fixes the tab of the electronic component to the fixing plate) with medium-type Loctite 243 type brakes or equivalent. Tighten the screws with a torque tool to a torque of $1.0 \text{ Nm} \pm 10\%$.
- Reconnect the connection cables in reverse order of disassembly.
- Reposition the plexiglass protection and fix it with the appropriate screws; tighten the screws with a torque tool to a torque of $0.5 \text{ Nm} \pm 10\%$.
- Close the door.

9.3 Assembly of additional ventilation kit

- Safely disconnect the equipment from the power supply.
- Unscrew the plastic ring nut from the cable gland and take out the internal sealing rubber. It has four blind guide holes; using a pointed object (eg a PH0 cross-head screwdriver) to make the through holes to allow the passage of the fan cables.
- Screw the four spacers into the appropriate holes provided in the heatsink using a 7 mm hexagonal key, tightening them to a torque of $1.5 \text{ Nm} \pm 10\%$.

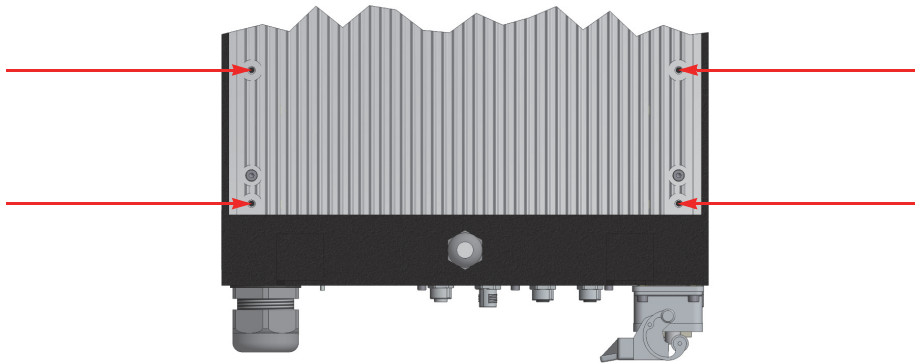

Fixing holes

- Position the fan support at the holes in the spacers.
- Tighten the four fixing screws interposing the supplied Grover washer and tighten them to a torque of $1.5 \text{ Nm} \pm 10\%$ using a 2.5 mm hexagonal tool.

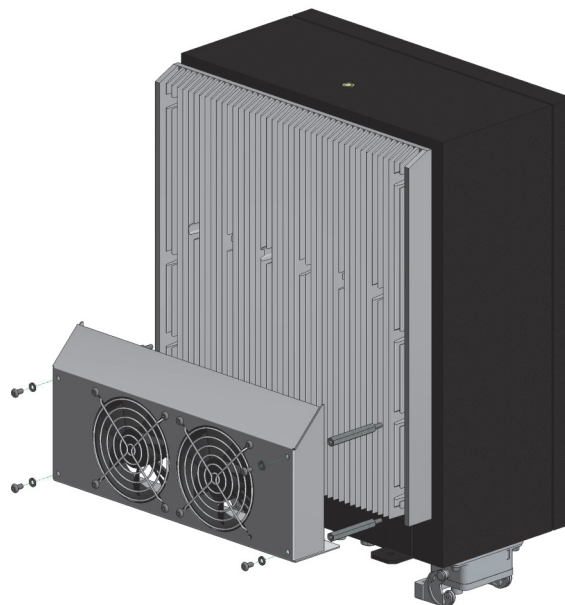

Assembly of ventilation kit

- Fit the cable clamp ring nut on the cables and insert them into the holes in the cable gland. Refit the rubbers and ring nut, adjusting the distance of the cables that come out according to your needs.
- The cables of the two fans must be wired in the two spring-loaded terminal blocks shown in the following image. Adjust the length of the cables appropriately.

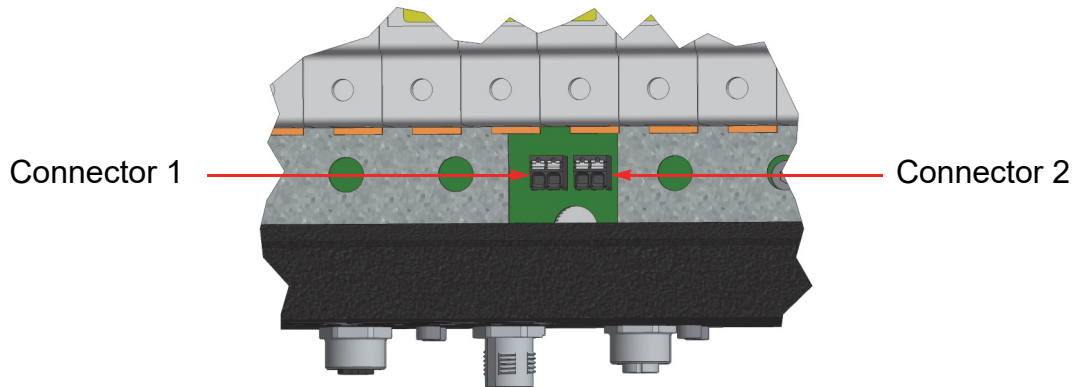

Connectors for wiring ventilation kits

- Strip the cables for a length of 8 mm. Wire the cables in the terminal board respecting the indicated polarity; to open the terminal board contacts, press the levers using a flat blade screwdriver (recommended blade size 2.5 x 0.6 mm), type Phoenix Contact SZS 0.4X2.5 - 1205037 or equivalent.
- Close the door.

9.4 Periodic maintenance - Clamping of fuse terminals

Tighten the power terminals at least every six months using the tightening torques and the tools shown in the figure.

9.4.1 Model without current distributor

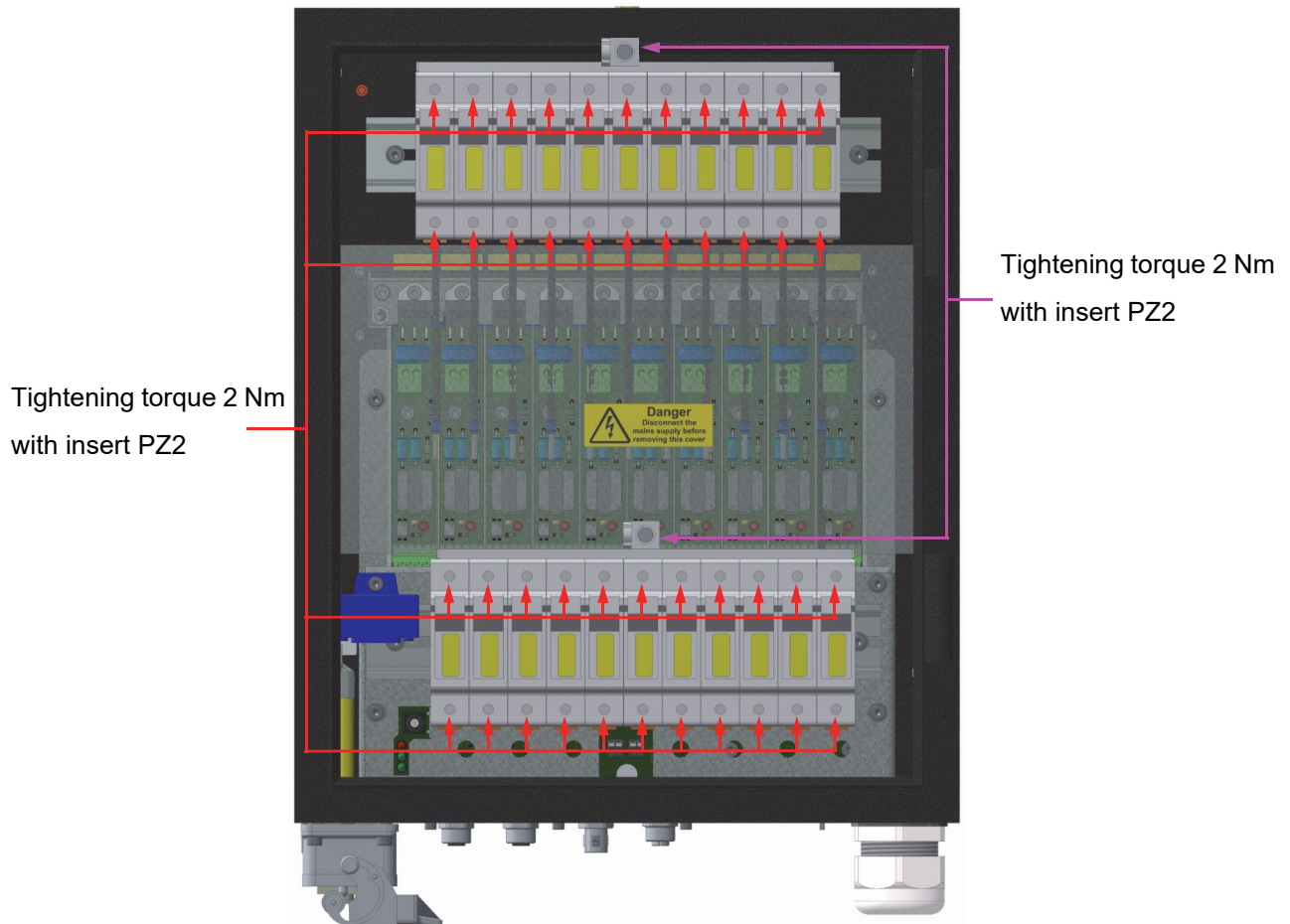

9.4.2 Model with current distributor

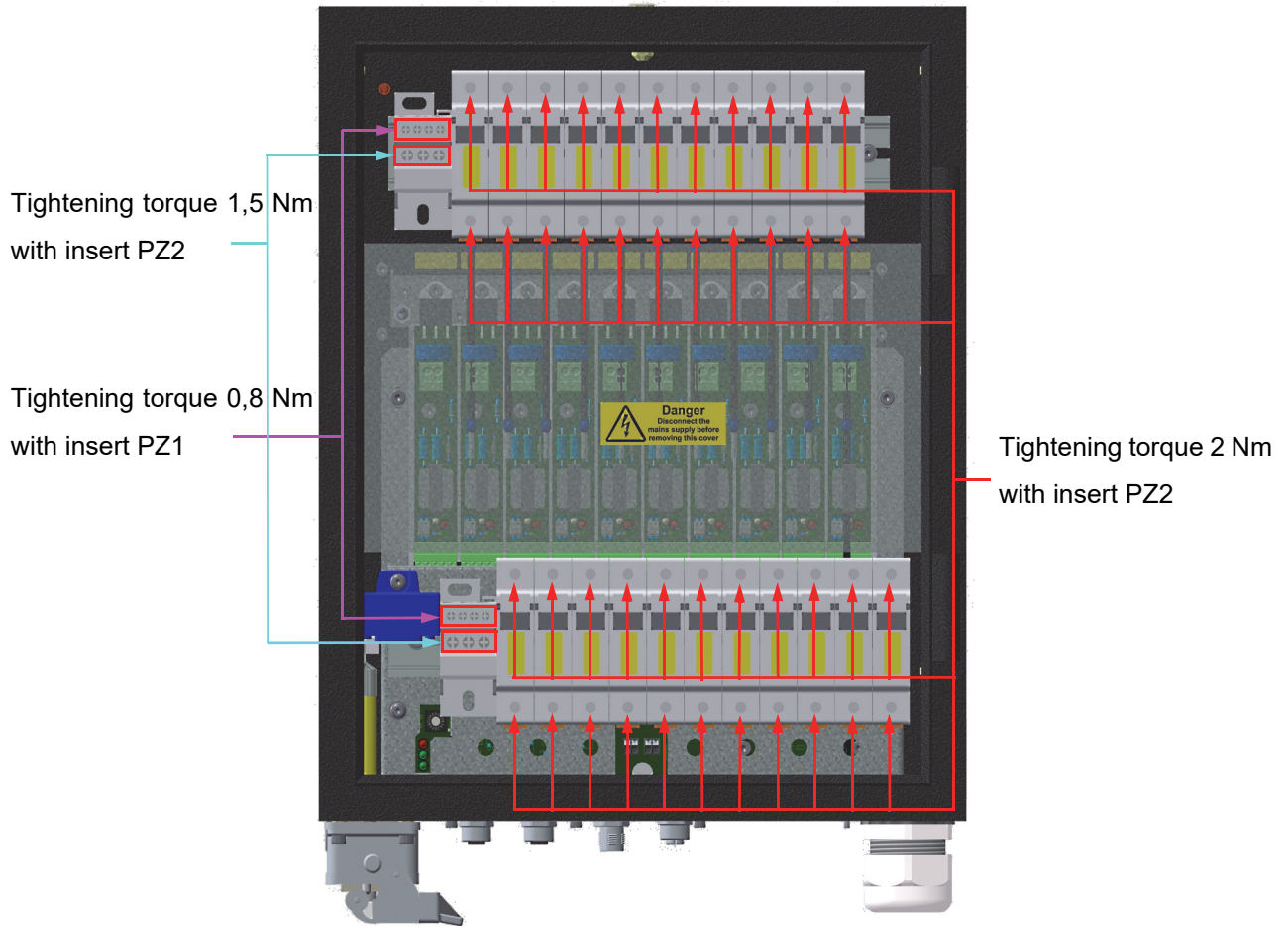

	<p>Before tightening all the terminals of the fuse holders, always make sure to remove power supply from the device.</p>
	<p>Failure to perform maintenance can cause risk of device failure.</p>

10 Disposal and demolition

The disposal of this device must be carried out according to the laws in force in the country where it was installed. Should the disposal be partial (frame, heat sink, electronic boards), separate the components made of plastic from the components made of aluminium, etc. Their disposal must be in compliance with the law in force in the country where the device was installed.

11 Analytical index

Numerics

24VDC 23, 28

A

Accessories 11
Addressing 24
Assembly 6

C

Clamping 39
Commissioning 12
Connections 16
Current main 9

D

Danger 4
Demolition 41
Derating 8
Diagnostics 31
Dimensions 10
Disposal 41

E

Electrocution 7
Electromagnetic compatibility 20

F

Fieldbus 20, 24
Firmware upgrade 33
Fixing 13
FLxIO 20, 31
Fuse holder door 34

H

Handling 6
Hot parts 7

I

Installation 12
IP65 8
IR lamp 33

K

Key seat 26
Key supplied 26

L

Lamp pilot 9

M

Maintenance 34

O

Operating temperature 8
Operation 31

P

Positioning 13
Power consumption 9
Power output 28
Power supply 9, 17

R

Residual risks 7
RS485 31

S

Safety 6
SSR module 35
Storage 32
Switch 26

T

Tightening torque 39
TRIAC 31

V

Ventilation kit 16, 37

W

Warnings 4
Weight 10