

Smitec S.p.A., via Carlo Ceresa 10, 24015 San Giovanni Bianco (BG), Italy, [www.smitec.it](http://www.smitec.it)



## Installation, use and maintenance manual



**BEFORE STARTING UP THE POSYC 430X SERIES INDUSTRIAL PCS, CAREFULLY READ THIS MANUAL AND FOLLOW ALL INSTRUCTIONS, IN ORDER TO ENSURE MAXIMUM SAFETY**

# INDUSTRIAL COMPUTERS

## POSYC 4301/4302/4303



The technical data and the drawings in this manual might have been modified later; always refer to the latest version.

## Summary

<b>1 Preface</b> .....	<b>4</b>
<b>2 General warnings</b> .....	<b>5</b>
<b>3 Safety instructions</b> .....	<b>7</b>
3.1 General information .....	7
3.2 Precautions during handling and assembly .....	7
<b>4 Product description</b> .....	<b>8</b>
<b>5 Technical data</b> .....	<b>10</b>
5.1 Environmental specifications .....	10
5.2 Electrical characteristics .....	10
5.3 Mechanical characteristics .....	11
5.3.1 Mechanical dimensions .....	11
5.3.1.1 Front view .....	11
5.3.1.2 Side view .....	12
5.3.1.3 Rear view .....	13
5.3.1.4 Rear view (recommended panel cut) .....	13
5.4 Hardware features .....	14
5.4.1 Basic hardware common to the POSYC 430X family .....	14
5.4.1.1 Model POSYC 4301 "Open type UL" .....	15
5.4.1.2 Model POSYC 4302 "Open type UL" .....	15
5.4.1.3 Model POSYC 4303 "Enclosed type UL" .....	15
5.5 Order codes .....	15
5.6 Accessories .....	16
<b>6 Connections and LEDs</b> .....	<b>17</b>
6.1 24V IN connector .....	19
6.2 RS485 serial port - COM1 .....	21
6.3 RS232 serial port - COM2 .....	21
6.4 Profibus card .....	22
6.5 Ethernet ports .....	22
6.5.1 LED behavior of communication speed signaling .....	23
6.5.2 LED behavior for signaling connection and communication activities .....	23
6.6 CFast card connector .....	23
<b>7 Installation</b> .....	<b>24</b>
7.1 Panel mounting .....	24
7.2 Assembly in dedicated body .....	25
7.3 Environmental requirements .....	26
7.4 Electrical connections .....	27
7.4.1 Wiring standard RS232 serial ports .....	27
7.4.2 RS485 serial ports wiring .....	27
7.4.3 Profibus DP port wiring .....	28
7.4.4 Serial signals RS485, Profibus DP .....	30
<b>8 Use</b> .....	<b>31</b>
8.1 Touch screen .....	31
8.2 Front USB ports .....	31
8.3 CFast card .....	32
8.4 Boot devices priority .....	33
<b>9 Ordinary maintenance</b> .....	<b>34</b>
9.1 Cleaning the touch screen sensor .....	34
9.2 Replacing the clock battery .....	34
9.3 CFast replacement .....	35
<b>10 Appendices</b> .....	<b>36</b>
10.1 Appendix I: Parameters of the CMOS Setup .....	36
10.2 Appendix II: OS update and/or software installation .....	36

**11 Analytical index ..... 37**

## 1 Preface

This manual provides all necessary information for the installation, use and maintenance of POSYC 430X series industrial PCs.

The instructions included in this manual are addressed to the following professionals:

<b>User</b>	User is a person, a company or an institution that buys the equipment and uses it for the purposes it was designed for.
<b>User/operator</b>	User or operator is a person authorized by the user to operate on the equipment.
<b>Specialized personnel</b>	It refers to all persons with specific competence, able to recognize and avoid the dangers deriving from the use of the equipment.

The present instructions must be made available to all the above individuals.





## 2 General warnings

These assembly instructions are an integral part of the equipment, and must be kept for future reference until decommissioning.

The user should be informed that the present instructions reflect the state of the art at the moment when the equipment was sold; they will remain fully acceptable despite subsequent upgrades based on new experiences.

	<p><b>DO NOT USE THE EQUIPMENT, NOR MAKE ANY INTERVENTION BEFORE INTEGRALLY READING AND UNDERSTANDING THIS MANUAL.</b></p>
<p><b>IN PARTICULAR, ADOPT ALL SAFETY PRECAUTIONS AND PRESCRIPTIONS INDICATED IN THIS MANUAL.</b></p>	
<p><b>THE EQUIPMENT CANNOT BE USED FOR PURPOSES DIFFERENT THAN THE ONES DESCRIBED IN THIS MANUAL; SMITEC S.p.A. SHALL NOT BE HELD RESPONSIBLE FOR ANY DAMAGES, INCONVENIENCES OR ACCIDENTS DUE TO THE NON-COMPLIANCE WITH THESE PRESCRIPTIONS.</b></p>	

In order to make the manual consultation easier, the following symbols have been adopted:



	<p>Indication of "PROHIBITED ACTION".</p>
	<p>The symbol "DANGER" is used when the non-respect of the prescriptions or the tampering of organs can cause serious harm to people or things.</p>
	<p>The symbol "USE OF INDIVIDUAL PROTECTIONS" means that protective gloves must be worn.</p>
	<p>Indication of "INFORMATION OF PARTICULAR RELEVANCE".</p>

The safety prescriptions aim at establishing a series of behaviors and obligations to be complied with, while performing the activities described later on in this manual.



These prescriptions constitute the prescribed method of operating the device, in a way that is safe for personnel, equipments and environment.

### 3 Safety instructions

#### 3.1 General information

	<p>Do not install or use the equipment before integrally reading and understanding this manual. In case of difficulties of interpretation, contact SMITEC technical service.</p> <p>It is absolutely forbidden to use the equipment for different purposes than the ones described in this manual. The technical data and the drawings in this manual might have been modified later; always refer to the latest version. All upgrades can be requested to SMITEC S.p.A. directly.</p>
	<p>Make sure that the personnel is qualified and adequately informed about the risks he may run and how to avoid them.</p>
	<p>POSYC 430X series industrial PCs can be used only after the classification of the machine operating area and after checking the safety levels, which must correspond to the assembly safety levels.</p>

#### 3.2 Precautions during handling and assembly

	<p>Use adequate tools during the assembly, in order to avoid crushing or abrasions.</p>
	<p>Metal components and sharp surfaces may cause cuts and tears. In case of contact, be very careful and wear the personal protection equipment.</p>

## 4 Product description

The POSYC is a personal computer based on Intel®64 architecture designed primarily to facilitate human-machine interfacing (HMI) in an industrial environment, but its characteristics make it suitable also for different uses, such as information terminals and automation systems in general.

The user interface mainly uses a flat color display and a touch screen pointing system integrated into the product.

The 15-inch LED-illuminated TFT liquid crystal display with a diagonal dimension of 15" offers a considerable display area, great brightness, color brilliance and a good viewing angle.

The touch screen system offers features of robustness and ease of use, difficult to obtain with other common pointing devices such as mouse, track-ball and mouse pad.

Being completely integrated into the appliance, it is particularly suitable even in industrial applications that require resistance to external agents such as dust, humidity, water, oils, etc., which would be harmful for standard devices.

Since it is sufficient to exert a slight pressure with a finger on its surface to make an immediate pointing, this system is the main "User Friendly" feature of the POSYC computer.

In order to meet the most different interfacing needs, POSYC nevertheless provides the possibility to connect also standard input/output devices, such as keyboard, mouse, track-ball, monitor, etc.

In its minimum configuration, the POSYC can communicate with the outside world via 1 standard RS232 serial port and 1 RS485 port; it also offers 4 standard USB 3.0 ports, 2 IP65 USB 2.0 ports on the front, 2 10/100 / 1000Mb Ethernet ports, 1 HDMI port and 1 DVI-D port.

Depending on the version, a profibus card may be available in addition to the basic hardware of the POSYC 430X series.

The POSYC calculation capability is given by the Intel® Celeron™ N3160 processor, Quad-Core, 1.6GHz with 4GB SDRAM DDR3L memory.

The storage of data and programs on non-volatile support is entrusted to a 32GB CFast card (high-speed flash memory). The position of the device inside the POSYC is such that it can be extracted without opening it. The main advantage of the CFast card is its exceptional resistance to accidental shocks and vibrations.

The new design makes it particularly attractive even for non-industrial applications.





POSYC 4303 with Emkey body

## 5 Technical data

	<p>All the technical information reported in this section are consistent with the hardware configuration of the POSYC computer produced at the date of writing of this document. With the aim of improving or updating the product technologically, SMITEC S.p.A. reserves the right to change the technical features of the POSYC computer without notice.</p>
---	---

### 5.1 Environmental specifications

<b>Operating temperature</b>	0° ÷ 50°C: panel mounted 0° ÷ 45°C: when operating with a dedicated body KG020082/4
<b>Storage temperature</b>	-20° ÷ +60°C (when not operational)
<b>Relative humidity</b>	0 ÷ 90% (without condensation)
<b>Protection degree</b>	IP65 or "UL type 1" (panel mounted or with dedicated body)
<b>Maximum altitude</b>	2000 m a.s.l

### 5.2 Electrical characteristics

The following characteristics refer to the standard POSYC computer load as supplied, without any connected peripheral device.

<b>Main power supply voltage</b>	24 VDC (-15% ÷ + 20% according to EN 61131-2) from CLASS 2 power supply (UL)
<b>Current consumption</b>	Max 1.25A @ 24VDC
<b>Absorbed power</b>	Max 30.0W

### 5.3 Mechanical characteristics

<b>Fixing</b>	6 M5 threaded holes
<b>Weight</b>	5.1 - 5.2 kg (depending on the model)

#### 5.3.1 Mechanical dimensions

##### 5.3.1.1 Front view

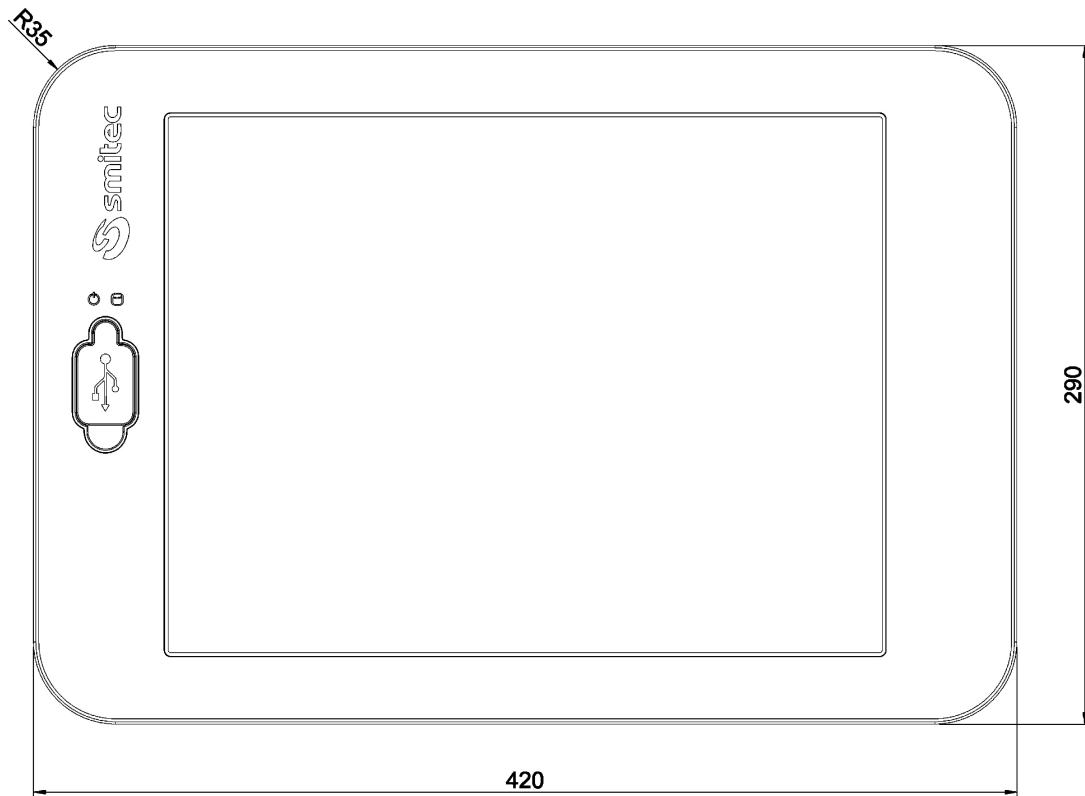

5.3.1.2 Side view

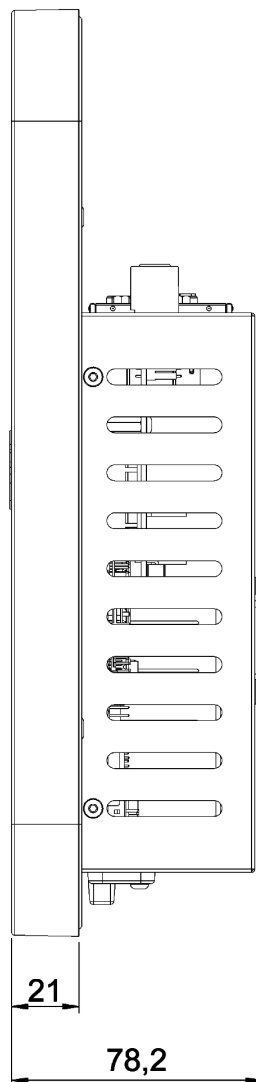

5.3.1.3 Rear view

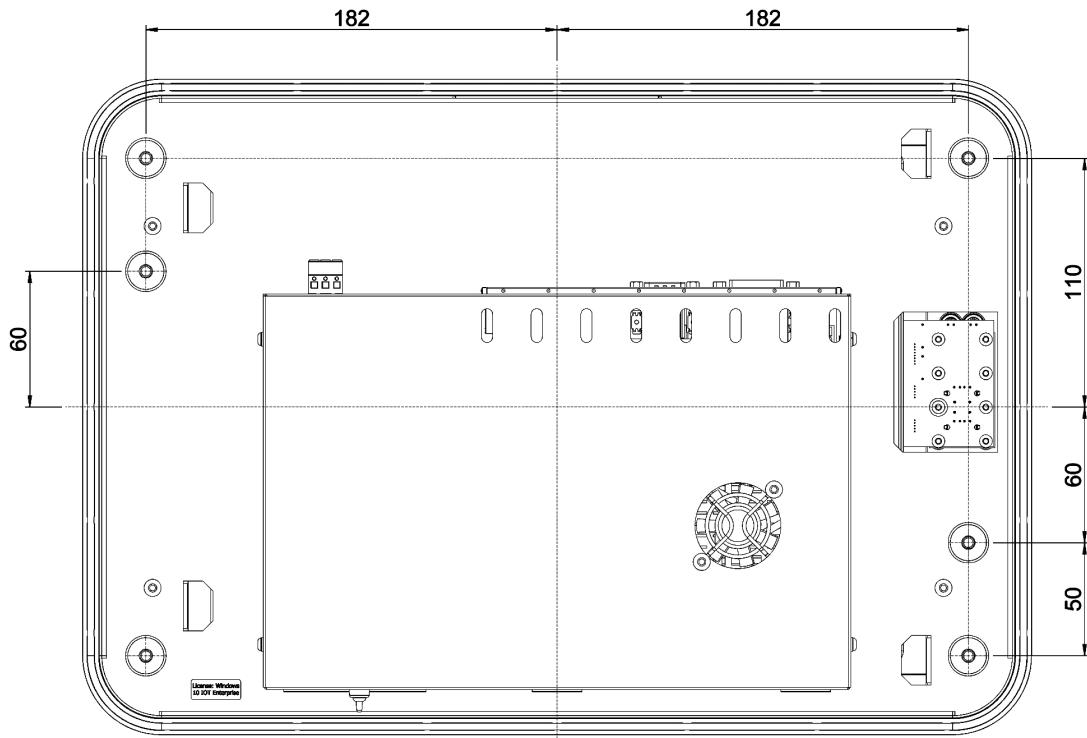

5.3.1.4 Rear view (recommended panel cut)

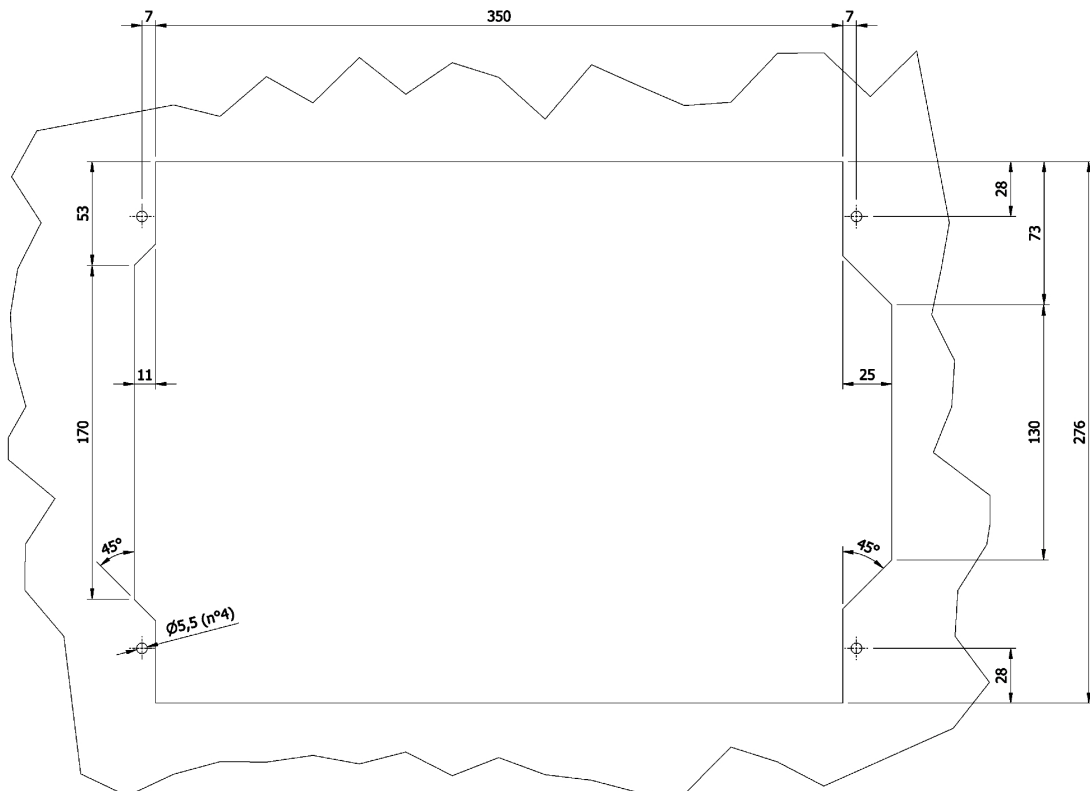

## 5.4 Hardware features

	<p>The hardware whose features are described is the minimum guaranteed in the product and functionally tested; some peripherals possibly present in addition to the purchased product are not guaranteed neither for production continuity nor for functionality.</p>
---	---

### 5.4.1 Basic hardware common to the POSYC 430X family

<b>Processor</b>	Intel® Celeron™ N3160, Quad-Core, 1.6GHz, 2.8GHz Burst
<b>Memory</b>	4GB SODIMM DDR3L 1066MHz SDRAM
<b>CFast card</b>	32GB - 530 MB/s read, 210 MB/s write
<b>Display</b>	15" color LED TFT, 1024x768, 16.2M colors
<b>Touch screen sensor</b>	5 resistive wires
<b>Touch screen controller</b>	Serial on COM4
<b>Serial port COM1</b>	RS485 not isolated
<b>Serial port COM2</b>	RS232C
<b>External monitor port</b>	DVI-D
<b>Rear USB ports</b>	4 x 3.0
<b>Front USB ports</b>	2 x 2.0
<b>Ethernet ports</b>	2 x Gigabit LAN
<b>Audio - Video</b>	HDMI

**5.4.1.1 Model POSYC 4301 "Open type UL"**

Basic hardware common to the POSYC 430X family

**5.4.1.2 Model POSYC 4302 "Open type UL"**

Basic hardware (POSYC 4301) with the following additions:

<b>Profibus interface card</b>	1 on PCI EXPRESS bus
--------------------------------	----------------------

**5.4.1.3 Model POSYC 4303 "Enclosed type UL"**

Basic hardware (POSYC 4301) with the following additions:

<b>Blind body</b>	Code KG020084
<b>Emkey body</b>	Code KG020082

**5.5 Order codes**

Order code	Model	Description
KZ010519	4301	POSYC 4301 - Basic Hardware -
KZ010520	4302	POSYC 4301 + profibus board (code KS030070; manufacturer: Molex)
KZ010733		POSYC 4301 + profibus board (code KS030087; manufacturer: Hilscher)
KZ010522	4303	POSYC 4301/4302 + blind body
KZ010569		POSYC 4301/4302 + Emkey body

## 5.6 Accessories

POSYC 430X industrial computers are supplied with power connector, mass storage and W10 IOT Enterprise license. The same can be ordered separately as well as other accessories not included in POSYC.

Below is the list of order codes:

Order code	Article
KF100038	24VDC connector (Phoenix Contact 1713842) *
KE020031	32GB CFast card empty
KE050070	System CFast card and NTFS with s.o. W10 IOT *
KE050095	CFast system card and NTFS with s.o. W10IOT per cod. KZ010520 *
KE050129	CFast system card and NTFS with s.o. W10IOT per cod. KZ010733 *
TB010554	CR2032 Lithium 3V button battery *
KG020084	POSYC body with VESA fixing without paneling
KG020082	POSYC body with VESA fixing + control panel body
KZ010334	Push-button panel EMKEY 4001 (VAR.0) without body with white key, black key, illuminated blue key, emergency key
KZ010477	Push-button panel EMKEY 4001 (VAR.3) without body with green key, red key, illuminated blue key, emergency key
KZ010544	Push-button panel EMKEY 4001 (VAR.1) without body with illuminated white key, red key, illuminated yellow key, emergency key
KZ010545	Push-button panel EMKEY 4001 (VAR.2) without body with white key, black key, blue key light, emergency key
KZ010570	Push-button panel EMKEY 4001 (VAR.2) "Enclosed Type UL", complete with body and connection kit to the Posyc 4000 body Features as per push-button panel KZ010545
MA117784	Spacer for POSYC fixing to the body *
MA903498	Dust cap front USB ports *
MF101475	Frontal seal with 3.0mm diameter (1,5m) *

\* = Supplied with POSYC



## 6 Connections and LEDs

Almost all the connectors are on the upper part of the POSYC together with the LED that indicates the presence of the 24V, as shown in the following figures.

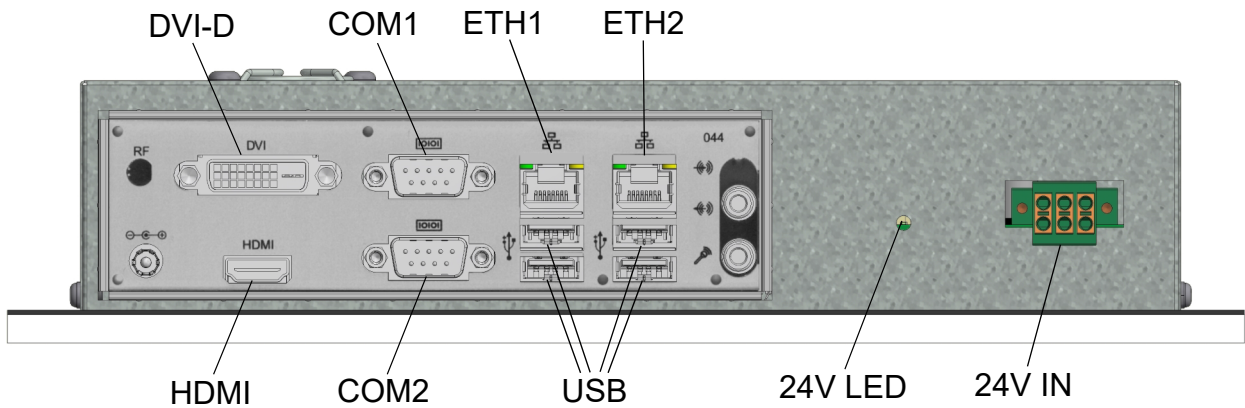

POSYC 4301 top panel view

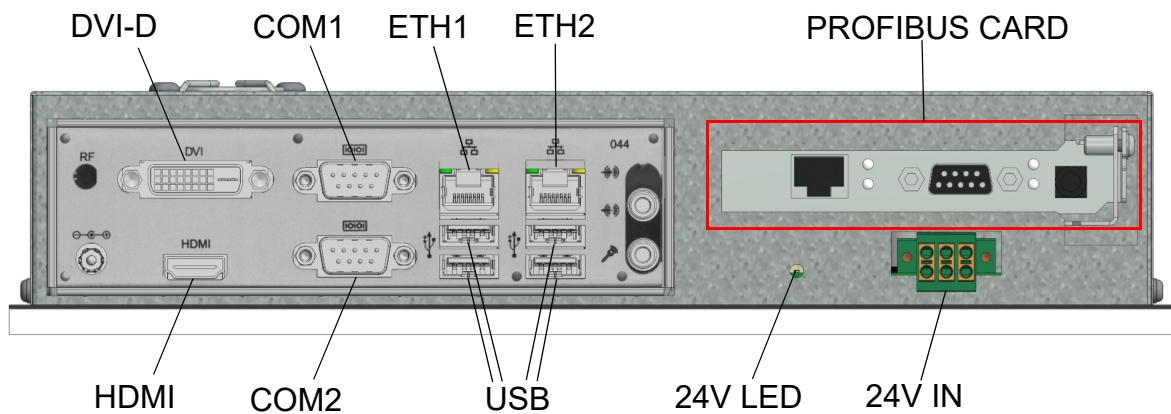

POSYC 4302 upper panel view

Name	Function
COM1	RS485 serial communication port
COM2	RS232 serial communication port
DVI-D	Digital video port for external monitors
ETH1	RJ45 Ethernet communication port
ETH2	RJ45 Ethernet communication port
USB	4 x USB 3.0 port
HDMI	HDMI audio / video interface port

24V LED	Green LED indicating 24V power supply presence
24V IN	24V power supply connection
PROFIBUS (only POSYC 4302)	Profibus card

There are 2 USB connectors on the front panel and a reset button, protected by a rubber stopper, and 2 signaling LEDs, as shown in the following figure.

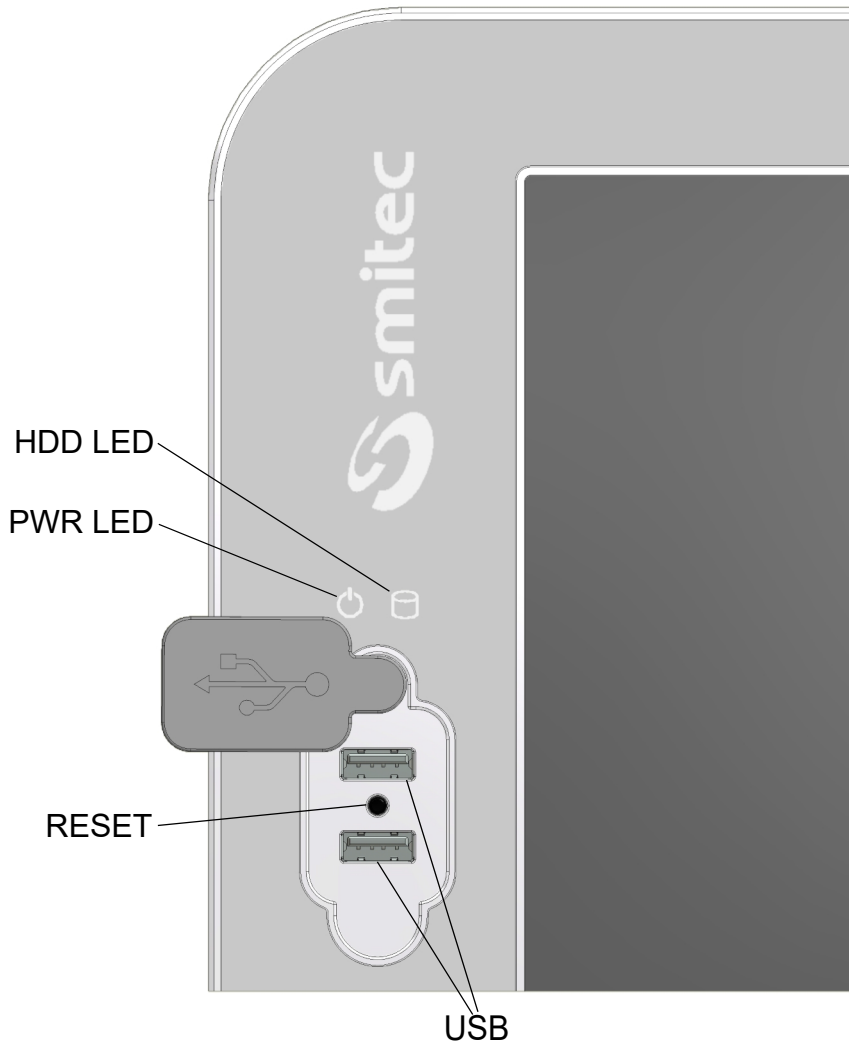

Name	Function
USB	2 x USB 2.0 port
HDD LED	White LED signaling activity CFast
PWR LED	POSYC white LED indicator on
RESET	Reset button

6.1 24V IN connector

Connector type: Phoenix Contact TVFKC 1,5/3-ST (1713842) * **				
Order code: KF100038				
Features		Conductors cross section		
Connection in accordance with	EN-VDE	Solid min.	0,2 mm <sup>2</sup>	24 AWG
Rated voltage	250 V	Solid max.	1,5 mm <sup>2</sup>	16 AWG
Rated current	10 A	Stranded min.	0,2 mm <sup>2</sup>	24 AWG
		Stranded max.	1,5 mm <sup>2</sup>	16 AWG
Insulating material	PA	Stranded, with ferrule without plastic sleeve min.	0,25 mm <sup>2</sup>	24 AWG
Inflammability class according to UL 94	V0	Stranded, with ferrule without plastic sleeve max.	1,5 mm <sup>2</sup>	16 AWG
Stripping length	8 mm	Stranded, with ferrule with plastic sleeve min.	0,25 mm <sup>2</sup>	24 AWG
Screwdriver to be used for opening the connections	0,6 x 3,5 mm	Stranded, with ferrule with plastic sleeve max.	1,5 mm <sup>2</sup>	16 AWG
*= Use only 75°C cables				
**= Use only copper conductors				

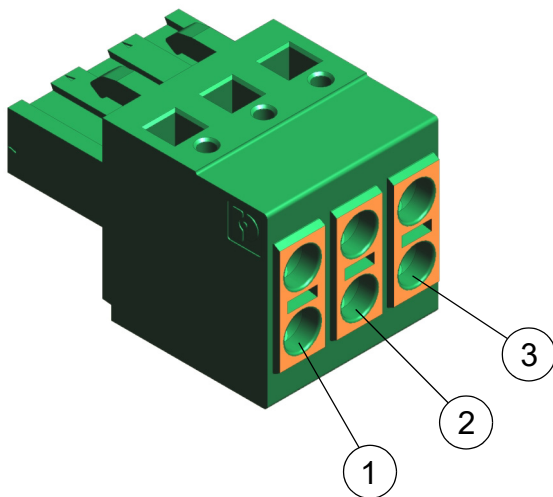

Supply 24V	
Pin	Signal
1	+24 Vdc
2	FE (functional earth)
3	GND

**CAUTION**

	<p>Use a cable with a suitable cross-section, sized correctly according to the through-current. A cable with a section smaller than that required may cause fire due to overheating phenomena generated by the cable itself.</p>
	<p>To ensure compliance with the EMC 2014/30 / EU directive, the length of the cables must not exceed a length of 30 meters.</p>
	<p>The POSYC 430X is a high-tech electronic device, sensitive to electrostatic discharge (ESD) phenomena. Pay the utmost attention to prevent such phenomena, complying with the provisions of the law, in order to avoid damage to the device.</p>

**ATTENTION**

	<p>Utilisez un câble de section appropriée, dimensionné correctement en fonction du courant traversant. Un câble de section inférieure à celle requise peut provoquer un incendie en raison de phénomènes de surchauffe générés par le câble lui-même.</p>
	<p>Pour garantir la conformité avec la directive EMC 2014/30 / EU, la longueur des câbles ne doit pas dépasser 30 mètres.</p>
	<p>Le POSYC 430X est un appareil électronique de haute technologie, sensible aux phénomènes de décharge électrostatique (ESD). Faites très attention à ce que ces phénomènes ne se produisent pas, dans le respect des dispositions légales, afin d'endommager l'appareil.</p>

### 6.2 RS485 serial port - COM1

Below is the pinout of the DB9 male connector on the POSYC.

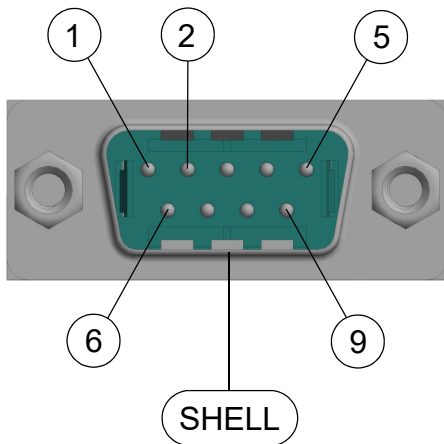

Serial RS485 - COM1	
Pin	Signal
1	DATA-
2	DATA+
5	GND
SHELL	CABLE SCREEN

### 6.3 RS232 serial port - COM2

Below is the pinout of the DB9 male connector on the POSYC.

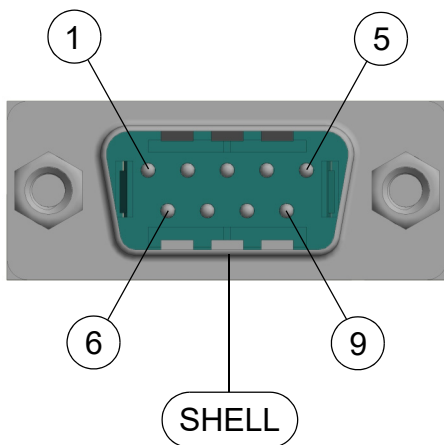

Serial RS232 - COM2	
Pin	Signal
1	NC
2	RD
3	TD
4	NC
5	GND
6	NC
7	NC
8	NC
9	NC
SHELL	CABLE SCREEN

### 6.4 Profibus card

Below is the pinout of the DB9 female connector on the POSYC.

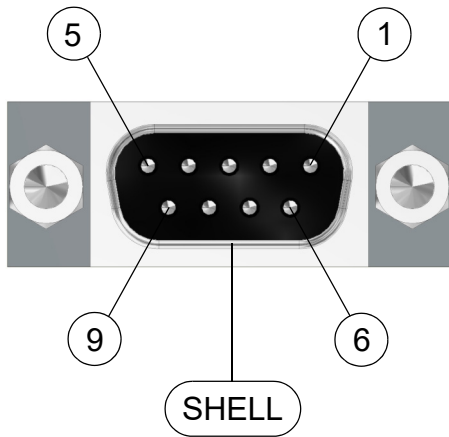

Profibus port DB9	
Pin	Signal
3	DATA+
5	GND
6	VP
8	DATA-
SHELL	CABLE SCREEN

### 6.5 Ethernet ports

There are two 10/100/1000 Mbps Ethernet ports that use standard RJ45 Ethernet connectors.

The two RJ45 connectors on the POSYC are shown below:

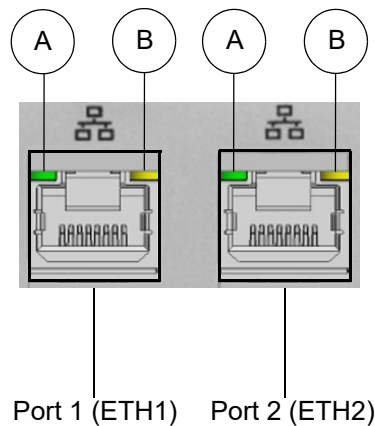

Each of the two Ethernet ports has two LEDs. The first, distinguished by the letter A, indicates the communication speed of the port involved. It is a two-color LED (green / orange); according to the speed at which the Ethernet port is communicating, the LED takes on a different color. The second, yellow, marked by the letter B, indicates the state of activity of the gate itself, or if the gate is connected or if it is communicating.

**6.5.1 LED behavior of communication speed signaling**

Below is a table that summarizes the possible speed states of Ethernet port:

Name	State	Function
A	OFF	Ethernet port communicating at a speed of 10 Mbps
A	ON (Green LED)	Ethernet port communicating at a speed of 100 Mbps
A	ON (Orange LED)	Ethernet port communicating at a speed of 1 Gbps

**6.5.2 LED behavior for signaling connection and communication activities**

Name	State	Function
B	OFF	Ethernet port not connected
B	BLINK OFF (Yellow LED)	Ethernet port connected and communicating

**6.6 CFAST card connector**

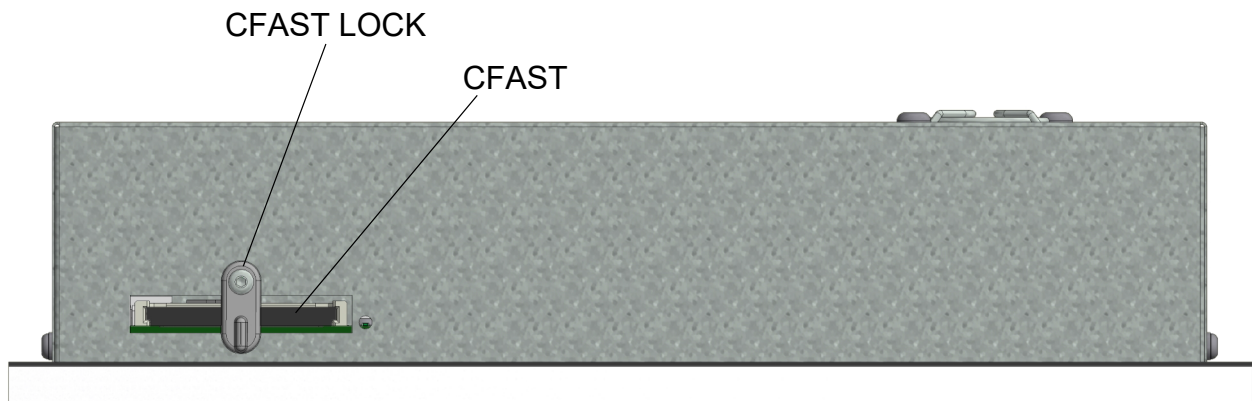

At the bottom of the POSYC is the connector for the CFAST card. The memory is secured inside the computer via a locking lever.



Bottom panel view

Name	Function
CFAST	Connector for CFAST memory card
CFAST LOCK	Lock lever

## 7 Installation

	<p>During installation of the POSYC 430X computer, falls and violent shocks must be avoided which could compromise the smooth operation.</p>
	<p>Avoid touching the input / output connectors on the computer panel directly unless you are equipped with suitable static electricity protection equipment; any discharges on the connectors could damage the appliance.</p>
	<p>Since the front panel integrates the touch screen sensor, violent blows in addition to damaging it irreparably could bring to light cut-glass shards, therefore dangerous for the operator.</p>
	<p>Always carry out all electrical connections when the equipment is switched off: this will prevent damage to the computer and danger to the operator (exceptions to connections to the USB ports are possible).</p>
	<p>Always make sure that all the devices connected to the POSYC have an efficient grounding (if foreseen by the device). Failure to follow this precaution could result in damage to the computer and danger to the operator.</p>
	<p>Do not position the device so that it is difficult to disconnect the wiring connected to it.</p>

### 7.1 Panel mounting

The POSYC can be mounted on the panel by preparing the recommended cut on a panel that is strong enough to support its weight and to remain flat once the computer is fixed. A lack of flatness or a wrinkled surface of 3.2µm can compromise the effectiveness of the round gasket installed in the POSYC frame.

For fixing use 4 stainless steel 4xM5x12mm screws, tightened to 3 Nm (not supplied); depth of threaded holes in the 10mm frame.



## 7.2 Assembly in dedicated body

The POSYC can be mounted in one of the two dedicated aluminum frames (for the order codes see specific chapter).

Both have a predisposition for the attachment to a support arm with standard dimensions and holes "VESA MIS-D, 100, T". To fix the body to the arm, then use four M4x10mm steel screws (not supplied).

Prepare the POSYC by screwing the MA117784 spacers (supplied with the computer) into the four holes at the corners of the frame. A 6mm spanner wrench is required for tightening.

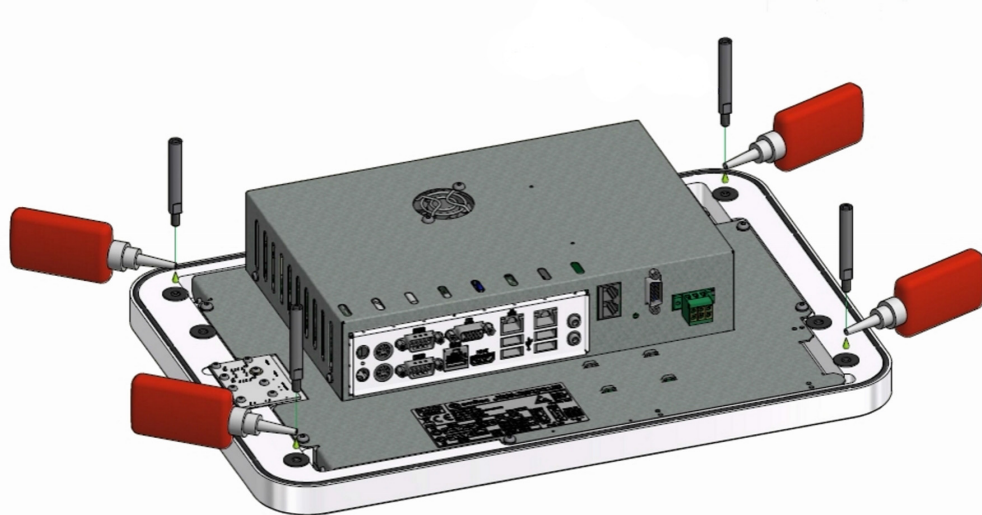

Slip the POSYC to the body by sliding the spacers in the appropriate seats of the same and secure it by screwing the two M5x60mm screws (MF300543 supplied together with the body) into the intermediate holes, tightened to 3 Nm. To hold it tight, screw the four M5x10mm screws (MF300168 supplied together with the body) into the holes in the corners, tightened to 3 Nm.

Then, to inspect the connections and the CFast without completely releasing the computer from the body, remove the four screws at the corners and take advantage of the sliding of the spacers.

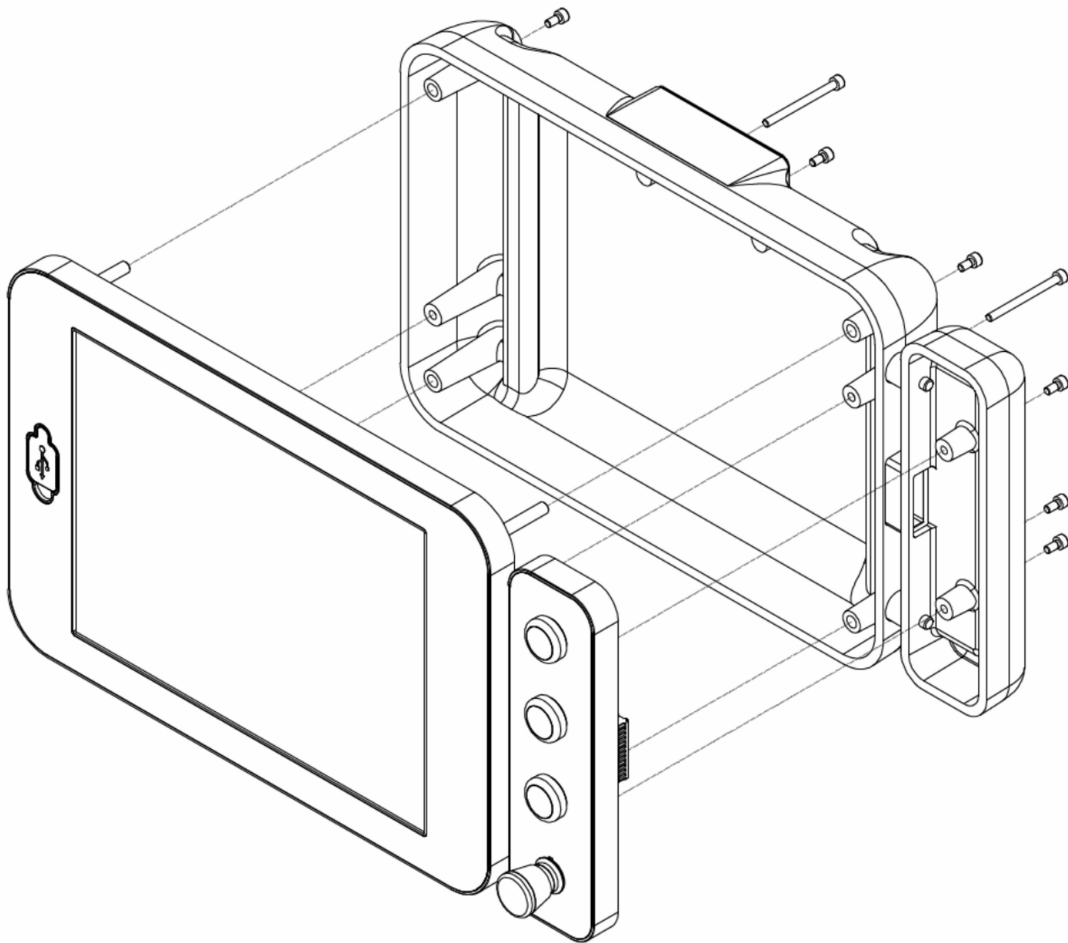

Example of assembly in a dedicated body with a push-button panel

### 7.3 Environmental requirements

The POSYC is designed to be placed in a container that gives it protection from water and dust that could damage it.

The internal cooling of the POSYC takes place through the air sucked at the rear by a high-speed fan; in order for the system to work properly it must remain within the room temperature limits given in the specifications.

All this implies that inside the panel that will contain the POSYC, there must be suitable conditioning systems to keep the temperature within the accepted limits.

The dedicated bodies are designed not to exceed the maximum temperature accepted by the POSYC and therefore do not require any other precautions.

## 7.4 Electrical connections

The essential connections for POSYC operation are power and ground; make these two connections by following the polarity, conductors and connectors indicated in the “Connections” chapter. Before switching on the appliance, check that the power supply voltage is within the parameters specified.

The connection of POSYC to peripherals is simplified by the use of standard computer connectors; this means that all standard peripherals for personal computers can be connected via the cable supplied with them or in any case with easily available commercial cables.

In the case of connection of non-standard devices for personal computers such as inverters or other and you need combinations of signals and lengths of customized cables, you can make yourself what you need based on the information provided in the chapter “Connections”.

The following are some recommendations on how to make the cabling for serial communication.

### 7.4.1 Wiring standard RS232 serial ports

This type of connection can only connect two devices and the wiring can be made with a variable number of conductors depending on the needs.

According to the specifications of the RS232 standard, the maximum cable length is 15mt at a transmission speed of 20kbps. Please note that the cable length is inversely proportional to the communication speed.

The pairs of twisted conductors are normally used to carry a given signal and its reference (for example TD and GND); the GND connection between the devices is essential for correct operation.

	<p>It is good practice to connect the shield of the cable used only at one end (preferably from the computer side) to avoid differences in potential between the two devices creating a current circulation on the wiring screen, thus introducing communication disturbances; in some applications it is however possible to connect to both ends. The non-connection of the screen to the ground instead (disconnected from both ends) nullifies the function of the screen itself.</p>
---	---

### 7.4.2 RS485 serial ports wiring

The typical use of RS485 ports is in multipoint configuration, or more devices connected to each other; this type of connection exploits a single pair of conductors and from this it follows that the communication is of the half-duplex type.

Through the RS485 serial ports, up to 32 devices (including the master) can be connected in a single section, offering good noise immunity and a maximum transmission speed.

According to the specifications of the RS485 standard the maximum length of the section is 1200mt at a maximum transmission speed of 100kbps. Please note that the length of the section is inversely proportional to the communication speed.

Through appropriate repeater devices (maximum 9) it is possible to extend the connection and connect up to 126 devices.



For correct operation it is necessary to use a suitable cable, terminating it appropriately. The termination consists in connecting at the beginning and at the end of the section of the resistors with a value of 120ohm; for the beginning and end of the section, the master and the most remote slave are considered respectively (called 1 and 4 in the figure below). The length of the cable connecting the intermediate line (called 2 and 3 in the figure below) must be as short as possible (in any case below 1mt), otherwise the signal quality will be lost. The RS485 serial ports of the POSYC have the termination resistors connected internally.

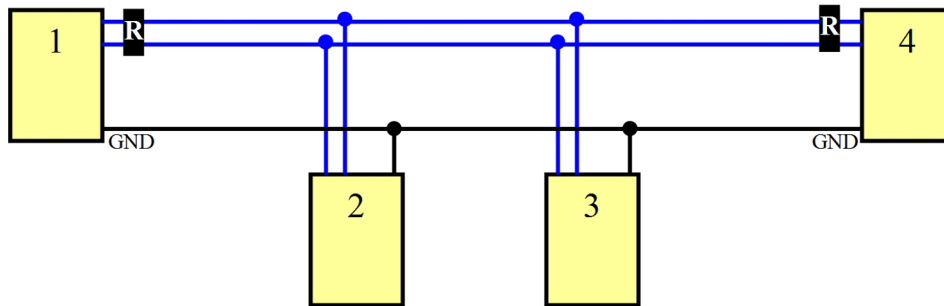

Example of RS485 wiring

An additional conductor with respect to the pair necessary for the communication that connects the masses to each other considerably reduces the probability of failure of the serial ports, especially if they are not isolated, which could form part of equipment with very different ground references.



It is good practice to ground the shield of the cable used only at one end (preferentially from the computer side) to avoid that potential differences between the two devices create a current circulation on the wiring screen, thus introducing communication disturbances; in some applications it is however possible to connect to both ends. The non-connection of the screen to the ground instead (disconnected from both ends) nullifies the function of the screen itself.

### 7.4.3 Profibus DP port wiring

Like the RS485 port, up to 32 devices (including the master) can be connected to a single line via the Profibus DP port, offering good noise immunity and a maximum transmission speed.

According to the specifications of the Profibus standard, the maximum length of the section is 1200mt at a maximum transmission rate of 93.75Kbps. It should be noted that the length of the section is inversely proportional to the communication speed and that at the maximum transmission speed of the gate, or 12 Mbps, the length of the section is 100 meters.

Through appropriate repeater devices (maximum 9) it is possible to extend the connection and connect up to 126 devices.

	<p>For correct operation it is necessary to use a suitable cable, terminating it appropriately. The termination consists in connecting at the beginning and at the end of the section of resistors with a defined ohmic value (see figure below); for the beginning and end of the section, the master and the most remote slave are considered respectively (called 1 and 4 in the figure below). The length of the cable connecting the intermediate line (called 2 and 3 in the figure below) must be as short as possible (in any case below 1mt), otherwise the signal quality will be lost.</p>
---	---

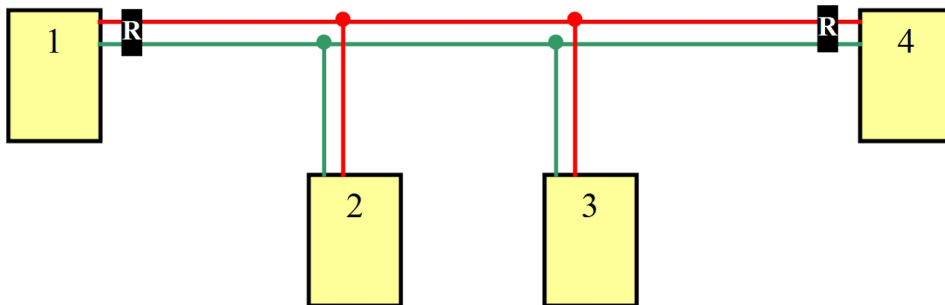

Example of Profibus wiring

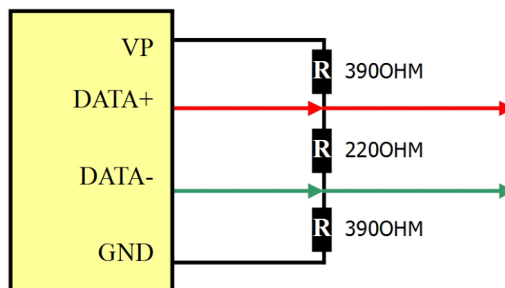

Termination resistors configuration

	<p>It is good practice to connect the shield of the cable used at both ends to the ground; the failure to connect the screen to the ground (disconnected from both ends) nullifies the function of the screen itself.</p>
---	---

### 7.4.4 Serial signals RS485, Profibus DP

The following figures show the waveforms detected by means of an oscilloscope in different connection situations.

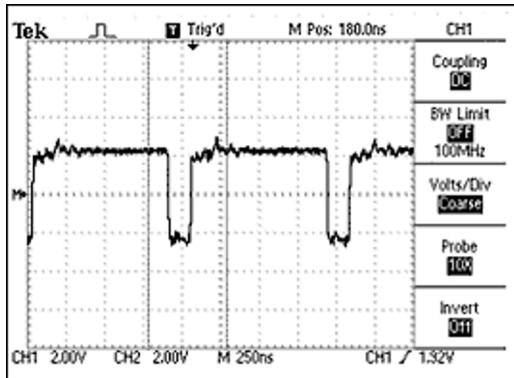

Example of a correct signal

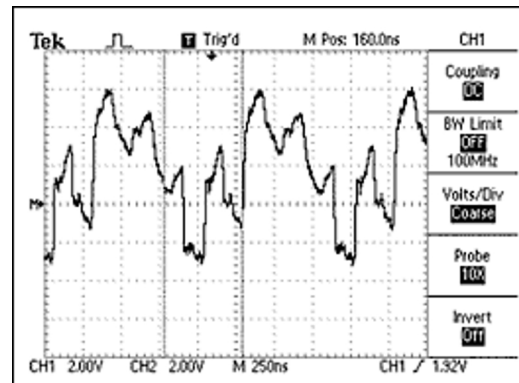

Example of a signal with unfinished lines

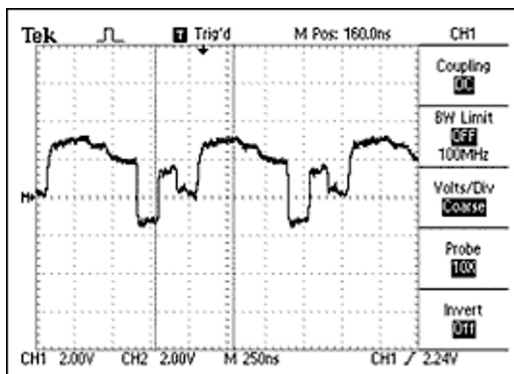

Example of a signal with placed terminations on the wrong device

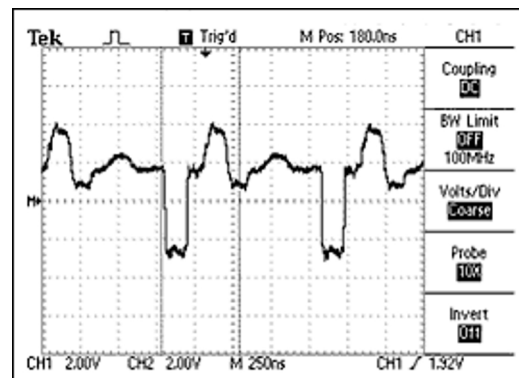

Example of a signal with incorrect value terminations

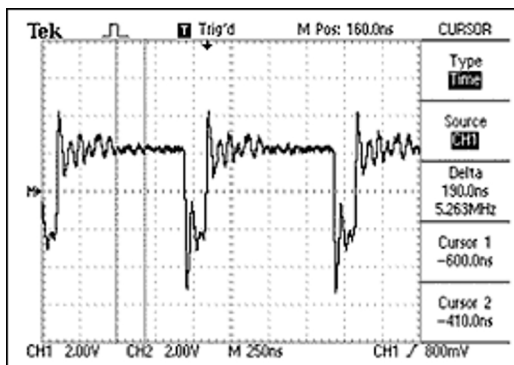

Example of signal on intermediate devices with long connections

## 8 Use

### 8.1 Touch screen

The use of the POSYC computer is very similar to a normal desktop computer; the only substantial difference is the touch screen pointing device which, however, allows an even more intuitive use of the computer.

#### **CAUTION**



Operate the touch screen sensor only with your fingers or soft and not sharp objects, otherwise you will damage it.

#### **ATTENTION**



Utilisez le capteur d'écran tactile uniquement avec vos doigts ou des objets mous et non tranchants, sinon vous risqueriez de l'endommager.

To operate the touch screen, a slight pressure is sufficient (this has the appearance of any glass plate) to command the operating system pointer to move below the area where the pressure has been exerted. Depending on the software settings, the touch screen simulates dragging, clicking, double clicking and right mouse button. Refer to the software manual for further details.

### 8.2 Front USB ports

The front USB ports have been designed to connect temporary devices such as keyboards and flash disks; the seat of the USB connectors ensures the IP65 degree of protection towards the inside of the computer both in use and in rest conditions.

#### **CAUTION**



To avoid oxidation damage to the contacts of the front USB connectors, once the use is finished protect them again with the special cap to protect them from dust and dirt. The cap does not guarantee IP65 protection to the USB connectors.

**ATTENTION**

	<p>Pour éviter que les contacts des connecteurs USB situés à l'avant ne soient endommagés par l'oxydation, une fois l'utilisation terminée, protégez-les à nouveau avec le capuchon spécial pour les protéger de la poussière et de la saleté. Le capot ne garantit pas la protection IP65 des connecteurs USB.</p>
---	---

**8.3 CFast card**

The POSYC CFast card replace the traditional hard disk giving it more robustness to shocks and increasing its useful life even in the presence of continuous work cycles.

The positioning of the flash card and the simplicity of extraction/insertion allows a quick replacement both in case of failure and off-line software update.

The operating system (Windows 10IOT Enterprise Entry) and an empty NTFS partition created to contain any future specific software or data are stored on the supplied flash card.

**CAUTION**

	<p>To avoid computer failure and/or data loss to the CFast card, the replacement of the same must be done exclusively at POSYC turned off.</p>
---	--

**ATTENTION**

	<p>Pour éviter toute panne d'ordinateur et / ou toute perte de données sur la carte CFast, son remplacement doit être effectué exclusivement à POSYC off.</p>
---	---



## 8.4 Boot devices priority

The boot device refers to the mass memories on which the operating system is stored (for example Windows, Linux, etc.) as CFast card and USB flash disk.

By default, POSYC searches for the operating system boot information in the mass memory used for the previous boot, such as CFast, and if it is found, the boot device is not changed; in contrast, another is sought on other ports, such as USB.

This is a behavior that depends on the working method of the UEFI BIOS.

In normal working conditions it is not necessary, and also not recommended for safety reasons, to start the POSYC from devices other than the supplied CFast.

For exceptional needs like backup, restore, BIOS update, etc. it is possible to start POSYC via USB flash disk (non UEFI) without having to access the CMOS setup parameters that are password protected for security reasons.

To start POSYC via USB flash disk for activities that do not need to access the CFast (for example BIOS update), to POSYC off extract the CFast from its housing, insert the USB flash disk containing the operating system, turn on the POSYC and run the necessary activities; at the end, turn off the POSYC, remove the USB flash disk and switch on the POSYC without CFast: an UEFI shell will be started. Switch off the POSYC again and insert the CFast in its housing; when it is switched on, POSYC will start from CFast.

To start POSYC via USB flash disk for activities that need access to the CFast (for example backup or restore), to POSYC off extract the CFast from its housing, insert the USB flash disk containing the operating system, turn on the POSYC and let it start from the USB flash drive. Turn off the POSYC, insert the CFast in its housing, turn on the POSYC and perform the necessary activities; at the end, turn off the POSYC, take out the USB flash disk and the CFast from its housing. Restart the POSYC: an UEFI shell will be started. Switch off the POSYC again and insert the CFast in its housing; when it is switched on, POSYC will start from CFast.

In some special situations, the Windows 10 IOT operating system may not be able to regularly restart with the default settings of the Cmos-Setup and therefore it is necessary to modify them by accessing them using the STECH password and setting, in the **Boot** page, the **New Boot Option Policy** item in **Place First** instead of **Default** and also set under **Boot Option # 1: Windows Boot Manager (P0: CFast 3ME4)**. Then save the modified parameters as follows:

- **Save & Exit**
- **Save Changes and Reset**
- The **"Save configuration and reset?"** window opens automatically
- Confirm with the keyboard **"Yes"**

Be careful not to change any other parameter, otherwise the device will not work.

## 9 Ordinary maintenance

### 9.1 Cleaning the touch screen sensor

The cleaning of the touch-screen sensor must take place rather frequently to avoid the stratification of the dirt derived from the hands or from materials that were accidentally in contact with its surface and to maintain the best possible visibility of the display.

If necessary, the front of the device (keyboard and viewing window) can be cleaned with a very soft cleaning cloth (recommended in microfibre) dampened with water or cleaning solution for display.

### 9.2 Replacing the clock battery

The replacement of the internal clock battery, in addition to ensuring the maintenance of the same, is useful not to lose the settings of the CMOS Setup (basic information for the operation of the computer).

Depending on the climate and how the computer is used, this can have a very variable duration starting from the POSYC production date.

It is therefore suggested to carry out the preventive battery replacement at least every 2 years taking care to always use the exact model (3V lithium battery - CR2032).

To replace it, simply remove the back cover of the computer with the power switched off and replace the battery (shown in the figure) with a new one. If the existing battery is not completely discharged, performing the replacement operation in a few seconds, it will not be necessary to correct date / time and settings of the CMOS Setup.

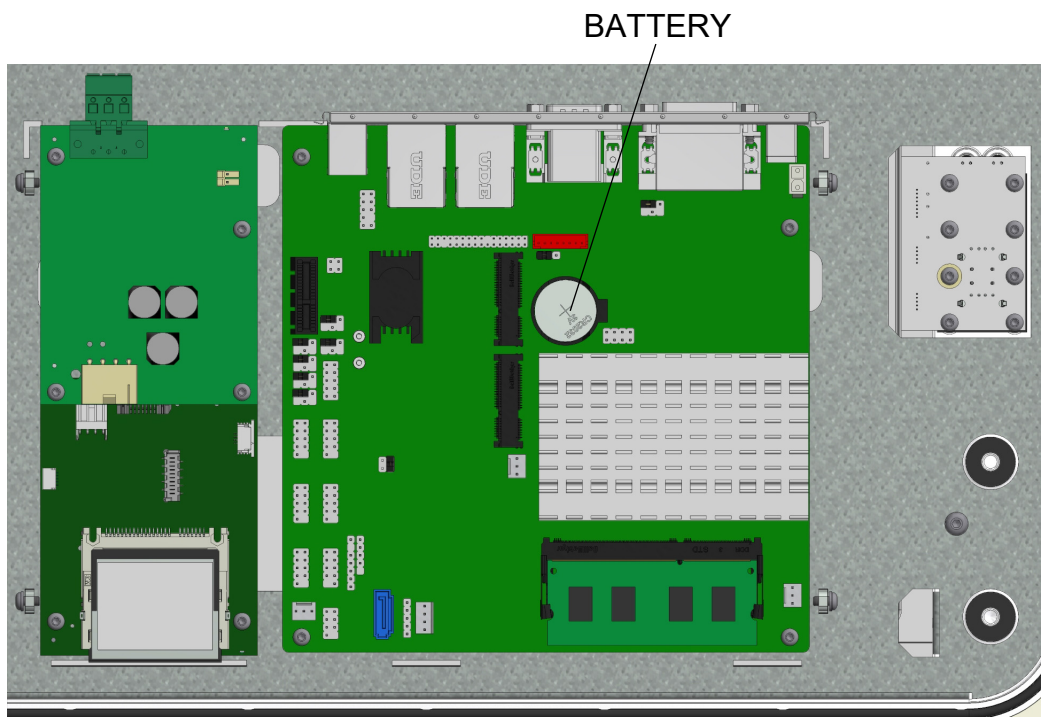

Battery position

### 9.3 CFast replacement

If it is necessary to replace the 32GB CFast flash disk (KE050070), the BIOS automatically changes its Boot settings. To allow the POSYC to be properly set up with the operating system installed on the new CFast, or Windows 10, it is necessary to modify the BIOS/CMOS parameters as described below:

- **Boot**
- **Boot Option Priorities**
- **Boot Option #1**
- **P0: CFast 3ME4** replace with **Windows Boot Manager (P0: CFast 3ME4)**

Performing the change described above, automatically in **Boot Option #2** the parameter changes as follows:

- **Windows Boot Manager (P0: CFast 3ME4)** is replaced with **P0: CFast 3ME4**

Then save the modified parameters in this way:

- **Save & Exit**
- **Save Changes and Reset**
- The "**Save configuration and reset ?**" window opens automatically
- Confirm with the "**Yes**" keyboard

## 10 Appendices

### 10.1 Appendix I: Parameters of the CMOS Setup

In the POSYC 430X series industrial PCs, the CMOS Setup parameters are stored in the BIOS to guarantee operation.

In the event that there is a loss of memory of the CMOS Setup, for example, after the backup battery has been used up, these will automatically reset when the POSYC starts up except for the date and time which can be reset using the operating system.

If the parameters are to be changed incorrectly, they can be reset using the "Load UEFI Defaults" function in the "Exit" menu of the CMOS Setup.

### 10.2 Appendix II: OS update and/or software installation

For security reasons and to maintain system integrity, the "Windows Module Installer" service is disabled; therefore, if it is necessary to perform operating system updates and/or system software installation, it is recommended to re-enable it only temporarily.

## 11 Analytical index

<b>A</b>	
Absorbed power .....	10
Audio .....	14
<b>B</b>	
Battery .....	16, 34
BIOS .....	33
Boot devices .....	33
<b>C</b>	
CFast card .....	8, 14, 23, 32
CMOS .....	33, 34, 36
Codes .....	15
COM1 .....	14, 17
COM2 .....	14, 17
CR2032 .....	34
Current consumption .....	10
<b>D</b>	
Display .....	8, 14
DVI-D .....	8, 17
<b>E</b>	
Ethernet .....	8, 14, 17, 22
<b>F</b>	
Fixing .....	11
<b>H</b>	
HDD .....	18
HDMI .....	8, 17
HMI .....	8
<b>I</b>	
Installation .....	24
IP65 .....	8
<b>M</b>	
Maximum altitude .....	10
Memory .....	8, 14
Monitor .....	14
<b>P</b>	
Panel mounting .....	24
Processor .....	8, 14
Profibus .....	18, 22
Protection degree .....	10
<b>R</b>	
Reset button .....	18
RJ45 .....	17
<b>T</b>	
Touch screen .....	14, 31
<b>U</b>	
UEFI .....	33
USB .....	8, 14, 17, 31
User .....	4
<b>V</b>	
Video .....	14
<b>W</b>	
Weight .....	11
Windows 10IOT .....	32