

Smitec S.p.A., via Carlo Ceresa 10, 24015 San Giovanni Bianco (BG), Italy, www.smitec.it



Installation, use and maintenance manual



BEFORE STARTING UP THE POSYC 5.0 SERIES INDUSTRIAL PCS, CAREFULLY READ THIS MANUAL AND FOLLOW ALL INSTRUCTIONS, IN ORDER TO ENSURE MAXIMUM SAFETY

INDUSTRIAL COMPUTERS

POSYC 5.0



The technical data and the drawings in this manual might have been modified later; always refer to the latest version.

Summary

1 Preface	4
2 General warnings	5
3 Safety instructions	7
3.1 General information	7
3.2 Precautions during handling and assembly	7
4 Product description	8
4.1 Code KZ010640/KZ010641/KZ010682/KZ010728; model T301/T302/T304/T305	8
4.2 Code KZ010647/KZ010648/KZ010714; model T401/T402/T403	9
4.3 Front and rear view 10.1" model	10
4.4 Front and rear view 18.5" model	11
5 Technical data	12
5.1 Environmental specifications	12
5.2 Electrical characteristics	12
5.2.1 Code KZ010640/KZ010641/KZ010682/KZ010728; model T301/T302/T304/T305	12
5.2.2 Code KZ010647/KZ010648/KZ010714; model T401/T402/T403	13
5.3 Mechanical characteristics	13
5.3.1 Fixing	13
5.3.2 Weight	13
5.3.3 Mechanical dimensions with 10.1" display	14
5.3.3.1 Front view	14
5.3.3.2 Side view	15
5.3.3.3 Rear view	15
5.3.4 Mechanical dimensions with 18.5" display	16
5.3.4.1 Front view	16
5.3.4.2 Side view	16
5.3.4.3 Rear view	17
5.4 Hardware features	18
5.4.1 Basic hardware common to T301/T302 models	18
5.4.2 Models T304/T305 hardware	18
5.4.3 Basic hardware common to T401/T402 models	19
5.4.4 Model T403 hardware	19
5.5 Order code	20
5.6 Accessories	21
6 Connections	22
6.1 Bottom view	22
6.1.1 Models T301/T302/T304/T305	22
6.1.1.1 Using SW1 button	23
6.1.2 Models T401/T402/T403	24
6.1.2.1 Using SW1 button	25
6.2 Rear view	26
6.2.1 Models T301/T302/T304/T305	26
6.2.2 Models T401/T402/T403	27
6.2.2.1 24Vdc connector	28
6.2.2.2 RS422/485 serial ports	29
6.2.2.2.1 Models T301/T302/T304/T305	29
6.2.2.2.2 Models T401/T402/T403	30
6.2.2.3 Ethernet ports	30
6.2.2.3.1 T301/T302/T304/T305 models	30
6.2.2.3.2 T401/T402/T403 models	30
6.3 Front view	31
6.3.1 24Vdc indicator LED behavior	31
7 Installation	32
7.1 Arm mounting	33

7.2 Electrical connections	35
7.2.1 RS485 serial ports wiring	35
7.2.2 RS422 serial port wiring	37
7.2.3 Serial signals RS485 and RS422 ports	38
8 Use	39
8.1 Capacitive touch screen	39
8.2 USB ports	39
8.3 Flash disk	40
8.3.1 CFast card for T301/T302/T304/T305	40
8.3.2 Micro SD card for T401/T402/T403	40
8.4 Boot device priority	40
9 Ordinary maintenance	42
9.1 Cleaning the touch screen sensor	42
9.2 Replacing the watch battery	42
10 Appendices	44
10.1 Appendix I: CMOS Setup Parameters	44
10.2 Appendix II: OS update and/or software installation	44
11 Analytical index	45

1 Preface

This manual provides all necessary information for the installation, use and maintenance of POSYC 5.0 series industrial PCs.

The instructions included in this manual are addressed to the following professionals:

User	User is a person, a company or an institution that buys the equipment and uses it for the purposes it was designed for.
User/operator	User or operator is a person authorized by the user to operate on the equipment.
Specialized personnel	It refers to all persons with specific competence, able to recognize and avoid the dangers deriving from the use of the equipment.

The present instructions must be made available to all the above individuals.





2 General warnings

These assembly instructions are an integral part of the equipment, and must be kept for future reference until decommissioning.

The user should be informed that the present instructions reflect the state of the art at the moment when the equipment was sold; they will remain fully acceptable despite subsequent upgrades based on new experiences.

	<p>DO NOT USE THE EQUIPMENT, NOR MAKE ANY INTERVENTION BEFORE INTEGRALLY READING AND UNDERSTANDING THIS MANUAL.</p>
<p>IN PARTICULAR, ADOPT ALL SAFETY PRECAUTIONS AND PRESCRIPTIONS INDICATED IN THIS MANUAL.</p>	
<p>THE EQUIPMENT CANNOT BE USED FOR PURPOSES DIFFERENT THAN THE ONES DESCRIBED IN THIS MANUAL; SMITEC S.p.A. SHALL NOT BE HELD RESPONSIBLE FOR ANY DAMAGES, INCONVENIENCES OR ACCIDENTS DUE TO THE NON-COMPLIANCE WITH THESE PRESCRIPTIONS.</p>	

In order to make the manual consultation easier, the following symbols have been adopted:



	<p>Indication of "PROHIBITED ACTION".</p>
	<p>The symbol "DANGER" is used when the non-respect of the prescriptions or the tampering of organs can cause serious harm to people or things.</p>
	<p>The symbol "USE OF INDIVIDUAL PROTECTIONS" means that protective gloves must be worn.</p>
	<p>Indication of "INFORMATION OF PARTICULAR RELEVANCE".</p>

The safety prescriptions aim at establishing a series of behaviors and obligations to be complied with, while performing the activities described later on in this manual.



These prescriptions constitute the prescribed method of operating the device, in a way that is safe for personnel, equipments and environment.

3 Safety instructions

3.1 General information

	<p>Do not install or use the equipment before integrally reading and understanding this manual. In case of difficulties of interpretation, contact SMITEC technical service.</p> <p>It is absolutely forbidden to use the equipment for different purposes than the ones described in this manual. The technical data and the drawings in this manual might have been modified later; always refer to the latest version. All upgrades can be requested to SMITEC S.p.A. directly.</p>
	<p>Make sure that the personnel is qualified and adequately informed about the risks he may run and how to avoid them.</p>
	<p>POSYC 5.0 series industrial PCs can be used only after the classification of the machine operating area and after checking the safety levels, which must correspond to the assembly safety levels.</p>

3.2 Precautions during handling and assembly

	<p>Use adequate tools during the assembly, in order to avoid crushing or abrasions.</p>
	<p>Metal components and sharp surfaces may cause cuts and tears. In case of contact, be very careful and wear the personal protection equipment.</p>

4 Product description

The POSYC 5.0 series is divided into 2 families with different electrical characteristics:

4.1 Code KZ010640/KZ010641/KZ010682/KZ010728; model T301/T302/T304/T305

The POSYC model T301/T302/T304/T305 is a personal computer based on Intel®64 architecture designed mainly to facilitate human-machine interfacing (HMI) in an industrial environment, but its characteristics also make it suitable for different uses, such as information and automation systems in general.

The user interface mainly uses a flat colour display and a capacitive touch screen pointing system integrated into the product.

The 1024x600px 16M colour LED-illuminated TFT liquid crystal flat display with a diagonal size of 10.1" for the T301/T305 model and the 1366x768px display with a diagonal of 18.5" for the T302/T304 models, offers in both cases great brightness, brilliance of the colours and good viewing angle.

The multi-touch capacitive touch screen system offers characteristics of robustness and ease of use, which are difficult to obtain with other common pointing devices such as mice, track-balls and mouse pads.

Being completely integrated into the device, it is also particularly suitable in industrial applications that require resistance to external agents such as dust, humidity, water, oils, which would be harmful to standard peripherals.

Since it is sufficient to exert slight pressure with a finger on its surface to perform immediate pointing, this system is the main "User Friendly" feature of the POSYC computer.

To meet the most diverse interfacing needs, POSYC also provides the possibility of connecting standard input/output peripherals, such as keyboard, mouse, track-ball, etc.

In its minimum configuration, the POSYC can communicate with the outside world via 2 isolated RS422/485 serial ports; it also offers 1 standard USB 2.0 port and 1 standard 3.0 port and 2 Ethernet ports with 1Gb communication speed.

The computing capacity for the T301/T302 models is given by the Intel® Atom™ x5-E3940 processor, quad-core 1.6/1.8GHz with 4GB DDR3L SDRAM 1866 MT/s memory, while for the T304/T305 model it is given by the Intel processor @ Atom™ X6413E, quad-core 1.5/3.0GHz with 8GB LPDDR4x SDRAM 4267MT/s memory.

The storage of data and programs on non-volatile support is entrusted to a 64GB CFast card (high-speed flash-type solid-state memory) with S.O. W10IOT preloaded. The position of the device inside the POSYC is such as to allow its extraction without opening it. The main advantage of the CFast card is its exceptional resistance to accidental shocks and vibrations.

The new design makes it particularly attractive even for non-industrial applications.

4.2 Code KZ010647/KZ010648/KZ010714; model T401/T402/T403

The POSYC model T401/T402 is a personal computer based on ARM® architecture, also designed mainly as for the models described in paragraph 4.1, to facilitate human-machine interfacing (HMI) in an industrial environment, even if its characteristics they also make it suitable for different uses, such as information terminals and automation systems in general.

The user interface mainly uses a flat colour display and a capacitive touch screen pointing system integrated into the product with a 1024x600px display for the 10.1" T401 model and a 1366x768px display for the 18.5" diagonal T402 model.

In its minimum configuration, the POSYC can communicate with the outside world via 3 non-isolated RS485 serial ports; it also offers 2 standard USB 2.0 ports and 1 Ethernet port with 10/100 Mb communication speed. For the T401/T402 models, the POSYC computing power is provided by the ARM® CORTEX-A9 processor, single-core, 1.0GHz in addition to CORTEX-M4, single-core, 227MHz with 1GB DDR3L SDRAM memory; while the T403 model has an ARM® CORTEX-A53 processor, quad core, 1.6GHz in addition to CORTEX-M4, single-core, 400MHz with 2GB LPDDR4 DRAM memory.

The storage of data and programs on non-volatile support is entrusted to a 4GB micro SD with S.O. Linux preloaded. The position of the device inside the POSYC is such as to allow its extraction without opening it.

The new design makes it particularly attractive even for non-industrial applications.

4.3 Front and rear view 10.1" model

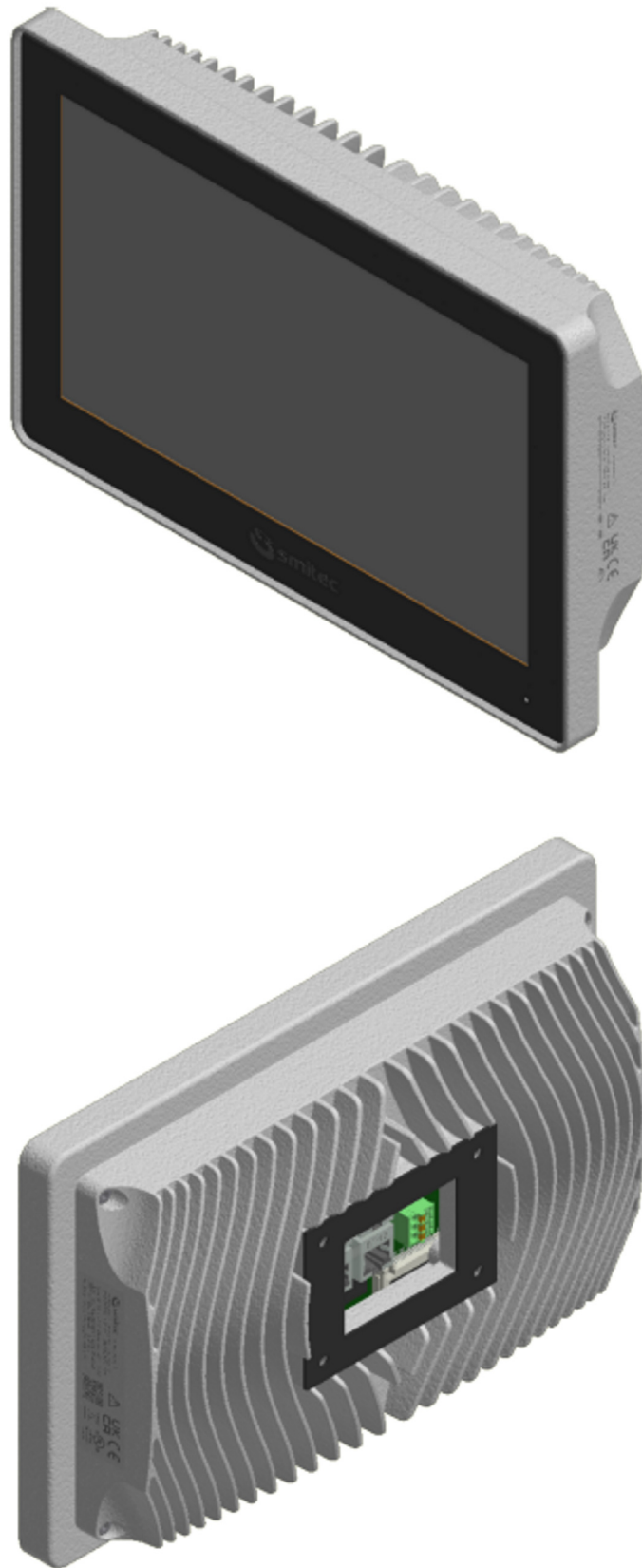

4.4 Front and rear view 18.5" model

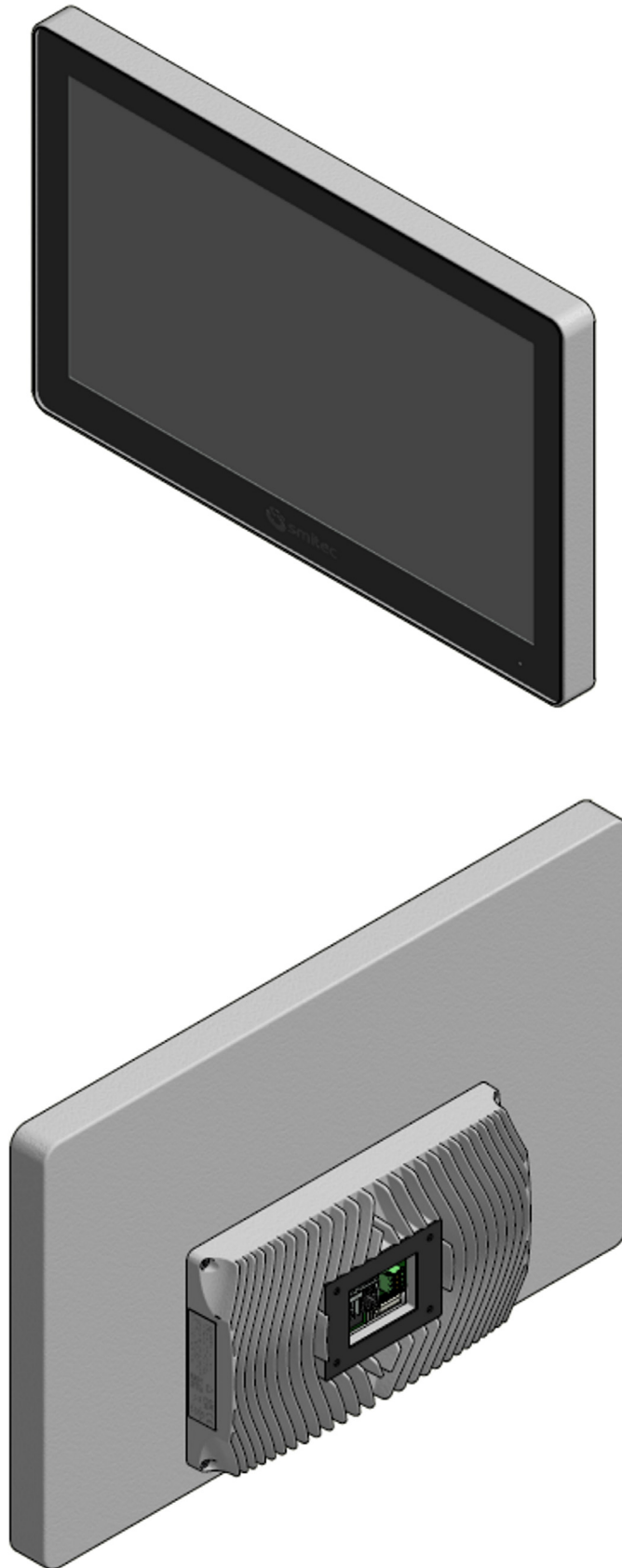

5 Technical data

	<p>All the technical information reported in this section are consistent with the hardware configuration of the POSYC computer produced at the date of writing of this document. With the aim of improving or updating the product technologically, SMITEC S.p.A. reserves the right to change the technical features of the POSYC computer without notice.</p>
---	---

5.1 Environmental specifications

Operating temperature	0° ÷ 45°C: mounted on mechanical arm (for T301/T302/T304/T305 models)
	0° ÷ 50°C: mounted on mechanical arm (for T401/T402/T403 models)
Storage temperature	-20° ÷ +60°C (when not operational)
Relative humidity	0 ÷ 90% (without condensation)
Protection degree	IP65 or "UL type 1" (installed as per instructions in chapter 7)
Maximum altitude	2000 m (above sea level)

5.2 Electrical characteristics

The following characteristics refer to the standard POSYC computer load as supplied, without any connected peripheral device.

5.2.1 Code KZ010640/KZ010641/KZ010682/KZ010728; model T301/T302/T304/T305

Main power supply voltage	24 VDC (-15% ÷ + 20% according to EN 61131-2) from a class 2 (UL) power supply
Current consumption	Cod. KZ010640: Max 1.00A @ 24VDC
	Cod. KZ010641: Max 1.30A @ 24VDC
	Cod. KZ010682: Max 1.70A @ 24VDC
	Cod. KZ010728: Max 1.40A @ 24VDC
Absorbed power	Cod. KZ010640: Max 24W
	Cod. KZ010641: Max 31W
	Cod. KZ010682: Max 41W
	Cod. KZ010728: Max 34W

5.2.2 Code KZ010647/KZ010648/KZ010714; model T401/T402/T403

Main power supply voltage	24 VDC (-15% ÷ + 20% according to EN 61131-2) from a class 2 (UL) power supply
Absorbed current	Code KZ010647/714: Max 1.00A @ 24VDC
	Code KZ010648: Max 1.30A @ 24VDC
Absorbed power	Code KZ010647/714: Max 24W
	Code KZ010648: Max 31W

5.3 Mechanical characteristics

5.3.1 Fixing

Typology	On the mechanical arm via 4 M4 threaded holes
-----------------	---

5.3.2 Weight

	With packaging	POSYC only
10.1" model	2,8 kg	2,6 kg
18.5" model	7,4 kg	6,8 kg

5.3.3 Mechanical dimensions with 10.1" display

5.3.3.1 Front view

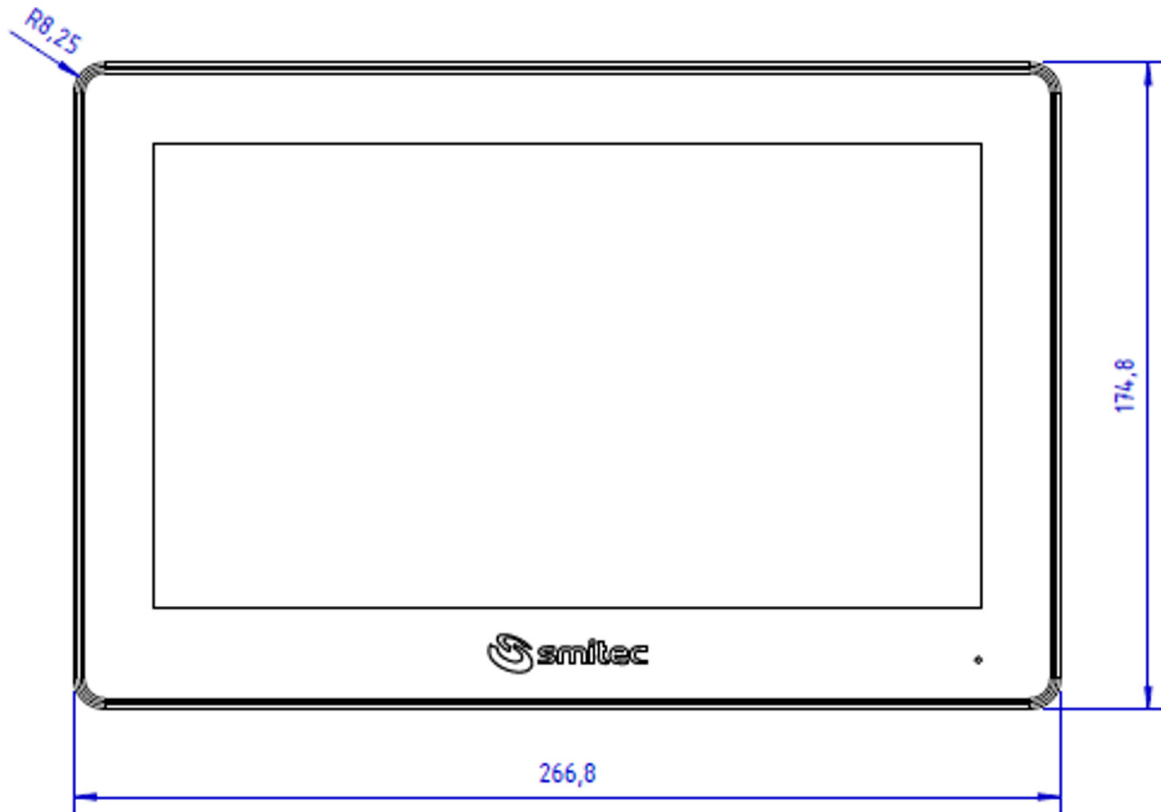

5.3.3.2 Side view



5.3.3.3 Rear view

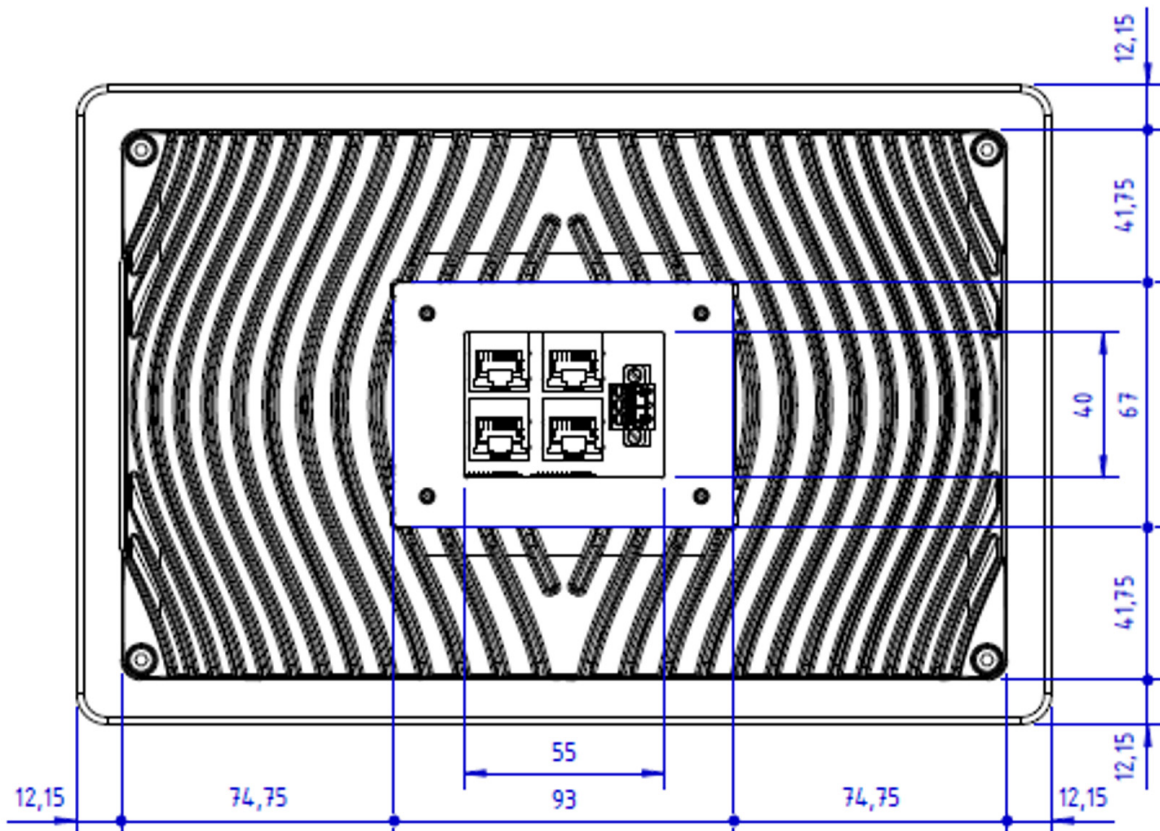

5.3.4 Mechanical dimensions with 18.5" display

5.3.4.1 Front view

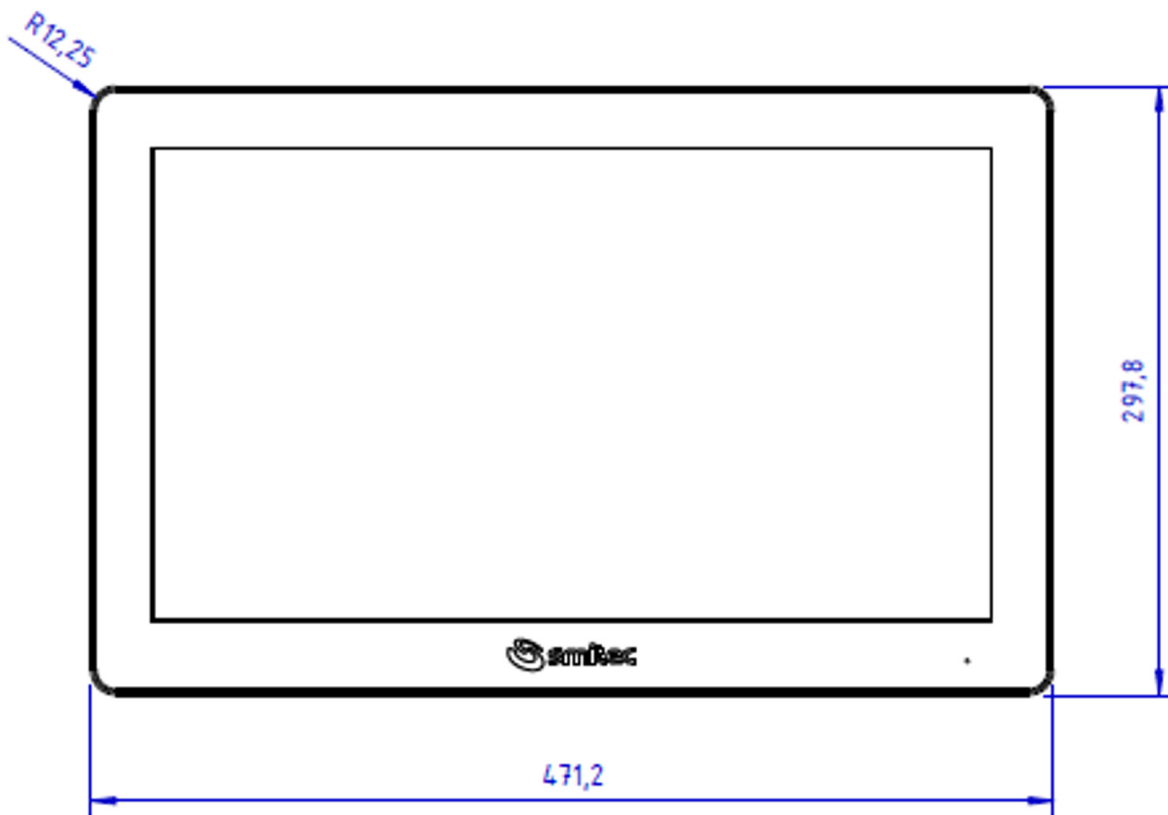

5.3.4.2 Side view



5.3.4.3 Rear view

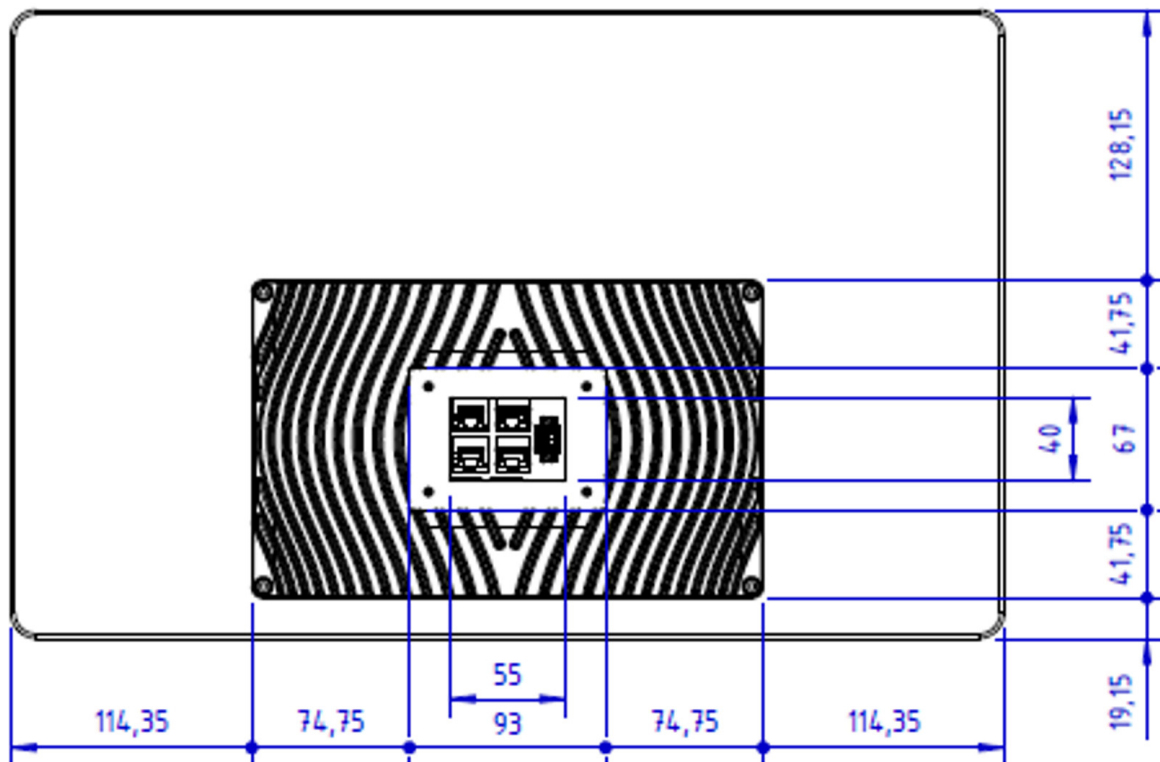

5.4 Hardware features

5.4.1 Basic hardware common to T301/T302 models

Processor	Intel® Atom x5-E3940, quad-core, 1.6/1.8GHz, 9.5W
Memory	4GB DDR3L SDRAM 1866 MT/s
CFast card	64GB - 430 MB/s reading, 290 MB/s writing
Touch screen sensor	Capacitive
COM1 serial port	RS422/485 isolated
COM2 serial port	RS422/485 isolated
USB ports	1 x 3.0
	1 x 2.0
Ethernet ports	2 x 1Gb

The only difference between the two models T301 and T302 concerns the different type of display mounted:

Display model T301	10.1" colour TFT LED, 1024x600, 16M colours
Display model T302	18.5" colour TFT LED, 1366x768, 16M colours

5.4.2 Models T304/T305 hardware

Processor	Intel® Atom™ X6413E, quad-core 1.5/3.0GHz, 9W
Memory	8GB LPDDR4x SDRAM 3733 MT/s
CFast card	64GB - 430 MB/s reading, 290 MB/s writing
Touch screen sensor	Capacitive
COM1 serial port	RS422/485 isolated
COM2 serial port	RS422/485 isolated
USB ports	1 x 3.0
	1 x 2.0
Ethernet ports	2 x 1Gb

The only difference between the two models T304 and T305 concerns the different type of display mounted:

Display model T304	18.5" colour TFT LED, 1366x768, 16M colours
Display model T305	10.1" colour TFT LED, 1024x600, 16M colours

5.4.3 Basic hardware common to T401/T402 models

Processor	ARM single core CORTEX-A9 @ 1GHz + CORTEX-M4 @ 227MHz
Memory	1GB DDR3L SDRAM 800MHz
Flash disk	Micro SD 4GB
Touch screen sensor	Capacitive
Serial port L0	RS422/485 not isolated
Serial port L1	RS422/485 not isolated
Serial port L2	RS422/485 not isolated
USB ports	2 x 2.0
Ethernet ports	1 x 10/100 Mb

The only difference between the two models T401 and T402 concerns the different type of display mounted:

Display model T401	10.1" a Color LED TFT,1024x600,16M colours
Display model T402	18.5" colour TFT LED, 1366x768, 16M colours

5.4.4 Model T403 hardware

Processor	ARM quad core CORTEX-A53 @ 1.6GHz + CORTEX-M4 @ 400MHz
Memory	2GB LPDDR4 DRAM
Flash disk	Micro SD 4GB
Touch screen sensor	Capacitive
Serial port L0	RS422/485 not isolated
Serial port L1	RS422/485 not isolated
Serial port L2	RS422/485 not isolated
USB ports	2 x 2.0
Ethernet ports	1 x 10/100 Mb
Display	10.1" a Color LED TFT,1024x600,16M colours

5.5 Order code

Order code	Model	Description
KZ010640	T301	POSYC series 5.0 E3940 10.1"
KZ010641	T302	POSYC series 5.0 E3940 18.5"
KZ010682	T304	POSYC series 5.0 X6413E 18.5"
KZ010647	T401	POSYC series 5.0 ARM 10.1"
KZ010648	T402	POSYC series 5.0 ARM 18.5"
KZ010714	T403	POSYC series 5.0 ARM 10.1"
KZ010728	T305	POSYC series 5.0 X6413E 10.1"

5.6 Accessories

POSYC 5.0 industrial computers are supplied with power connector, mass storage and W10 IOT Enterprise license. They can be ordered separately as well as other accessories not included in the POSYC.

Below is the list of order codes:

Order code	Item
KF101089	24VDC connector (Phoenix Contact 1335913) *
KE020045	Empty 64GB CFast card (only for T301, T302, T304 and T305)
KE050106	CFast system card and NTFS with o.s. W10IOT * (only for T301)
KE050107	CFast system card and NTFS with o.s. W10IOT * (only for T302)
KE050116	CFast system card and NTFS with o.s. W10IOT * (only for T304)
KE020040	Empty 4GB micro SD flash disk (only for T401 and T402)
KE050109	4GB micro SD flash disk with OS Linux* (only for T402)
KE050110	4GB micro SD flash disk with OS Linux* (only for T403)
KE050122	4GB micro SD flash disk with OS Linux* (only for T401)
KE050130	CFast system card and NTFS with o.s. W10IOT * (only for T305)
TB010554	3V CR2032 Lithium Button Battery*

* = Supplied with the POSYC

6 Connections

6.1 Bottom view

6.1.1 Models T301/T302/T304/T305

On the lower part of the T301/T302/T304/T305 models we find the USB ports and the removable slot door, under which the CFast card flash disk memory is housed. The memory is secured inside the computer via a door secured by two cross-head flat head screws:

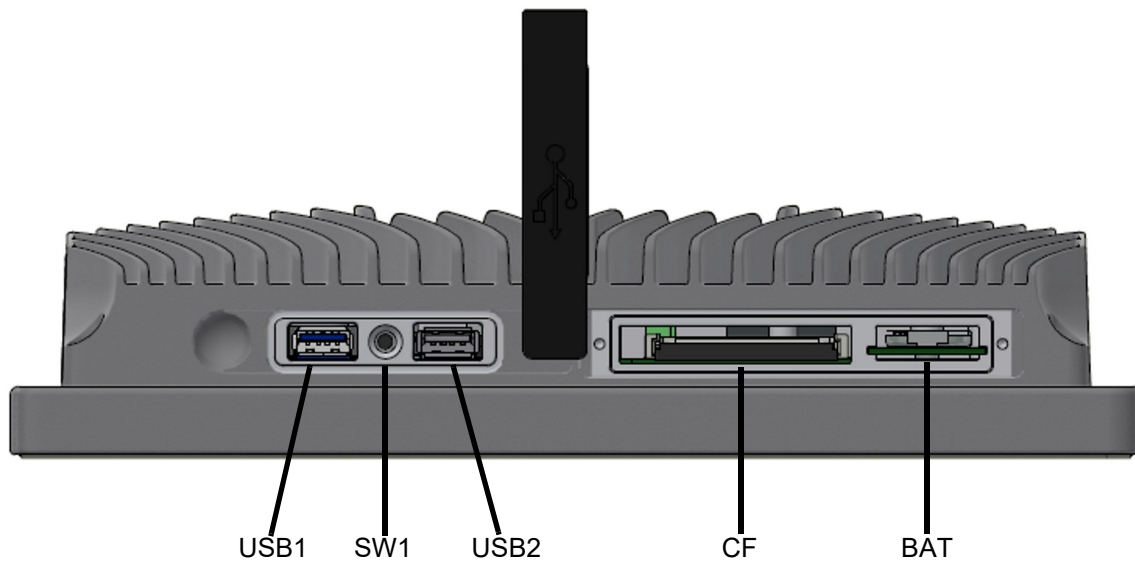

Name	Function
USB1	USB 3.0 port
USB2	USB 2.0 port
CF	CFast card installation memory with W10IOT operating system
SW1	Standby/reset button
BAT	CR2032 button battery

6.1.1.1 Using SW1 button

The SW1 button has been provided for cases in which the user needs to perform a shutdown of the operating system or, in the event of unexpected blocks or software malfunctions, needs to force a restart of the device. Depending on the time in which the SW1 button is pressed, different POSYC behaviors are obtained; below is an explanatory summary table:

Time of pressing the SW1 button	POSYC status
Short - Time of 1 s	Operating system shutdown and device standby; panel LED flashing (depending on operating system settings)
Prolonged - Time approximately 3-4 s	Forced reset (stopping and restarting the OS) and flashing of the panel LED (depending on the operating system settings)

It should be noted that in the first case described above, the LED continues to flash until the SW1 button is pressed again; once SW1 has been pressed for 1 s, the POSYC starts again loading the operating system.

6.1.2 Models T401/T402/T403

On the lower part of the T401/T402/T403 models we find the USB ports and the removable slot door, under which the 4GB micro SD flash disk is housed. The memory is secured inside the computer via a door secured by two cross-head flat head screws:

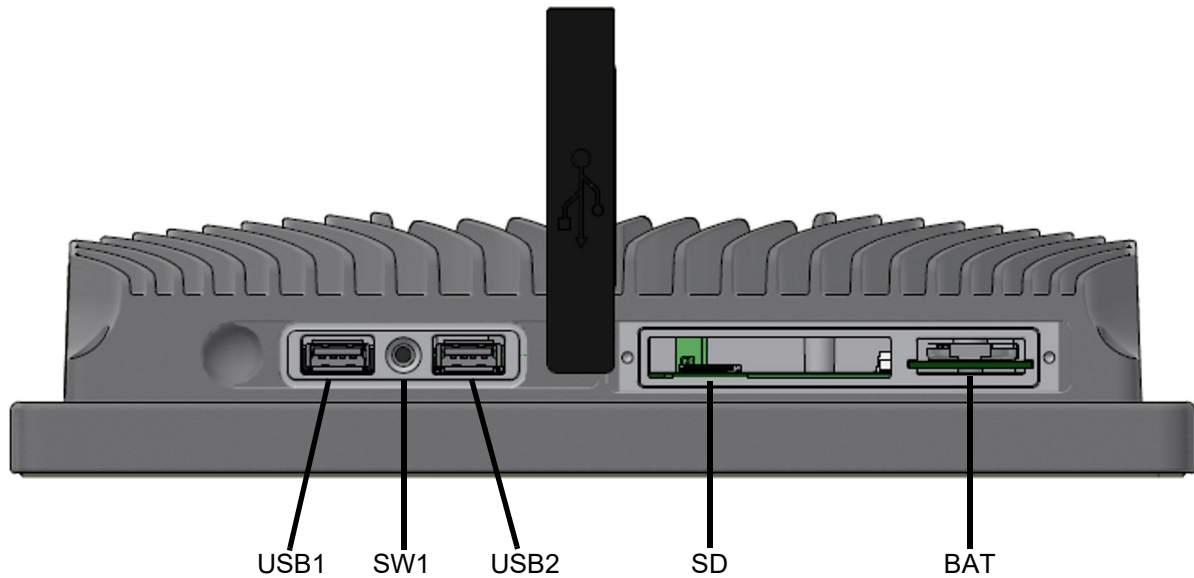

Name	Function
USB1	USB 2.0 port
USB2	USB 2.0 port
SD	Micro SD installation memory with Linux operating system
SW1	Standby/reset button
BAT	CR2032 button battery

6.1.2.1 Using SW1 button

The SW1 button has been provided for cases in which the user needs to perform a shutdown of the operating system.

Below is an explanatory summary table:

Time of pressing the SW1 button	POSYC status
Time of 1 s	Operating system shutdown and device standby; panel LED flashing (depending on operating system settings)

It should be noted that the LED continues to flash until the SW1 button is pressed again; once SW1 has been pressed for 1 s, the POSYC starts again loading the operating system.

6.2 Rear view

On the back of the POSYC, we find the connectors dedicated to the Ethernet and serial ports, different in number and characteristics based on the model and the power connector which is the same for all models in the family:

6.2.1 Models T301/T302/T304/T305

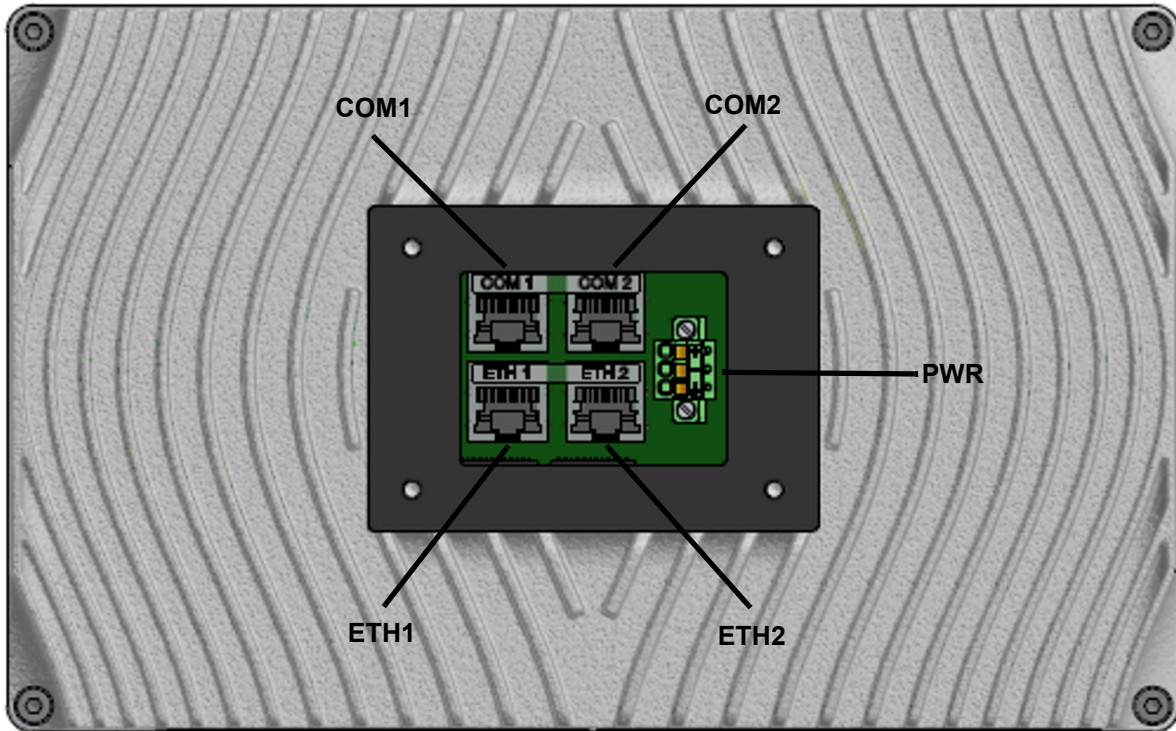

Name	Function
COM1	RS422/485 isolated serial port 1
COM2	RS422/485 isolated serial port 2
ETH1	1 Ethernet 1Gb port
ETH2	2 Ethernet 1Gb port
PWR	24Vdc power connector

6.2.2 Models T401/T402/T403

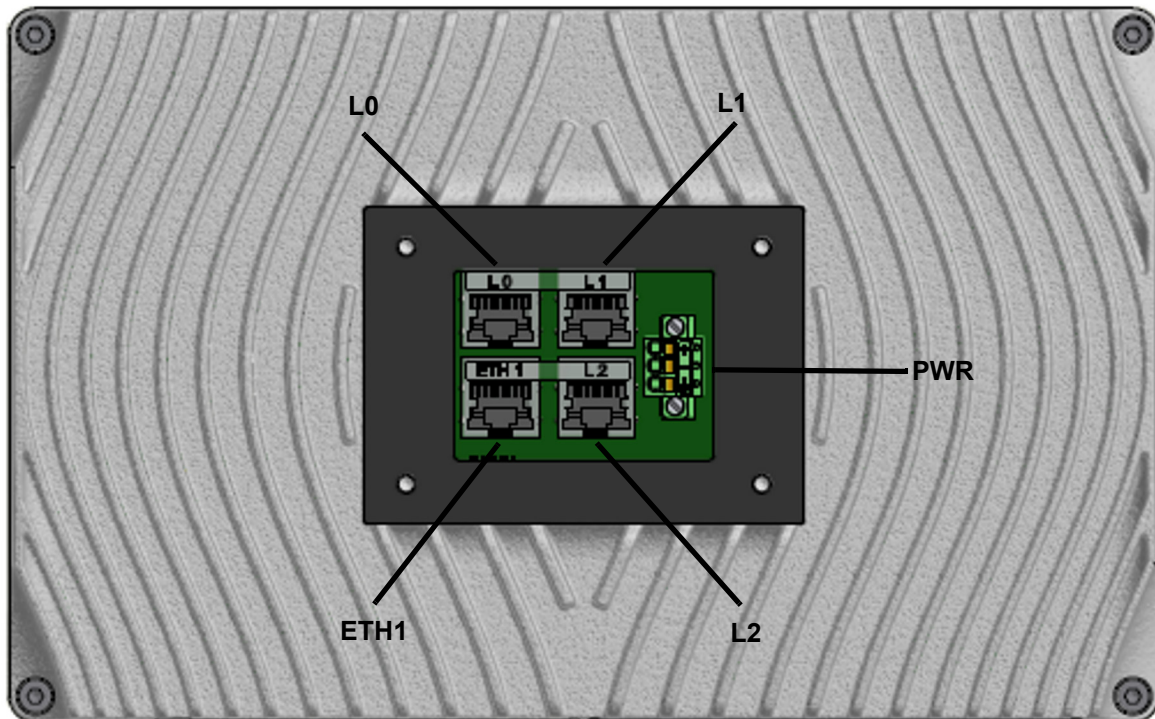

Name	Function
L0	RS422/485 isolated serial port 1
L1	RS422/485 isolated serial port 2
L2	RS422/485 isolated serial port 3
ETH1	1 Ethernet 10/100 Mb port
PWR	24Vdc power connector

6.2.2.1 24Vdc connector

Connector type: Phoenix Contact FK-MCP 1,5/ 3-STF-3,81 BDERDQMQ (1335913) * **				
Order code: KF101089				
Features		Conductors cross section		
Connection in accordance with	EN-VDE	Solid min.	0,14 mm ²	26 AWG
Rated voltage	160 V	Solid max.	1,5 mm ²	16 AWG
Rated current	8 A	Stranded min.	0,14 mm ²	26 AWG
		Stranded max.	1,5 mm ²	16 AWG
Insulating material	PA	Stranded, with ferrule without plastic sleeve min.	0,25 mm ²	26 AWG
Inflammability class according to UL 94	V0	Stranded, with ferrule without plastic sleeve max.	1,5 mm ²	16 AWG
Stripping length	9 mm	Stranded, with ferrule with plastic sleeve min.	0,25 mm ²	26 AWG
Screwdriver to be used for opening the connections	0,6x3,5 mm	Stranded, with ferrule with plastic sleeve max.	0,75 mm ²	16 AWG
*= Use only 75°C cables				
**= Use only copper conductors				

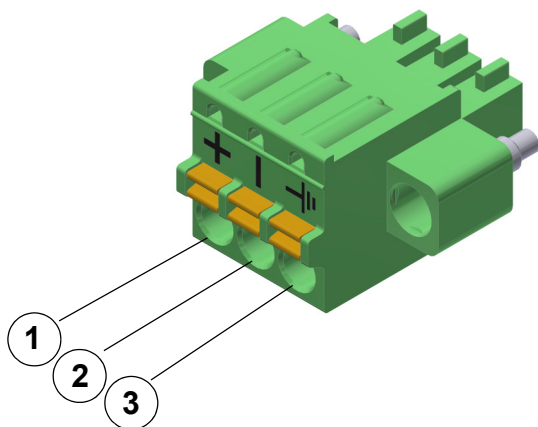

Supply 24Vdc	
Pin	Signal
1	+24 V
2	GND
3	FE (Functional Earth)

To tighten the 2 slotted head connector screws, use a screwdriver of the appropriate size; use a tightening torque of 0.3 Nm.

ATTENTION

	<p>Use a cable with a suitable cross-section, sized correctly according to the through-current. A cable with a section smaller than that required may cause fire due to overheating phenomena generated by the cable itself.</p>
	<p>To ensure compliance with the EMC 2014/30 / EU directive, the length of the cables must not exceed a length of 30 meters.</p>
	<p>The POSYC 5.0 is a high-tech electronic device, sensitive to electrostatic discharge (ESD) phenomena. Pay the utmost attention to prevent such phenomena, complying with the provisions of the law, in order to avoid damage to the device.</p>

6.2.2.2 RS422/485 serial ports

6.2.2.2.1 Models T301/T302/T304/T305

Below is the pinout of the RJ45 female connector belonging to the 2 serial ports COM1 and COM2 of the T301/302 models of isolated RS422/485 type; as depicted in the image below, the connector is made up of 8 pins:

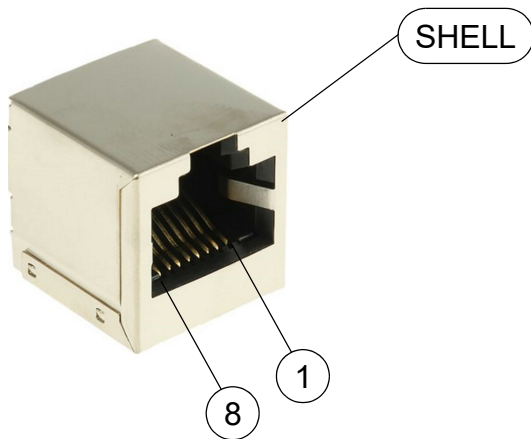

RS422/485 serial - COM1 and COM2	
Pin	Signal
1	DATA- (TD-) RS422/485
2	DATA+ (TD+) RS422/485
3	DATA+ (RD+) RS422
4	DATA- (RD-) RS422
5	GND
6	GND
7	ENABLE RS422
8	GND
SHELL	SCHERMO CAVO

By default the COM1 and COM2 ports are configured as RS485; to change this setting and configure the port as RS422, it will be necessary to short-circuit the signals of pins 7 and 8, i.e. ENABLE RS422 and GND.

6.2.2.2.2 Models T401/T402/T403

Below is the pinout of the RJ45 female connector belonging to the 3 serial ports COM1, COM2 and COM3 of the non-isolated RS485 type T401/402/403 models; as depicted in the image below, the connector is made up of 8 pins:

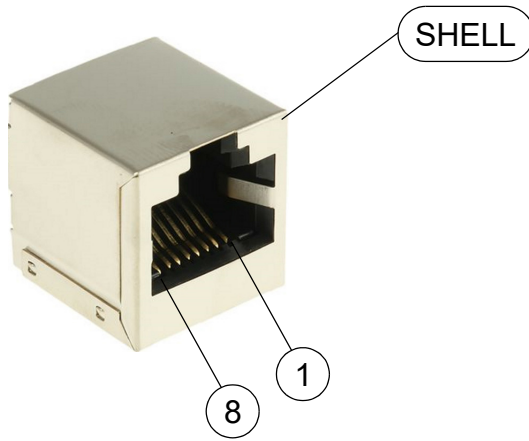

RS485 serial - COM1, COM2 and COM3	
Pin	Signal
1	DATA- (TD-) RS485
2	DATA+ (TD+) RS485
3	GND
4	NC
5	NC
6	NC
7	NC
8	NC
SHELL	SCHERMO CAVO

6.2.2.3 Ethernet ports

6.2.2.3.1 T301/T302/T304/T305 models

There are two 1Gbps Ethernet ports which use standard RJ45 Ethernet connectors.

6.2.2.3.2 T401/T402/T403 models

There is a 10/100 Mbps Ethernet port which uses standard RJ45 Ethernet connectors.

6.3 Front view

6.3.1 24Vdc indicator LED behavior

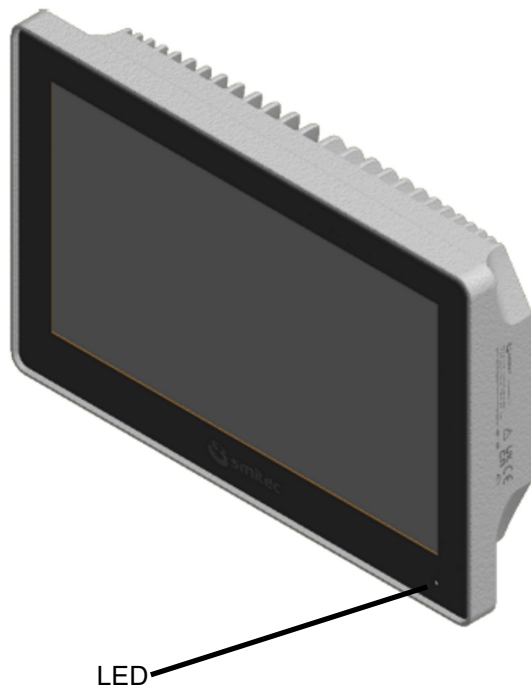

On the front of the POSYC, positioned at the bottom right of the panel, there is a white LED. It has the function of indicating in which operating state the device is found; Below is an explanatory summary table:

LED status	POSYC status
LED off (OFF)	24Vdc power supply absent; POSYC off
LED flashes (ON/OFF with a frequency of 1Hz)	24Vdc power supply present; POSYC on standby
LED on (ON)	24Vdc power supply present; POSYC powered up and operational



POSYC panel LED positioning

7 Installation

	<p>During installation of the POSYC 5.0 computer, falls and violent shocks must be avoided which could compromise the smooth operation.</p>
	<p>Avoid touching the input / output connectors on the computer panel directly unless you are equipped with suitable static electricity protection equipment; any discharges on the connectors could damage the appliance.</p>
	<p>Since the front panel integrates the touch screen sensor, violent blows in addition to damaging it irreparably could bring to light cut-glass shards, therefore dangerous for the operator.</p>
	<p>Always carry out all electrical connections when the equipment is switched off: this will prevent damage to the computer and danger to the operator (exceptions to connections to the USB ports are possible).</p>
	<p>Always make sure that all the devices connected to the POSYC have an efficient grounding (if foreseen by the device). Failure to follow this precaution could result in damage to the computer and danger to the operator.</p>
	<p>Do not position the device so that it is difficult to disconnect the wiring connected to it.</p>

7.1 Arm mounting

Mounting on the support arm must be done by firmly attaching a mating flange to the rear side of the POSYC. The rear side is provided with a planar support area complete with a gasket to seal the joint against liquids and dust; the dimensions of the area and the type of screws to be used are the same for both display sizes of the POSYC.

The arm and the relative fixings to the machinery must be appropriately sized to support the arm itself, the weight of the POSYC and an overload due to any support by the machinery operator.

For visual comfort and pointing accuracy on the touch screen, the support system must be sufficiently rigid so as not to wobble during normal use of the touch screen.

To maintain the POSYC's level of protection against liquids and dust, the support system must be appropriately protected through the use of gaskets, labyrinths, etc. Any damage to the POSYC due to failure to comply with these precautions will immediately void the warranty.

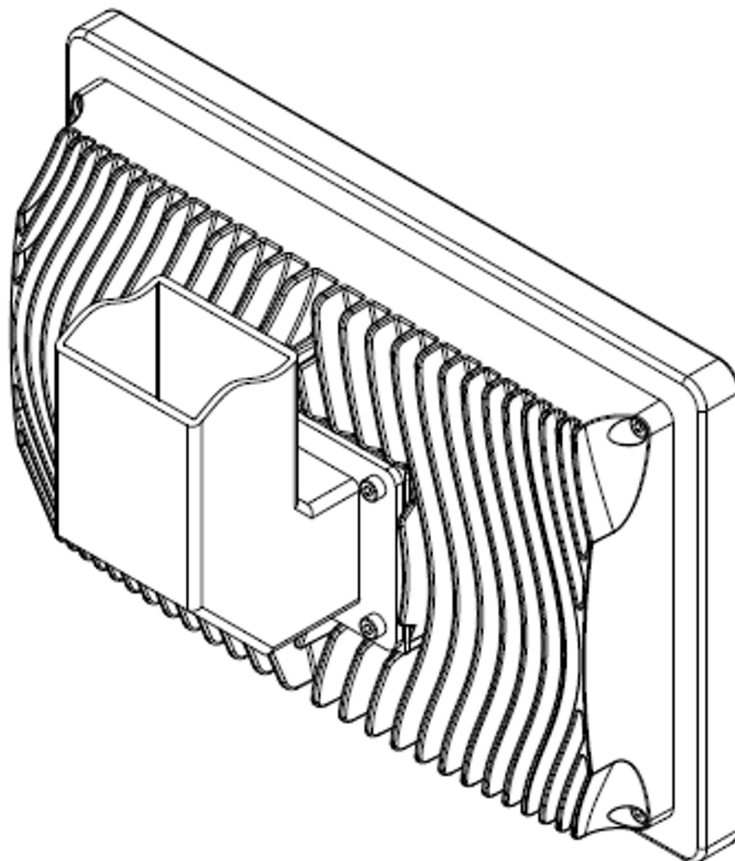

Example of support arm

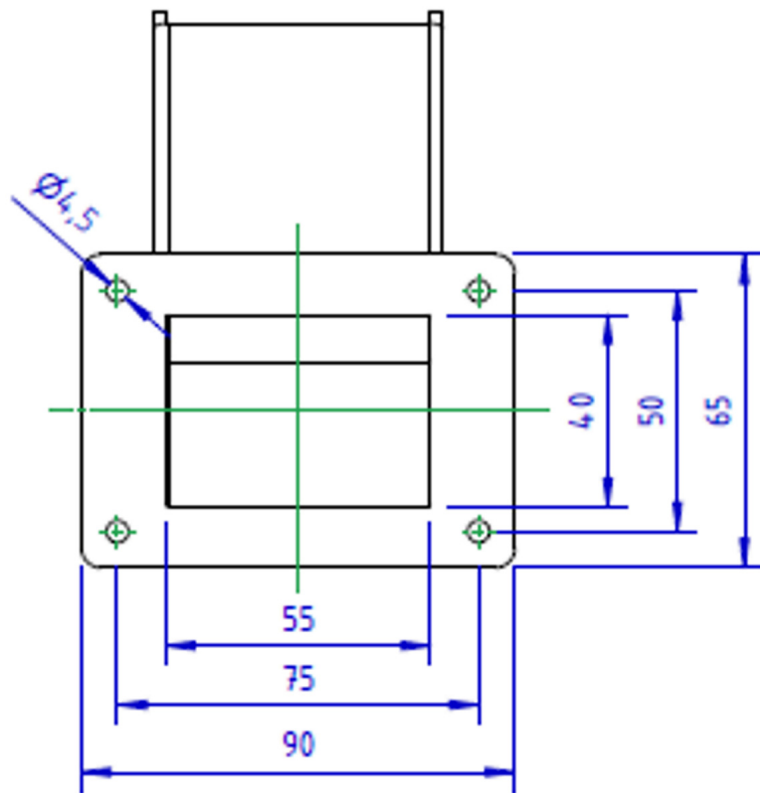

Recommended dimensions for flange

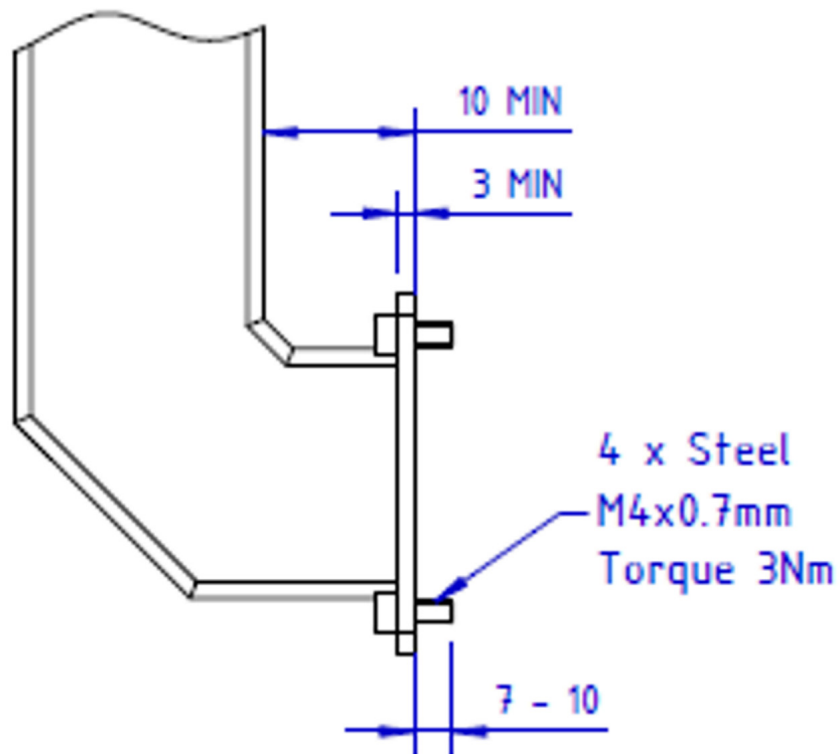

Recommended measurements for fixing to the arm

7.2 Electrical connections

The essential connections for POSYC operation are power and ground; make these two connections by following the polarity, conductors and connectors indicated in the “Connections” chapter. Before switching on the appliance, check that the power supply voltage is within the parameters specified.

The connection of POSYC to peripherals is simplified by the use of standard computer connectors; this means that all standard peripherals for personal computers can be connected via the cable supplied with them or in any case with easily available commercial cables.

In the case of connection of non-standard devices for personal computers such as inverters or other and you need combinations of signals and lengths of customized cables, you can make yourself what you need based on the information provided in the chapter “Connections”.

The following are some recommendations on how to make the cabling for serial communication.

7.2.1 RS485 serial ports wiring

The typical use of RS485 ports is in multipoint configuration, or more devices connected to each other; this type of connection exploits a single pair of conductors and from this it follows that the communication is of the half-duplex type.

Through the RS485 serial ports, up to 32 devices (including the master) can be connected in a single section, offering good noise immunity and a maximum transmission speed.

According to the specifications of the RS485 standard the maximum length of the section is 1200mt at a maximum transmission speed of 100kbps. Please note that the length of the section is inversely proportional to the communication speed.

Through appropriate repeater devices (maximum 9) it is possible to extend the connection and connect up to 126 devices.



For correct operation it is necessary to use a suitable cable, terminating it appropriately. The termination consists in connecting at the beginning and at the end of the section of the resistors with a value of 120ohm; for the beginning and end of the section, the master and the most remote slave are considered respectively (called 1 and 4 in the figure below). The length of the cable connecting the intermediate line (called 2 and 3 in the figure below) must be as short as possible (in any case below 1mt), otherwise the signal quality will be lost. The RS485 serial ports of the POSYC have the termination resistors connected internally.

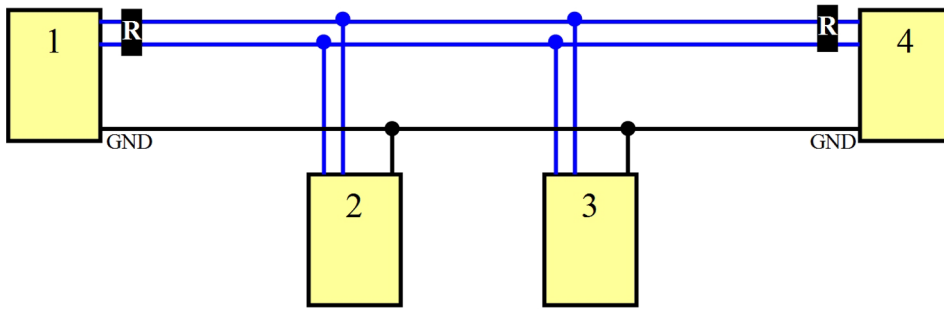

Example of RS485 wiring

An additional conductor with respect to the pair necessary for the communication that connects the masses to each other considerably reduces the probability of failure of the serial ports, especially if they are not isolated, which could form part of equipment with very different ground references.



It is good practice to ground the shield of the cable used only at one end (preferentially from the computer side) to avoid that potential differences between the two devices create a current circulation on the wiring screen, thus introducing communication disturbances; in some applications it is however possible to connect to both ends. The non-connection of the screen to the ground instead (disconnected from both ends) nullifies the function of the screen itself.

7.2.2 RS422 serial port wiring

The use of the RS422 serial port is typically point-to-point like the RS232, but exploits the robustness of the RS485 physical interface; in fact, as the latter can reach considerable distances and speeds. However, unlike the RS485, the RS422 uses two pairs of conductors and can therefore communicate in full-duplex.

	<p>For correct operation, a suitable cable must be used, terminating it appropriately. Termination consists in connecting 120ohm resistors to the end of the section (near the receivers). The RS422 serial port of the POSYC does not have the termination resistors connected to it.</p>
---	--

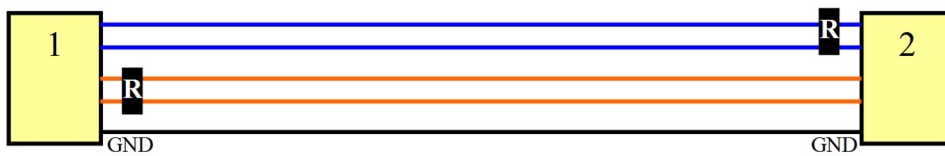

Example of RS422 wiring

An additional conductor with respect to the pair indispensable to the communication that connects the masses to each other, considerably reduces the probability of failures of non-isolated serial ports, which could form part of equipment with very different earth references.

	<p>It is good practice to connect the shield of the cable used only to one end (preferably from the computer side) to prevent potential differences between the two devices from creating a current flow on the wiring screen, thus introducing communication disturbances. In some applications, connection to both ends is still possible. Failure to connect the screen to the ground instead (disconnected from both ends) nullifies the function of the screen itself.</p>
---	---

7.2.3 Serial signals RS485 and RS422 ports

The following figures show the waveforms detected by means of an oscilloscope in different connection situations.

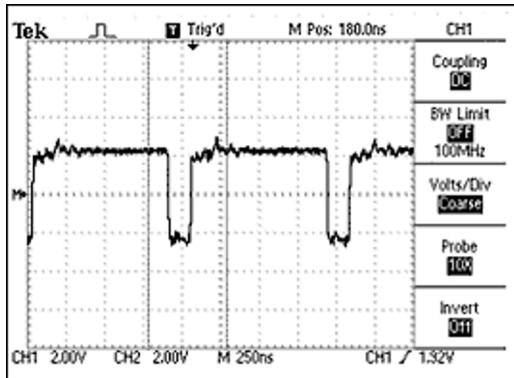

Example of a correct signal

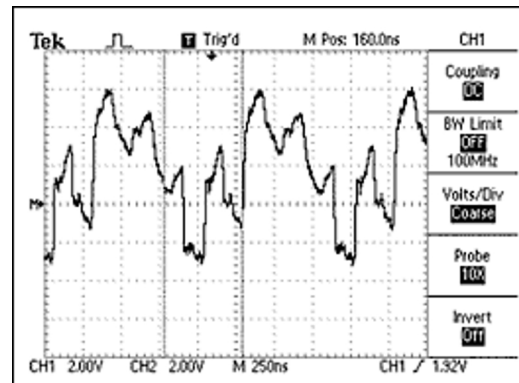

Example of a signal with unfinished lines

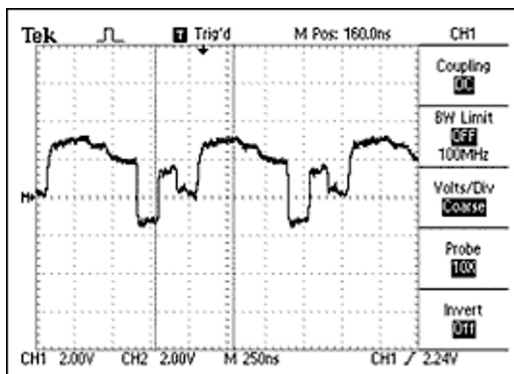

Example of a signal with placed terminations on the wrong device

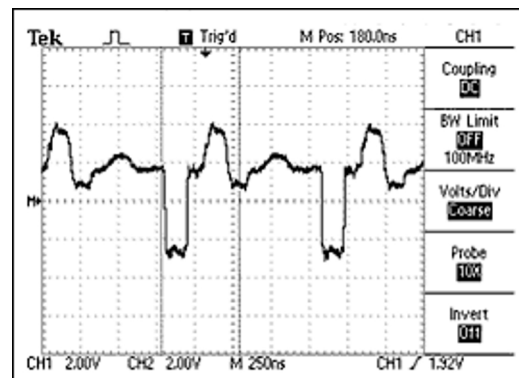

Example of a signal with incorrect value terminations

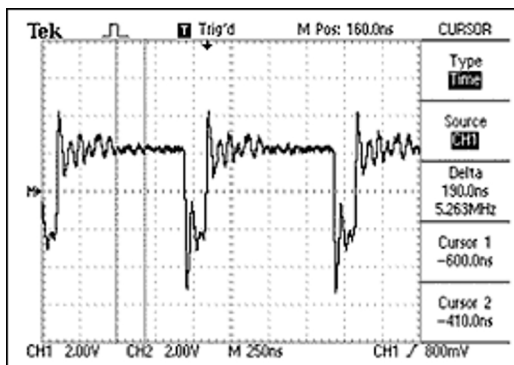

Example of signal on intermediate devices with long connections

8 Use

8.1 Capacitive touch screen

The use of the POSYC computer is completely similar to a normal desktop computer; the only substantial difference is the touch screen pointing device which however allows even more intuitive use of the computer.

ATTENTION



Operate the touch screen sensor exclusively with fingers or non-sharp objects, otherwise it may be damaged.

To operate the touch screen, a slight pressure on it is sufficient (this has the appearance of any glass plate) to command the operating system pointer to move below the area on which the pressure was exerted. Depending on the software settings, the touch screen simulates dragging, clicking, double-clicking and right-clicking. Refer to the software manual for further details.

8.2 USB ports

The USB ports have been designed for connecting temporary devices such as keyboards and flash disks; the silicone cap protecting the USB connectors ensures an IP65 degree of protection towards the inside of the computer as long as it is closed and therefore no port is in use.

ATTENTION



To avoid oxidation damage to the USB connector contacts, once finished using them, protect them again with the appropriate cap to protect them from dust and dirt. The cap guarantees IP65 protection to the USB connectors.

8.3 Flash disk

8.3.1 CFast card for T301/T302/T304/T305

The CFast card available on the T301/T302/T304/T305 models replaces the traditional hard disk, thus giving it greater robustness against impacts and increasing its useful life even in the presence of continuous work cycles.

The positioning of the flash card and the simplicity of extraction/insertion allows for rapid replacement both in the event of a fault and an off-line software update.

The operating system (Windows 10IoT Enterprise Entry) and an empty NTFS partition created to contain any future specific software or data for the T301/T302/T304/T305 models are stored on the supplied flash card.

ATTENTION



To avoid computer failure and/or data loss on the CFast card, the card must be replaced exclusively with POSYC turned off.

8.3.2 Micro SD card for T401/T402/T403

Shock-resistant compared to traditional hard disks and with a position, inside the T401/T402/T403 models, such that extraction/insertion is simple and quick both in the event of a fault and an off-line software update.

The Linux operating system is stored on the supplied micro SD card exclusively for the T401/T402/T403 models.

ATTENTION



To avoid computer failures and/or data loss on the micro SD flash disk, replacement of the same must be carried out exclusively with POSYC turned off.

8.4 Boot device priority

By boot device we mean the mass memories on which the operating system is stored (for example Windows, Linux, etc.) such as CFast cards and SD cards.

By default, POSYC searches for operating system boot information in the mass memory used for the previous boot, for example the CFast, and if it is found, the boot device is not changed; otherwise another one is searched for on other ports, for example USB.

This is a behavior dependent on the working method of the UEFI BIOS.

In normal working conditions it is not necessary, and also not recommended for safety reasons, to start the POSYC from devices other than the supplied CFast/SD.

For exceptional needs such as BIOS update, it is possible to boot the POSYC via USB flash disk; to perform this operation, it will be possible to access the CMOS setup parameters protected by a password for security reasons.

Then with POSYC turned off, insert the USB flash disk into the respective USB 2.0 port and the USB keyboard into the other USB 3.0 port. Turn on the POSYC and change the CMOS Boot settings described below:

1. At start up, when the Smitec logo appears, press **Delete**
2. In the window that appears, enter the password: **STECH**; you enter the CMOS setup menu
3. Modify the parameters by moving between the various sub menus as specified:

- **Boot**
- **Boot Priority 1**
- **SATA 0** replace with **None**

- **Boot Priority 2**
- **None** replace with **USB 2.0 Port 2**

4. Then save the modified parameters in this way:

- **Save & Exit**
- **Save Changes and Reset**
- The window opens automatically: **Save configuration and reset?**
- Confirm with the keyboard: **Yes**

5. The device restarts; then the **fs0:\>** prompt appears
6. Type **UPDATEBIOS KZ0106XX** (where **XX** will be the numbers that will make up the correct device code) and press the **Enter** key; POSYC at this point loads the BIOS
7. Once the BIOS loading is complete, the POSYC restarts entering W10
8. The operation is finished

Be careful not to change any other parameters, otherwise the device will not work.

9 Ordinary maintenance

9.1 Cleaning the touch screen sensor

The touch-screen sensor must be cleaned quite frequently to avoid the stratification of dirt resulting from hands or materials that accidentally come into contact with its surface and to maintain the best possible visibility of the display.

If necessary you can clean the front of the device (keyboard and viewing window) with a very soft cleaning cloth (micro fiber recommended) moistened with water or display cleaning solution.

9.2 Replacing the watch battery

Replacing the internal clock battery, in addition to ensuring its maintenance, is useful for not losing the CMOS Setup settings (basic information for computer operation).

Depending on the climate and how the computer is used, this can have a very variable duration starting from the production date of the POSYC.

It is therefore recommended to carry out preventive replacement of the battery at least every 2 years, taking care to always use the exact model (3V lithium button battery – CR2032).

With the power off, to replace it simply remove the door on the lower part of the computer by unscrewing the 2 cross-head countersunk screws measuring M3x8mm. Gently extract the card on which the battery slot is mounted by sliding it outwards, as shown in the image below. At this point it will be simple to replace the battery with a new one.

If the existing battery is not completely discharged, by carrying out the replacement operation in a few seconds, it will not be necessary to correct the date/time and CMOS Setup settings.

It is important to remember that the old battery that is replaced must be carefully removed from its slot; pay particular attention to the direction of insertion of the new battery, since the latter has a polarity.

In the image below only the 10.1" size model is shown as an example; It is worth pointing out that the battery extraction method is the same for the model with 18.5" display.



Once the new battery has been inserted, insert the card inside the computer and screw back the two screws removed previously.

10 Appendices

10.1 Appendix I: CMOS Setup Parameters

In POSYC 5.0, to guarantee operation, the CMOS Setup parameters are stored in the BIOS.

In the event that there is a loss of CMOS Setup memory, for example following the exhaustion of the buffer battery, these are automatically restored when POSYC is started with the exception of the date and time which can however be reset via the system operating.

If the parameters are mistakenly changed, they can be restored using the **“Restore Defaults”** function in the **“Save & Exit”** menu of the CMOS Setup.

10.2 Appendix II: OS update and/or software installation

For security reasons and to maintain system integrity, the "Windows Module Installer" service is disabled; therefore, if it is necessary to perform operating system updates and/or system software installation, it is recommended to re-enable it only temporarily.

11 Analytical index

Numerics

24Vdc connector 28

A

Absorbed current 13
 Absorbed power 12, 13
 Accessories 21
 Arm mounting 33

B

Basic hardware 18
 Boot device priority 40
 Bottom view 22

C

Capacitive touch screen 39
 CFast card 18, 40
 Cleaning the touch screen sensor 42
 CMOS Setup Parameters 44
 COM1 serial port 18
 COM2 serial port 18
 Connections 22
 Current consumption 12

D

Display model 18

E

Electrical characteristics 12
 Electrical connections 35
 Environmental specifications 12
 Ethernet ports 18, 30

F

Fixing 13
 Flash disk 40
 Front view 31

I

Installation 32

L

LED status 31

M

Main power supply voltage 12, 13
 Maximum altitude 12
 Mechanical characteristics 13
 Memory 18
 Micro SD 40

O

Operating temperature 12
 Order code 20
 Ordinary maintenance 42

P

POSYC status 31
 Processor 18
 Product description 8
 Protection degree 12

R

Rear view 26
 Relative humidity 12
 Replacing the watch battery 42
 RS422 serial port wiring 37
 RS422/485 serial ports 29
 RS485 serial ports wiring 35

S

Safety instructions 7
 Specialized personnel 4
 Storage temperature 12

T

Technical data 12
 Touch screen sensor 18

U

USB ports 18, 39
 Use 39
 User 4
 User/operator 4
 Using SW1 button 23

W

Weight 13